

Notes on  
**Jeremiah**  
2006 Edition  
Dr. Thomas L. Constable

## Introduction

### TITLE

The title of this book derives from its writer, the late seventh and early sixth-century Judean prophet Jeremiah. The book occupies the second position in the Latter Prophets section of the Hebrew Bible after Isaiah and before Ezekiel, which accounts for its position in the Septuagint and most modern translations.

The meaning of "Jeremiah" is not clear. It could mean "Yahweh founds (or establishes)," "Yahweh exalts," "Yahweh throws down," "Yahweh hurls," or "Yahweh loosens (the womb)."

### WRITER

The composition and structure of Jeremiah, discussed below, have led many scholars to conclude that an editor or editors (redactors) probably put the book in its final form. Many conservatives, however, believe that Jeremiah himself was responsible for the final form, though it is clear that the book went through several revisions before it reached its final canonical form. Jeremiah could even have written the last chapter, which describes events that took place about 25 years after the next latest events, since he would have been approximately 83 years old, assuming he was still alive. Clearly, Jeremiah's secretary, Baruch, provided the prophet with much assistance in writing the material and possibly arranging it in its final form (36:17-18; 45:1). Baruch was to Jeremiah what Luke was to Paul: his companion, amanuensis, and biographer. The book bears marks of having been assembled by one person at one time.

"There is no satisfactory reason for doubting that Jeremiah himself was the author of the entire book."<sup>1</sup>

The Book of Jeremiah tells us more about the prophet Jeremiah than any other prophetic book reveals about its writer. It is highly biographical and autobiographical.<sup>2</sup> We know more about his personality than that of any other prophet.

---

<sup>1</sup>Edward J. Young, *An Introduction to the Old Testament*, p. 243. See also Eugene H. Merrill, *Kingdom of Priests: A History of Old Testament Israel*, p. 458.

<sup>2</sup>Scholars refer to the autobiographical sections (10:23-25; 11:18—12:6; 15:10-14, 15-21; 17:9-11, 14-18; 18:18-23; and 20:7-13, 14-18) as "Jeremiah's confessions." E.g., John F. Graybill, "Jeremiah," in *The Wycliffe Bible Commentary*, p. 656; J. A. Thompson, *The Book of Jeremiah*, pp. 88-92.

Jeremiah's hometown was Anathoth, a Levitical town in the territory of Benjamin three miles northeast of Jerusalem.<sup>3</sup> Jeremiah's father, Hilkiah, was evidently a descendant of Abiathar, a descendant of Eli (1 Sam. 14:3). Thus Jeremiah had ancestral connections to Shiloh, where the tabernacle stood during the judges period of Israel's history (the amphictyony). Jeremiah referred to Shiloh in his Temple Sermon (7:12, 14; 26:6). Abiathar was the sole survivor of King Saul's massacre of the priests at Nob, also only a few miles northeast of Jerusalem (1 Sam. 22:20). Later Solomon exiled Abiathar to Anathoth, where Abiathar had property, because Abiathar had proved unfaithful to David (1 Kings 2:26). Jeremiah's father Hilkiah may have been the high priest who found the book of the Law in the temple during Josiah's reforms (1 Kings 2:26).<sup>4</sup> Even though Jeremiah came from a priestly family (like Ezekiel and Zechariah), there is no indication that he ever underwent training for the priesthood or functioned as a priest.

Jeremiah's date of birth is a matter of dispute. Most scholars believe he was born about 643 B.C., one year before the end of King Manasseh's reign.<sup>5</sup> He probably died in Egypt.

"A late, unattested tradition, mentioned by Tertullian, Jerome, and others, claims that the people of Tahpanhes [in Egypt] stoned Jeremiah to death."<sup>6</sup>

His call to the prophetic office came in 627 B.C. (1:2; 25:3) when he would have been about 20 years old.<sup>7</sup> His ministry as a prophet may have extended over 40 years.<sup>8</sup> He evidently exercised his ministry mainly during periods of crisis in Judah's history, though it is impossible to date some of his prophecies. His ministry involved prophesying about Judah and the other ancient Near Eastern nations of his time (1:10).

Judging by Jeremiah's autobiographical remarks and the narrative information about him in this book, his life was a sad one, one long martyrdom. He probably encountered more opposition from more enemies than any other prophet. Much of it stemmed from his message to his own people: unconditional surrender to Babylon.

"No braver or more tragic figure ever trod the stage of Israel's history than the prophet Jeremiah. . . .

<sup>3</sup>See the map of Palestine at the end of these notes.

<sup>4</sup>R. K. Harrison, *Introduction to the Old Testament*, p. 802.

<sup>5</sup>For a clear discussion of the problem, see Thompson, pp. 50-56. See Edwin R. Thiele, *A Chronology of the Hebrew Kings*, p. 75, for the dates of Israel and Judah's kings. The commentators give dates that sometimes vary by one or two years when describing the same events. This is because the Babylonians used one method of dating and the Israelites another, at least for some periods of their history. There is still some confusion about these dates. I have usually followed the scheme set forth by Thiele.

<sup>6</sup>Charles Lee Feinberg, "Jeremiah," in *Isaiah-Ezekiel*, vol. 6 of *The Expositor's Bible Commentary*, p. 360.

<sup>7</sup>See my comments on 1:6.

<sup>8</sup>Several reliable scholars believed that Jeremiah's ministry ended about 587 B.C. or a little later. See, for example, Peter C. Craigie, *Jeremiah 1—25*, p. xlv; Merrill, p. 467; and Thompson, p. 116. Charles H. Dyer, "Jeremiah," in *The Bible Knowledge Commentary: Old Testament*, p. 1123; and Leon J. Wood, *The Prophets of Israel*, p. 330, believed it continued to at least 582 B.C. Craigie, by the way, wrote only the commentary on 1:1—8:3 and the Introduction in this volume. Dyer usually provided good explanations of time references that occur throughout Jeremiah.

"Jeremiah was hated, jeered at, ostracized (e.g., chs. 15:10f., 17; 18:18; 20:10), continually harassed, and more than once almost killed (e.g., chs. 11:18 to 12:6; 26; 36)."<sup>9</sup>

Jeremiah is the only prophet who recorded his own feelings as he ministered, which makes him both very interesting and very helpful to other ministers. Some authorities believe that his greatest contribution to posterity is his personality.

". . . by birth a priest; by grace a prophet; by the trials of life a bulwark for God's truth; by daily spiritual experience one of the greatest exponents of prophetic faith in his unique relation to God; by temperament gentle and timid, yet constantly contending against the forces of sin; and by natural desire a seeker after the love of a companion, his family, friends, and above all, his people—which were all denied him."<sup>10</sup>

"He was a weeping prophet to a wayward people."<sup>11</sup>

There are many similarities between Jeremiah and Hosea. Hosea announced the fall of Samaria, and Jeremiah announced the fall of Jerusalem. Both prophets experienced much personal tragedy. In his ideas as well as in his vocabulary, Jeremiah demonstrates familiarity with Hosea's prophecies. There are also affinities with Job and the Psalter.

There are also remarkable parallels between Jeremiah and the Lord Jesus Christ. No other prophet bears as many striking similarities to the Savior, which makes him the most Christ-like of the prophets. The people of Jesus' day noted these similarities (Matt. 16:14). In both cases Jerusalem was about to fall, the temple would suffer destruction soon, the worship of Yahweh had become a formalistic husk, and there was need for emphasis on individual relationship with God. Both men had a message for Israel and the whole world. Both of them used nature quite extensively for illustrative purposes in their teaching. Both came from a high tradition: Jeremiah from a priestly, prophetic heritage and Jesus from a divine, royal position. Both were very conscious of their call from God. Both condemned the commercialism of temple worship in their day (7:11; Matt. 21:13). Their enemies charged both of them with political treason. Both experienced persecutions, trials, and imprisonments. Both foretold the destruction of the temple (7:14; Matt. 13:2). Both wept over Jerusalem (9:1; Luke 19:41). Both condemned the priests of their day. Both experienced rejection by members of their own families (12:6; John 1:11). Both were so tenderhearted that some Jewish leaders identified them with the Suffering Servant of Isaiah 53. Both loved Israel deeply. Both were lonely (15:10; Isa. 53:3). And both enjoyed unusually intimate fellowship with God (20:7; John 11:41-42).<sup>12</sup>

"It has often been remarked that Jeremiah's life was finally a failure. He was alone for most of his ministry. It seemed that no one gave any heed to

---

<sup>9</sup>John Bright, *A History of Israel*, pp. 313, 314.

<sup>10</sup>Feinberg, p. 358.

<sup>11</sup>Dyer, p. 1123.

<sup>12</sup>Feinberg, p. 361.

his words. He was dragged off finally to live his last days in exile against his own will. He was a failure as the world judges human achievement. But a more balanced assessment of him would be that his very words of judgment saved Israel's faith from disintegration, and his words of hope finally helped his people to gain hope in God's future for them."<sup>13</sup>

"The character of Jeremiah is also reflected in his writings. His speech is clear and simple, incisive and pithy, and, though generally speaking somewhat diffuse, yet ever rich in thought. If it lacks the lofty strain, the soaring flight of an Isaiah, yet it has beauties of its own. It is distinguished by a wealth of new imagery which is wrought out with great delicacy and deep feeling, and by 'a versatility that easily adapts itself to the most various objects, and by artistic clearness' (Ewald)."<sup>14</sup>

### **HISTORICAL BACKGROUND**

The biblical records of the times in which Jeremiah ministered are 2 Kings 21—25 and 2 Chronicles 33—36. His contemporary prophets were Zephaniah and Habakkuk before the Exile, and Ezekiel and Daniel after it began.

King Manasseh had been Judah's most ungodly king, but toward the end of his life he repented (2 Chron. 33:15-19). He was responsible for many of the evil conditions that marked Judah in Jeremiah's earliest years (cf. 15:4; 2 Kings 23:26). His long life was not a blessing for faithfulness, as his father Hezekiah's had been, but an instrument of chastening for Judah.

King Amon succeeded Manasseh and reigned two years (642-640 B.C.). Rather than perpetuating the repentant attitude that his father had demonstrated, Amon reverted to the policies of Manasseh's earlier reign and rebelled against Yahweh completely. This provoked some of his officials to assassinate him (2 Kings 21:23).

Josiah was eight years old when his father Amon died. He began reigning then and continued on the throne for 31 years (640-609 B.C.). Josiah was one of Judah's best kings and one of the four reforming kings of the Southern Kingdom. He began to seek the Lord when he was 16 years old and began initiating religious reforms when he was 20 (2 Chron. 34:3-7). Jeremiah received his call to minister in the thirteenth year of Josiah when the king was 21, namely, 627 B.C. (1:6). Josiah's reforms were more extensive than those of any of his predecessors. He began the major projects when he was 26. During these years Assyria was declining as a world power and Neo-Babylonia was not yet the dominant empire it soon became. One of Josiah's projects was the repairing of Solomon's temple (v. 5; cf. 12:4-16). During its renovation Hilkiah, the high priest and possibly Jeremiah's father, discovered the Mosaic Law, which had been lost for a long time (cf. 2 Kings 22:8). This discovery spurred a return to the system of worship that the Book of

---

<sup>13</sup>Thompson, p. 106.

<sup>14</sup>C. F. Keil, *The Prophecies of Jeremiah*, 1:19. For good summaries of Jeremiah's life, see *ibid.*, 1:11-20; Thompson, pp. 94-106; and Bright, pp. 313-15.

Deuteronomy specified (2 Kings 23). Josiah also did much to clear the land of idolatry, sacred prostitution, child sacrifice, and pagan altars not only in Judah but also in some formerly Israelite territory. He also reinstated the Passover. Unfortunately for Judah, Josiah felt compelled to travel to Megiddo to try and block Pharaoh Neco II from advancing north to assist the Assyrians in resisting the westward expanding Babylonians. Josiah died at Megiddo in 609 B.C. at the age of 39. His death was a tragic loss for Judah.

Some of Jeremiah's prophecies date from Josiah's reign.<sup>15</sup> Zephaniah also ministered in Judah during the reign of Josiah, as did the prophetess Huldah (2 Kings 22:14-20).

Three of Josiah's sons and one of his grandsons ruled Judah after his death. The first of these, though he was the second son, was Jehoahaz, who ruled for only three months in 609 B.C. The Judean people favored Jehoahaz, but Pharaoh Neco, who by slaying Josiah gained control over Judah, found him uncooperative. Therefore, Pharaoh deported Jehoahaz to Egypt as a prisoner where he died (22:10-12). God gave Jeremiah a few prophecies during this king's brief reign.

### The Last Five Kings of Judah

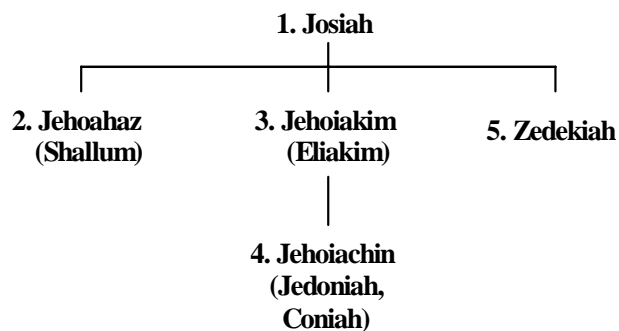

Jehoahaz's older brother Jehoiakim succeeded him on Judah's throne, thanks to Pharaoh Neco. He reigned for 11 years (609-598 B.C.). Jehoiakim was a weak king who changed allegiances between Egypt and Babylon whenever he thought a change might be to Judah's advantage. During his tenure Prince Nebuchadnezzar of Babylon defeated the allied Egyptian and Assyrian forces at Carchemish thus establishing Babylonian supremacy in the ancient Near East (605 B.C.). Shortly thereafter King Nebuchadnezzar, as he had become, invaded Palestine, conquered some cities, and took some of the nobles, including Daniel, as exiles to Babylon (Dan. 1:1-3). Jehoiakim refused to follow Jeremiah's counsel to submit to the Babylonians. Instead he showed his contempt for the prophet by burning his prophecies (ch. 36). Jeremiah despised this king for his wickedness (22:18-19; 26:20-23; 36). Jehoiakim rebelled against Babylon in 601 B.C., so the Babylonians deposed him and took him to Babylon (2 Chron. 36:6). Later they allowed him to return to Jerusalem where he died in 561 B.C. (cf. 22:19). Several of Jeremiah's prophecies apparently date from Jehoiakim's reign. Habakkuk probably also ministered at this time, as the content of his book suggests.

<sup>15</sup>There have been many attempts to date all the various sections of Jeremiah. However much of this is guesswork, and even conservative commentators disagree about the dating of many sections of the book. See the chart "The Dating of Jeremiah's Prophecies" in *The Bible Knowledge Commentary: Old Testament*, p. 1126; Young, pp. 250-55; Thompson, pp. 27-30; Feinberg, p. 367; R. K. Harrison, *Jeremiah and Lamentations: An Introduction and Commentary*, p. 33; and Derek Kidner, *The Message of Jeremiah*, pp. 173-75; for various schemes.

Jehoiakim's son Jehoiachin succeeded his father but only reigned for three months (598-597 B.C.). During that time Nebuchadnezzar attacked Jerusalem and carried off a large portion of the city's population (in 597 B.C.). The king was evil, and Jeremiah predicted that none of his sons would rule over the nation (22:30). He ended his days in Babylon enjoying the favor of the Babylonian king Evilmerodach (52:31-34).

Zedekiah was the third son of Josiah to rule Judah, and he too ruled under Nebuchadnezzar's sovereignty (597-586 B.C.). The Babylonian monarch summoned Zedekiah to Babylon in 593 B.C. (51:59), but he rebelled against Nebuchadnezzar by making a treaty with Pharaoh Hophra (589-570 B.C.) under pressure from Judean nationalists (chs. 37—38). This resulted in the final siege of Jerusalem in 588 and its fall two years later in 586 B.C. (ch. 39).<sup>16</sup> The Babylonians took Zedekiah captive to Riblah in Syria where they slew his sons and put out his eyes. He died later in Babylon. Since Jeremiah advocated surrender to the Babylonians, Nebuchadnezzar allowed him to choose where he wanted to live when Jerusalem fell, and the prophet elected to stay where he was.

Shortly after he defeated Zedekiah, Nebuchadnezzar set up a pro-Babylonian Judean named Gedaliah as his governor of Judah (40:5-6). But a group of Jewish nationalists under Ishmael's leadership assassinated Gedaliah within the year (586 B.C.; 41:2). This ill-advised act resulted in the rebels having to flee to Egypt for safety from Nebuchadnezzar. They forced Jeremiah to accompany them against his will (chs. 42—43). There the prophet evidently spent the remaining years of his life and produced his final prophecies.<sup>17</sup>

<b>IMPORTANT DATES FOR JEREMIAH</b>		
<b>Years</b>	<b>Events</b>	<b>References</b>
643	Probable date of Jeremiah's birth	
640	Josiah becomes king of Judah at age 8	2 Chron. 34:1
628	Josiah begins his reforms	2 Chron. 34:3
627	Jeremiah begins his ministry	Jer. 1:2; 25:3
626	Nabopolassar founds the Neo-Babylonian Empire	
622	The book of the Law discovered in the temple	2 Chron. 34:8, 14
612	The fall of Nineveh, Assyria's capitol	
609	Josiah killed in battle by Egyptians at Megiddo	2 Chron. 35:20-25
	Jehoahaz reigns over Judah for 3 months	2 Chron. 36:1-3
	Jehoiakim made king of Judah by Pharaoh Necho	2 Chron. 36:4

<sup>16</sup>Some writers date the fall of Jerusalem in 587 B.C. See, for example, Rodger C. Young, "When Did Jerusalem Fall?" *Journal of the Evangelical Theological Society* 47:1 (March 2004):21-38.

<sup>17</sup>All of the major commentaries on Jeremiah, Old Testament Introductions, and Histories of Israel contain explanations of the historical background of the book, which see for further detail.

<b>IMPORTANT DATES FOR JEREMIAH</b>		
<b>Years</b>	<b>Events</b>	<b>References</b>
605	Nebuchadnezzar defeats the Egyptians at Carchemish	Jer. 46:2
	The first deportation of exiles (including Daniel) to Babylon	Dan. 1:1-7
604	Jehoiakim burns Jeremiah's first scroll	Jer. 36
601	Jehoiakim rebels against Babylon	2 Kings 24:1
598	Jehoiakim is deposed and dies	2 Chron. 36:3
	Jehoiachin reigns over Judah for 3 months	2 Kings 24:8
597	The second deportation of exiles (including Jehoiachin) to Babylon	2 Kings 24:12-16
	Zedekiah made king of Judah by Nebuchadnezzar	2 Kings 24:17
593	Zedekiah summoned to Babylon	Jer. 51:59
588	Zedekiah is besieged in Jerusalem for treachery	Jer. 52:3-4
586	Fall of Jerusalem	Jer. 39
	Gedaliah appointed governor of Judah by Nebuchadnezzar	Jer. 40:5-6
	Gedaliah assassinated by Ishmael	Jer. 41:2
	Judean refugees flee to Egypt taking Jeremiah with them	Jer. 42—43
581	The third deportation of exiles to Babylon	Jer. 52:30
568	Nebuchadnezzar invades Egypt	Jer. 43:8-13; 46:13-26
561	Jehoiachin released from prison in Babylon	Jer. 52:31-34
539	Fall of Babylon to Cyrus the Persian	Dan. 5:30
538	Cyrus issues his decree allowing the Jews to return to Palestine	Ezra 1:1-4

### **DATE**

As has already been pointed out, Jeremiah gave the prophecies and composed the narratives that constitute this book at various times during his long ministry. The date at which the book reached the state in which it is today is debatable. Most scholars believe that editors continued to add and rearrange the material long after Jeremiah's day. However, the tradition that Jeremiah was responsible for the book is old and has encouraged many conservative scholars to view it as the product of the prophet himself or perhaps his scribe Baruch. If Jeremiah was the final editor of the work, as well as its writer, he completed this editorial task after his last historical reference and before his

death. The last historical reference is Jehoiachin's release from captivity in Babylon (561 B.C.; 52:31-34). We do not know when Jeremiah died, but if he was born about 643 B.C., he probably did not live much beyond 560 B.C. Some scholars believe Jeremiah wrote this account himself or that Baruch provided it. Others believe the writer of the Book of Kings added it to the collections of Jeremiah's writings.<sup>18</sup> One writer speculated that the final canonical form of the book was in circulation not later than 520 B.C.<sup>19</sup> Another believed it was available shortly after Jeremiah's death, which he guessed was about 586 B.C.<sup>20</sup>

### **AUDIENCE**

Jeremiah ministered to the people of Judah during the last days of the monarchy and the early part of the captivity. Almost all his ministry took place in Jerusalem. He spoke to kings, priests, and prophets, as well as the ordinary citizens, and he delivered oracles against foreign nations.

"The book of Jeremiah and the book of Lamentations show how God looks at a culture which knew Him and deliberately turned away."<sup>21</sup>

### **PURPOSE**

Jeremiah's purpose was to call his hearers to repentance in view of God's judgment on Judah, which would come soon from an army from the north (chs. 2—45). Judgment was coming because God's people had forsaken Yahweh and had given themselves to idolatry. Jeremiah spoke more about repentance than any other prophet. He also assured his audience that God had a future for Israel and Judah (chs. 30—33). Once it became clear that the people would not repent, he advocated submission to Babylon to minimize the destruction that was inevitable. As God's prophetic spokesman, he also uttered oracles against the nations that opposed God's chosen people (chs. 46—51).

"The theme of this prophet consists largely in a stern warning to Judah to turn from idolatry and sin to avoid the catastrophe of exile."<sup>22</sup>

### **THEOLOGICAL EMPHASES**

The Book of Jeremiah is not theologically organized in the sense that it develops a certain theological emphasis as it unfolds, as Isaiah does. Rather it presents certain theological truths in greater or lesser degree throughout its 52 chapters. The dominant theological emphases are as follows.

The prophet paid more attention to God and the Israelites than to any other subjects of revelation. His appreciation for God as the Lord of all creation is noteworthy. In contrast

---

<sup>18</sup>E.g., Dyer, p. 1123.

<sup>19</sup>Harrison, *Jeremiah and . . .*, p. 32.

<sup>20</sup>Feinberg, p. 362.

<sup>21</sup>Francis A. Schaeffer, *Death in the City*, p. 16.

<sup>22</sup>Gleason L. Archer Jr., *A Survey of Old Testament Introduction*, p. 359. See also Young, pp. 248-49.



to Isaiah, Micah, Zechariah, and Daniel, Jeremiah did not reveal much about the coming Messiah, though he did record a few significant messianic predictions. A coming revealer would outshine the ark of the covenant (3:14-17), and the fulfillment of the Davidic Covenant promises would come (33:14-26).

Regarding the Israelites, Jeremiah stressed the fact that immorality always accompanies idolatry. Israel's present problems were the result of her past and present apostasy. The priests, Jeremiah asserted, were primarily responsible for the degeneration of worship from spiritual to merely formal, though several false prophets also misled the people. The Judahites could not escape going into captivity because they refused to repent. Therefore, they needed to accept the inevitable and not resist the Babylonians. Jerusalem and Judah would suffer destruction, the Davidic kings would not rule (for some time), and the Israelites would lose their land (temporarily). But there would be a return from exile (25:11; 29:10). Israel had hope of a glorious future in view of God's faithfulness to His promises (32:1-15). In the distant future, Israel would return in penitence to the Lord (32:37-40). Messiah would rule over her (23:5-8).

". . . Jeremiah placed an enormous emphasis on the sins and misdeeds of Israel. . . .

"The evil deeds in which Israel was involved were of two broad classes—the worship of false gods, and the perpetration of personal and social sins of an ethical and moral kind."<sup>23</sup>

"The theology of the book of Jeremiah may be summarized as follows: God's judgment would fall on Judah because she had broken His covenant."<sup>24</sup>

The nations were God's agents in executing His will, particularly Nebuchadnezzar (27:6). But Babylon would fall (chs. 50—51). The nations, as well as Israel, needed to demonstrate righteousness (chs. 46—51). God had a concern for the nations as well as for His people (29:1-14). In the distant future, the remnant of the nations would enjoy blessing from the Lord (3:17; 16:19).

There is also a strong emphasis on the biblical covenants in Jeremiah, particularly the Mosaic and New Covenants. Jeremiah viewed Israel as the chosen people of God adopted by Him for a special relationship with Himself and for a special purpose in the world. The Mosaic Covenant was pure grace, and Yahweh had made it with a redeemed people. It involved promises from God and responsibilities for the Israelites that required trust, obedience, and holiness. Obedience would result in blessing from God, and disobedience would yield divine cursing. The prophet knew the Mosaic Law and compared the conduct of the people to what it required.<sup>25</sup> Jeremiah anticipated the appearing of the promised

---

<sup>23</sup>Thompson, pp. 110, 111.

<sup>24</sup>Robert B. Chisholm Jr., "A Theology of Jeremiah and Lamentations," in *A Biblical Theology of the Old Testament*, p. 342.

<sup>25</sup>This feature is so prominent that some scholars have argued that someone from the so-called Deuteronomistic School composed or edited the book. Writers identified as Deuteronomistic in their emphasis, especially writers of the books of Joshua through 2 Kings, consistently compared the conduct of the Israelites to what God required in the Mosaic Law, which was Moses' practice in Deuteronomy.

Davidic Messiah and the fulfillment of the kingdom promises that God had made to David. He also predicted that God would make a new covenant with the Israelites sometime in the future that would involve new provisions and conditions for living (31:31-34). It would replace the old Mosaic Covenant and would feature personal relationship with God to an extent never experienced before.

"Probably the outstanding emphasis in Jeremiah's ministry was the priority of the spiritual over everything else. He saw how secondary the temporal features of Judah's faith were. . . .

"The lasting value of Jeremiah's book lies not only in the allusions (between forty and fifty of them) in the NT (over half are in Revelation) but also in its being a wonderful handbook for learning the art of having fellowship with God."<sup>26</sup>

### COMPOSITION

The present canonical form of the book was probably the result of a long and complex process of collection. The Book of Psalms also underwent compilation in a similar fashion over many years. The compilation is not chronological, but it did occur in stages.

"Precisely how the final form of the prophecy arose is unknown."<sup>27</sup>

In some cases key words link units of material together. There is also some grouping of subject matter according to genre within the larger sections of the book.<sup>28</sup>

The attempt to identify the original sources of material in Bible books is a worthy subject of study, but the purpose of these notes is to expound the text.<sup>29</sup> The book itself indicates that King Jehoiakim destroyed some of Jeremiah's earlier written prophecies and that Baruch rewrote them and added more to form another collection (ch. 36). This information explains to some extent the anthological structure of the book and suggests that Jeremiah, Baruch, and perhaps others added even more prophecies as time passed and that the final product is what we have.

"It is clear that the book assumed its present form either very late in the prophet's lifetime, or more probably after his death."<sup>30</sup>

---

<sup>26</sup>Feinberg, pp. 369-70. Most of the allusions to Jeremiah in Revelation deal with the coming fall of Babylon. For more extensive discussions of Jeremiah's theological emphases, I recommend Harrison, *Jeremiah and . . .*, pp. 37-42; Thompson, pp. 107-13; and Kidner, pp. 163-72.

<sup>27</sup>Harrison, *Jeremiah and . . .*, p. 32.

<sup>28</sup>See Dyer, pp. 1127-28.

<sup>29</sup>See the major commentaries on Jeremiah for further discussion of how the present canonical form of the text came into existence. I recommend especially Thompson, pp. 33-50.

<sup>30</sup>Craigie, p. xxxiii.

## GENRE

About half of Jeremiah is poetry and half prose. But poetry and prose appear side by side in many sections of the book; several literary units contain both forms of composition.

Scholars have identified three types of literature (genre) in Jeremiah: poetic sayings or oracles (so-called Type A material), prose narratives that are largely biographical and historical (so-called Type B material), and prose speeches or discourses (so-called Type C material).<sup>31</sup>

Several generations of scholars have held that the poetic oracles toward the first part of the book represent Jeremiah's original sayings, and the historical and biographical narratives that follow were the product of Baruch, Jeremiah's scribe. This view, while a common one, contains serious problems, and many competent authorities have pointed out the inconsistencies of this position. I mention it here because it is a common view, not because I accept it. I do not.<sup>32</sup>

## STRUCTURE

Like most other prophetic books of the Old Testament, Jeremiah is a collection of oracles and other materials. It is an anthology of Jeremiah's speeches and writings, really an anthology of anthologies. It is not like a novel that one may read from start to finish discovering that it unfolds in a logical fashion as it goes.

"No commentator, ancient or modern, has seriously posited a chronological arrangement of its prophecies."<sup>33</sup>

This book, even more than most of the other prophetic books, strikes the western mind initially as not following any consistently logical order, especially within the body of the book. The difficulty that students of Jeremiah have had in discovering its underlying plan is clear from the fact that commentators have offered so many different outlines of it.<sup>34</sup>

"When we come to inquire whether any principles of arrangement can be observed in the book of Jeremiah, we have to admit that any consistent principles escape us."<sup>35</sup>

". . . it is often difficult to see why certain passages occur at precisely the point where they do occur."<sup>36</sup>

---

<sup>31</sup>Sigmund Mowinckel labeled the three types A, B, and C in *Zur Komposition des Buches Jeremia* (1914) following the earlier work of Bernhard Duhm in *Das Buch Jeremia* (1901), and commentators make frequent reference to the genre by these types.

<sup>32</sup>For further discussion of the different genres in Jeremiah, see C. Hassell Bullock, *An Introduction to the Old Testament Prophetic Books*, pp. 204-6.

<sup>33</sup>Feinberg, p. 367. He argued for an essentially topical arrangement of the material.

<sup>34</sup>Harrison even provided two different outlines of the book in his Old Testament Introduction and in his commentary on Jeremiah.

<sup>35</sup>Thompson, p. 30.

<sup>36</sup>Young, p. 249.

## **DISTINCTIVE FEATURES**

In addition to the lack of a clear organizing plan, Jeremiah is quite repetitive. The repetition is for emphasis, no doubt, and many very similar passages occur two and even three times.

The last chapter is unique because someone must have written it long after the rest of the book. The options are that Jeremiah or Baruch wrote it or that some other writer added it later. There is no way to tell for sure who wrote it or when, but its purpose seems clear enough. It provides hope at the end of a record of discouraging circumstances.

The biographical and autobiographical sections of the book are also distinctive. No other prophet wrote as much about himself and his experiences as Jeremiah did, and no other prophet let us into his head and his heart as much as he did by sharing how he thought and felt.

Jeremiah used object lessons to communicate spiritual truth more than the other prophets. He made his prophecies concrete and vivid by this means. He did not delight to paint word pictures as much as Isaiah did, but he performed acts and spoke of real situations far more than that earlier prophet did.

## **TEXT**

The history of the textual transmission of Jeremiah is unusual. The Septuagint (Greek) translation, made in the third and second centuries B.C. in Alexandria, Egypt, is about one-eighth shorter than the Masoretic Text (the Hebrew text formalized in the fifth century A.D. that is the basis for the modern Hebrew Bible and our English translations). In addition to being shorter, the arrangement of material in the book is in a different order in several places. The Septuagint version of Jeremiah differs from the Hebrew more widely than is true of any other Old Testament book. There are omissions, additions, transpositions, alterations, and substitutions.<sup>37</sup>

Probably the Septuagint translators worked from a different version of Jeremiah than the one that was the basis for the Masoretic Text.<sup>38</sup> The Septuagint was the Bible of most of the early Christians, especially those who lived outside Palestine. Which version is more reliable, the shorter one that they used (and quoted in the New Testament) or the longer one that we have? Most conservative scholars believe that the Masoretic Text has a solid history and is more reliable than the Septuagint. The differences between these two versions are not significant in terms of theology. We do not have contradictions between what the New Testament writers quoted as being from Jeremiah and what we read in our English translations of Jeremiah.<sup>39</sup>

---

<sup>37</sup>See G. C. Workman, *The Text of Jeremiah*, pp. 18-181; Emanuel Tov, "The Literary History of the Book of Jeremiah in the Light of Its Textual History," in *Empirical Models for Biblical Criticism*, pp. 211-37.

<sup>38</sup>Some Dead Sea Scroll fragments of Jeremiah point to the existence of such a version.

<sup>39</sup>See Feinberg, p. 372; Thompson, pp. 117-20; or Craigie, pp. xli-xlv; for further discussion, or Chisholm, p. 342, n. 1, for a concise summary.

**OUTLINE**

- I. Introduction ch. 1
  - A. The introduction of Jeremiah 1:1-3
  - B. The call of Jeremiah 1:4-19
    - 1. The promise of divine enablement 1:4-10
    - 2. Two confirming visions 1:11-19
- II. Prophecies about Judah chs. 2—45
  - A. Warnings of judgment on Judah and Jerusalem chs. 2—25
    - 1. Warnings of coming punishment because of Judah's guilt chs. 2—6
    - 2. Warnings about apostasy and its consequences chs. 7—10
    - 3. Warnings in view of present conditions 11:1—15:9
    - 4. Warnings in view of Judah's hardheartedness 15:10—25:38
  - B. Controversies concerning false prophets chs. 26—29
    - 1. Conflict with the people ch. 26
    - 2. Conflict with the false prophets in Jerusalem chs. 27—28
    - 3. Conflict with the false prophets in exile ch. 29
  - C. The Book of Consolation chs. 30—33
    - 1. The restoration of all Israel chs. 30—31
    - 2. The restoration of Judah and Jerusalem chs. 32—33
  - D. Incidents surrounding the fall of Jerusalem chs. 34—45
    - 1. Incidents before the fall of Jerusalem chs. 34—36
    - 2. Incidents during the fall of Jerusalem chs. 37—39
    - 3. Incidents after the fall of Jerusalem chs. 40—45
- III. Prophecies about the nations chs. 46—51
  - A. The oracle against Egypt ch. 46
  - B. The oracle against the Philistines ch. 47
  - C. The oracle against Moab ch. 48
  - D. The oracle against Ammon 49:1-6
  - E. The oracle against Edom 49:7-22
  - F. The oracle against Damascus 49:23-27
  - G. The oracle against the Arab tribes 49:28-33
  - H. The oracle against Elam 49:34-39
  - I. The oracle against Babylon chs. 50—51

- IV. Conclusion ch. 52.
  - A. The fall of Jerusalem and the capture of Zedekiah 52:1-16
  - B. The sacking of the temple 52:17-23
  - C. The numbers deported to Babylon 52:24-30
  - D. The release of Jehoiachin from prison 52:31-34

## Exposition

### I. INTRODUCTION CH. 1

The first chapter of this great book introduces the prophet to the reader and records his calling by Yahweh into the prophetic ministry.

#### A. THE INTRODUCTION OF JEREMIAH 1:1-3

Most of the prophetic books begin with some indication of authorship and date to put them in their historical contexts, and this is true of the Book of Jeremiah.

- 1:1 The "words" (Heb. *debarim*, writings, prophecies, deeds, and events of his life) that follow are those of Jeremiah (meaning Yahweh founds, establishes, exalts, throws down, hurls, or loosens [the womb]).<sup>40</sup> His father was Hilkiyah who may or may not have been the high priest who found the book of the Law in the temple during Josiah's reforms (1 Kings 2:26).<sup>41</sup> Jeremiah's father was a priest who lived in Anathoth, a village three miles northeast of Jerusalem in the territory of Benjamin where other priests also lived (cf. Josh. 21:15-19). Thus Jeremiah was a priest by ancestry.<sup>42</sup>
- 1:2 The word of Jeremiah was the word of the Lord (cf. v. 1). Jeremiah received his first instructions from Yahweh as a prophet in the thirteenth year of King Josiah of Judah's reign (640-609 B.C.), namely, 627 B.C. (cf. 25:3).<sup>43</sup>
- 1:3 He also received prophecies from the Lord during the reign of King Jehoiakim (609-598 B.C.) and until the eleventh year of King Zedekiah (597-586 B.C.), namely, 586 B.C., even until the exile of the residents of Jerusalem began in the fifth month of 586 B.C.<sup>44</sup>

"There is particular significance in the reference to the deportation (*galut*) of Jerusalem. This event was the climax to Jeremiah's preaching and a demonstration of his authenticity as a genuine prophet of Yahweh, for in that event the basic thrust of his prophecy was fulfilled."<sup>45</sup>

---

<sup>40</sup>This was a common name in Israel. The Old Testament refers to many different individuals who bore it.

<sup>41</sup>Hilkiyah was also a common name.

<sup>42</sup>The book never refers to him as serving as a priest, and he was often a severe critic of the Levitical priests.

<sup>43</sup>See A Graeme Auld, "Prophets and Prophecy in Jeremiah and Kings," *Zeitschrift für die Alttestamentliche Wissenschaft* 96:1 (1984):66-82, for a study of the history of the terms "prophet" and "prophecy" in the Old Testament.

<sup>44</sup>The writer evidently omitted Jehoahaz and Jehoiachin from this list of kings because their reigns each lasted only three months, in 609 and 598-597 B.C. respectively.

<sup>45</sup>Thompson, p. 141.

We know from elsewhere in the book that Jeremiah also prophesied after the fall of Jerusalem (cf. chs. 40—44). So the dates in this verse fix the period of Jeremiah's main ministry and set it in a historical context.

"We only begin to understand the power of Jeremiah's book if we grasp something of the chaos of his world."<sup>46</sup>

This preface sets the stage for what follows.

## **B. THE CALL OF JEREMIAH 1:4-19**

This account of Jeremiah's call prepares the reader for the prophet's ministry that unfolds beginning in chapter 2. The events recorded here prepared Jeremiah for that ministry, a ministry that frequently discouraged him and made him wish that God had never called him.

### **1. The promise of divine enablement 1:4-10**

1:4 The prophet now began speaking to his readers and telling them what the Lord had said to him. Throughout this book, an indication that the Lord had told Jeremiah something is often the sign of a new pericope, as here (cf. vv. 11, 13; 2:1, 4; 3:6, 11; 4:3, 27; et al.).<sup>47</sup>

1:5 Yahweh knew (Heb. *yada'*, committed Himself to) Jeremiah before He had formed him in his mother's womb (cf. Gen. 4:1; Ps. 1:6; Hos. 4:1; Amos 3:2).<sup>48</sup> He had set him aside (Heb. *hiqdish*) from all other uses for prophetic ministry even before his birth (cf. Isa. 6; Ezek 1—3; Amos 7:10-17). His prophetic ministry would involve many nations (chs. 46—51), not just Judah (chs. 2—45).

"The thought that his very existence was a conscious part of divine purpose and not an incidental biological occurrence must have given him a special sense of destiny. This in turn doubtless contributed to his determination to fulfil [*sic*] his prophetic mission regardless of personal considerations."<sup>49</sup>

"God identified Himself to be sovereign over Jeremiah in that He (1) foreknew Jeremiah before he was born, (2) had caused him to be born, and (3) had separated him for a holy

---

<sup>46</sup>Craigie, p. 5.

<sup>47</sup>These references are not the only indicators of a new section of text, but they usually indicate the beginning or ending of a section when they appear.

<sup>48</sup>Note that Jeremiah existed as a human being during his gestation period (cf. Ps. 139:13).

<sup>49</sup>Harrison, *Jeremiah and . . .*, pp. 50-51.



service. On this basis, He also had the sovereign prerogative to appoint Jeremiah to be a prophet."<sup>50</sup>

- 1:6 When the Lord revealed his calling to him, Jeremiah expressed dismay, first, because he was still a youth and, second, because he had not yet learned how to speak confidently and effectively.

Jeremiah's age at his call is not clear except that he was a youth (Heb. *na'ar*, a word that describes children through young men; cf. Gen. 14:24; 22:3; 34:19; Exod. 2:6; 33:11; 1 Sam. 4:21; Judg. 8:14). Jeremiah was probably about 20 years old.<sup>51</sup>

Jeremiah's response to his call reveals the first of his many similarities to Moses (cf. Exod. 4:1-17). The people to whom they spoke did not believe either prophet, and both men claimed to be inadequate as speakers, to name only two likenesses. Jeremiah's contemporaries could very well have mistaken him for the prophet like Moses that Moses predicted would come after himself (Deut. 18:18).

- 1:7 The Lord refused to accept Jeremiah's reasons for refusing his call. It did not matter that he was young and inexperienced because the Lord had called him. He would go where God sent him and say what God told him to say.

- 1:8 He was not to fear the response of his audience because the Lord promised to be with him and to deliver him from his threatening hearers (cf. Gen. 15:1; Num. 21:34; Deut. 3:2; 31:6, 8; Josh. 1:9; Dan. 10:12, 19; Matt. 28:20; Luke 1:30; 5:10; Acts 27:24). The Lord always supports the servants whom He sends on His missions (cf. Exod. 3:12).

- 1:9 By stretching out His hand and touching Jeremiah's mouth, the Lord symbolized the transfer of His words to the prophet's mouth (cf. Deut. 18:18). He also explained the meaning of His act. This was a powerful way of visualizing that the Lord Himself would participate in all that Jeremiah would undertake (cf. Isa. 6:6-7; Ezek. 3:1-3).

God uses ordinary people to accomplish His extraordinary work if they trust in Him in spite of their fears, obey Him in spite of their inexperience, and proclaim His Word in spite of their feelings of inadequacy.<sup>52</sup>

- 1:10 The Lord appointed Jeremiah to a position of authority over the nations in the sense that he would announce God's will for them. He would announce both good news and bad, oracles of judgment and messages of comfort

<sup>50</sup>Irving L. Jensen, *Jeremiah and Lamentations*, p. 19.

<sup>51</sup>The estimates of the commentators range from about 16 to 25 years old.

<sup>52</sup>Charles H. Dyer, in *The Old Testament Explorer*, p. 591.

and encouragement. The verbs in this verse anticipate the whole message of this book, as one might expect in an introduction.<sup>53</sup> Four of them are destructive and only two are constructive reflecting the predominantly negative emphasis of Jeremiah's ministry. The Lord compared Jeremiah's work to that of two types of workers: a farmer and an architect.

"This is a paradigm of the spiritual life, for God has first to remove the sin before the sinner can begin to grow in grace and in the knowledge of Jesus Christ (*cf.* Eph. 4:15; 2 Pet. 3:18)."<sup>54</sup>

". . . the Bible gives us a realistic message that Jeremiah preached into his own days, a message I am convinced the church today must preach if it is to be any help in the post-Christian world."<sup>55</sup>

"First, we may say that there is a time, and ours is such a time, when a negative message is needed before anything positive can begin. There must first be the message of judgment, the tearing down. There are times, and Jeremiah's day and ours are such times, when we cannot expect a constructive revolution if we begin by overemphasizing the positive message. . . .

Second, with love we must face squarely the fact that our culture really is under the judgment of God. We must not heal the sickness lightly. We must emphasize the reality."<sup>56</sup>

"What we are is God's gift to us; what we do with it is our gift to Him."<sup>57</sup>

## **2. Two confirming visions 1:11-19**

The Lord gave Jeremiah two visions to help him appreciate the nature of his calling, two witnesses to his calling. The first one stresses the ultimate effectiveness of his ministry and the second its negative emphasis. The first deals with the time of judgment and the second with the direction and nature of it.

### **The vision of the almond tree 1:11-12**

1:11           The Lord directed the prophet to observe the branch of an almond tree. The almond tree is distinctive as the first tree to blossom in Israel. Many

<sup>53</sup>See Hobart E. Freeman, *An Introduction to the Old Testament Prophets*, p. 243-44.

<sup>54</sup>Harrison, *Jeremiah and . . .*, p. 50. See also Kenneth L. Barker, "Jeremiah's Ministry and Ours," *Bibliotheca Sacra* 127:507 (July 1970):223-31.

<sup>55</sup>Schaeffer, p. 36.

<sup>56</sup>*Ibid.*, pp. 70, 71.

<sup>57</sup>Warren W. Wiersbe, "Jeremiah," in *The Bible Exposition Commentary/Prophets*, p. 77.

almond trees still grow in Israel, even in the area of old Anathoth, so the tree was probably common to Jeremiah.

1:12 Yahweh explained that He would watch over His word to perform it. The connection with the almond branch is in a word play. "Almond" is *shaqed* in Hebrew, which also means "awake," and "watching" is *shoqed*. The meaning seems to be that just as the blooming of the almond branch announced that spring was near, so the prophet's word would herald the imminence of what he predicted. The NEB translated the last part of the Lord's statement in this verse, "I am early on the watch to carry out my purpose."

"Jeremiah's vision of the 'awake tree' reminded him that God was awake and watching over His word to make sure it came to pass."<sup>58</sup>

These two verses summarize a central theme of Jeremiah: the inevitable fulfillment of Yahweh's announcements concerning Judah and the nations.

### **The vision of the boiling pot 1:13-19**

This vision may have come to Jeremiah immediately after the preceding one or at some other time.

1:13 The Lord next directed Jeremiah to view a boiling pot (cauldron used for cooking or washing, Heb. *sir*) that was tipped so that it was about to pour its contents out to the south. The Hebrew clarifies that a strong wind was blowing thus making the fire under the pot hot and causing it to boil over.

1:14 The Lord explained that the contents of the boiling pot represented an evil that would overflow upon all the inhabitants of Judah from the north. Most of the commentators, and I, believe this refers to Babylon (cf. 25:9; 39), but a few think it refers to the Scythians.<sup>59</sup> The major threat to Judah when Jeremiah began his ministry was Assyria, but Assyria soon declined and Neo-Babylonia took its place. Whereas Babylon (and Assyria) lay to the northeast of Palestine, its invading armies would descend from the north since the Arabian Desert kept them from advancing directly from the east.

1:15 The evil from the north would be many families (peoples) of the kingdoms of the north; it would be a massive invasion. These enemies would invade Judah, besiege Jerusalem, and seek to conquer and rule the land.

1:16 The Lord would use these invaders to judge the Judahites for their wickedness, namely, forsaking the Lord and worshipping other gods and

---

<sup>58</sup>Dyer, "Jeremiah," p. 1131.

<sup>59</sup>See Harrison, *Introduction to . . .*, pp. 803-4; Feinberg, pp. 361-62; or Graybill, p. 657, for further discussion of the foe from the north.

the idols they made with their own hands. These sins demonstrated Judah's covenant unfaithfulness for which God had promised curses (Lev. 26:14-39; Deut. 28:15-68).

- 1:17 Jeremiah was to get to work and announce all of the Lord's messages to His people (cf. Exod. 12:11; 2 Kings 4:29; 9:1; Luke 12:35; Eph. 6:14; 1 Pet. 1:13). He was not to let fear discourage him from being obedient (cf. Deut. 31:6-8; Josh. 1:6-9; Eph. 6:14) because if he did the Lord would really give him something to fear. The disobedient believer not only fears people, but he or she also has God to fear because God becomes his or her adversary (cf. 12:5-6; 20:9).
- 1:18 The Lord promised that none of the people of Judah—the kings, the princes, the priests, or the ordinary citizens—would be able to destroy Jeremiah. He would make Jeremiah as impregnable as a fortress, as irresistible as a fortified city, as strong as an iron pillar, and as resistant to attack as a bronze wall.<sup>60</sup> Jeremiah would not be popular in his day. His greatness was "not his fame, but his faithfulness."<sup>61</sup>
- 1:19 The people of Judah would fight him and try to destroy him, but the Lord promised again to be with Jeremiah and to protect his life (cf. v. 8). The Lord would rescue him, as He had the Israelites in the Exodus (cf. Exod. 3:8; 18:4, 8-1; et al.).

". . . if you are a Christian looking for an easy ministry in a post-Christian culture where Christians are a minority, you are unrealistic in your outlook. It was not to be so in Jeremiah's day, and it *cannot* be so in a day like our own."<sup>62</sup>

"For Jeremiah as for us, his [God's] way in general is not to stop the fight but to stand by the fighter."<sup>63</sup>

"Prophets are almost extinct in the religious world today. The modern church is a 'non-prophet' organization."<sup>64</sup>

"The account of the vocation in Jer 1 has set the stage for reading with understanding the chapters of the book that follow. But now that the stage has been set, the reader must be careful not to forget this account of vocation, for its memory will return to haunt the prophet in later years (and subsequent chapters). The memory will emerge openly in the 'Confessions' that ensue from later trials, but still its shadow is felt in the

---

<sup>60</sup>Thompson, p. 157.

<sup>61</sup>Fred M. Wood, *Fire in My Bones*, p. 24.

<sup>62</sup>Schaeffer, p. 37.

<sup>63</sup>Kidner, p. 28.

<sup>64</sup>Vance Havner, cited in Dennis J. Hester, compiler, *The Vance Havner Quotebook*, p. 179.

last years of the prophet's life as a refugee in Egypt, cut off from the land in which the call came."<sup>65</sup>

Jeremiah's calling was not really that unusual. God has also chosen every Christian before the foundation of the world (Rom. 8:29-30; Eph. 1:4). He has chosen us to follow Him faithfully (1 Cor. 6:20). He has also called every Christian to announce His Word (Matt. 28:19). He has called us to follow Him as He leads us through life by His Spirit (Rom. 8:14; Gal. 5:25). And He has promised to be with us and to preserve us eternally even though we live as aliens and strangers in a hostile world (Matt. 28:20; Rom. 8:31-39).

## **II. PROPHECIES ABOUT JUDAH CHS. 2—45**

The first series of prophetic announcements, reflections, and incidents that comprise this part of the book deals with Jeremiah's ministry to his own people.<sup>66</sup> The second main division of the book contains oracles against foreign nations (chs. 46—51).

### **A. WARNINGS OF JUDGMENT ON JUDAH AND JERUSALEM CHS. 2—25**

Chapters 2—25 contain warnings and appeals to the Judahites in view of their sins and the consequences of those sins.

#### **1. Warnings of coming punishment because of Judah's guilt chs. 2—6**

Most of the material in this section is prophetic oracles that are poetic in form. There are three messages, the first indicting Judah for her evil (ch. 2), the second pleading for repentance (3:1—4:4), and the third declaring divine judgment (4:5—6:30).

". . . it is possible that at an early stage in the development of the book, this collection of prophetic oracles was brought together as a kind of summary of the prophet's early ministry."<sup>67</sup>

"The major themes in these five chapters are (1) God's indignation against moral and social sin, (2) his love for his people and land, (3) the certainty of doom on the unrepentant nation, and (4) salvation for the believing."<sup>68</sup>

#### **Yahweh's indictment of His people for their sins ch. 2**

"The whole chapter has strong reminiscences of a legal form which was well known in the secular world, the so-called *rib* pattern. When lesser kings offended their overlords in some act of rebellion, the overlord sent a

---

<sup>65</sup>Craigie, p. 18.

<sup>66</sup>Though Jeremiah ministered to Judah, he frequently referred to his nation as Israel, as did other of the prophets.

<sup>67</sup>Craigie, p. 19. Compare chapters 1—5 of Isaiah, which serve a similar function.

<sup>68</sup>Feinberg, p. 386.

written message by the hands of a messenger. Several of these documents are extant today. It seems clear that there was a proper legal form in which to lay a charge against a rebel. The shape was as follows: (i) an appeal to the vassal to pay heed, and a summons to the earth and the sky to act as witnesses; (ii) a series of questions each of which carried an implied accusation; (iii) a recollection of past benefits bestowed on the vassal with some statement of the offenses by which he had broken his treaty (covenant); (iv) a reference to the futility of ritual compensations, recourse to foreign cults, or other kinds of aid; (v) a declaration of culpability and a threat of judgment."<sup>69</sup>

Chapter 2 reads like one of these documents in that it contains the basic elements. However, this was not a formal legal document that Yahweh sent to His people but a spoken message through His prophet. The form of the message undoubtedly reminded the original hearers of these *rib* (lawsuit) documents and highlighted the position of the people as Yahweh's unfaithful vassals who had broken His covenant and were, therefore, in trouble with Him.

"This chapter is a powerful sermon dealing with apostasy, and was delivered with all the zeal of an evangelist, as is evident from the power and vitality of the language."<sup>70</sup>

### **Yahweh's remembrance of Israel's past 2:1-3**

- 2:1-2a      The Lord spoke to Jeremiah and instructed him to proclaim a message to the people of Jerusalem, a message from Yahweh.<sup>71</sup>
- 2:2b      The Lord recalled how His people used to love (Heb. *hesed*) Him devotedly when they were following Him through the wilderness from Egypt to the Promised Land.<sup>72</sup> Those were the days of Israel's betrothal as a youth, before she settled down with the Lord in the land (cf. Hos. 1—3).
- 2:3      In those days Israel was set apart to the Lord in a way that she had not been since she entered the land and began to worship idols (cf. Exod. 19:6; 22:31). She was His firstfruits among the nations that He would bless (cf. Gen. 12:1-3; Lev. 23:10, 17; Deut. 25:1-11). The Lord punished peoples who tried to devour the Israelites then as He punished those who ate His firstfruits offerings without divine authorization (Lev. 22:10, 16).

<sup>69</sup>Thompson, pp. 159-60. Mic. 6:1-8 is a fine biblical example.

<sup>70</sup>Harrison, *Jeremiah and . . .*, pp. 53-54.

<sup>71</sup>Other verses that refer to Jeremiah receiving a word from the Lord begin other sections of speeches, namely, 7:1; 11:1; 13:1; and 18:1.

<sup>72</sup>Even though the Israelites were not completely faithful to the Lord in the wilderness, their commitment to Him then was much stronger than it was in Jeremiah's day. Their error then was mainly lack of faith (unbelief) whereas in Jeremiah's day it was departure from Him (apostasy).

### Yahweh's claims to having dealt justly with His people 2:4-8

The general flow of thought in this early part of Jeremiah's message is from Israel's early devotion to Yahweh (vv. 2-3) to her departure from Him (vv. 4-13) to the tragic results of her unfaithfulness (vv. 14-19). In this second pericope the irrationality of Israel's apostasy stands out.

- 2:4            Jeremiah appealed to all the Israelites in his audience to hear what God had to say to them.<sup>73</sup>
- 2:5            The Lord wanted to know what He had done to provoke His people to leave Him and pursue other gods that left them empty.<sup>74</sup>
- 2:6            The Israelites had not even asked themselves where the Lord who had redeemed them in the Exodus and preserved them through the wilderness was. They totally disregarded Him.
- 2:7            The Lord had brought His people into a fruitful land and had given them its produce and wealth, but they had defiled His land with their sins and made it an abomination with their idolatry.
- 2:8            The leaders of the people were no better than the ordinary citizens. The priests, rulers, and (false) prophets all failed to direct the people to Yahweh and, instead, led them away from Him into unprofitable pursuits.<sup>75</sup> The priests should have encouraged the people to be faithful to the covenant and should have kept the sacrificial system pure. The governmental rulers (lit. shepherds) should have directed the people to the Lord rather than away from Him. And many professing prophets, instead of bringing messages from the Lord, brought alleged directions from Baal and followed vain pursuits.

"The reference to Baal here and elsewhere in the prophecy is to idols in general."<sup>76</sup>

"Surely this has something to do with the message we must speak to our post-Christian world. We must treat men with love, we must treat them and talk to them humanly. But we

<sup>73</sup>Some scholars believe that attention-getting devices such as this one, and other clues in the text, indicate the beginning of a new oracle. Craigie, pp. 20-21, for example, found evidence of six separate oracles in chapter 2. These students of the sources of our present canonical text believe that Jeremiah, or some other editor, arranged a number of shorter oracles into the sermon we have in chapter 2 for literary purposes. This is possible, I think, but not absolutely certain.

<sup>74</sup>The Hebrew word *hahebel*, translated "emptiness," may be a word play on the name Baal.

<sup>75</sup>Harrison, *Jeremiah and . . .*, pp. 56-57, suggested that another word play on the name Baal may be *lo' yo'ilu*, translated "things that did not profit." A similar phrase, *belo yo'il*, occurs at the end of verse 11 and is translated "that which does not profit."

<sup>76</sup>Feinberg, p. 389.

must not tone down our message: the religious leaders of our day too are leading people astray."<sup>77</sup>

### **Yahweh's promise to contend with His people 2:9-13**

2:9 Because of their unparalleled idolatry, the Lord promised to contest His people. Even their grandchildren would experience His discipline because of their forefathers' sins.

". . . Scripture often stresses the solidarity of one generation with another, endorsing our sense of pride or shame over our collective past."<sup>78</sup>

2:10-11 The Lord challenged His people to look to other nations to see if any of them had done what they had done. None of their neighbor nations had ever forsaken gods whom they thought had blessed them in the past. This was true of them all, from Kittim (Cyprus), to Israel's northwest, to Kedar (in the Arabian Desert), to the southeast (cf. Gen. 10:4; 25:13). Yet the Israelites had forsaken the only true God, who had made them a glorious people, for gods that did not give them anything.

2:12 Yahweh called the heavens as witnesses to Israel's folly (cf. Deut. 32:1; Isa. 1:2; Mic. 6:1; et al.). They could only be appalled and shudder at such foolishness and feel desolate over such apostasy.

2:13 The Israelites had committed two evils, one a sin of omission and the other a sin of commission. They had forsaken Yahweh who, like a fountain, had provided for their deepest needs (cf. Ps. 36:9; John 4:10-14; Rev. 21:6). And they had pursued idols who, like broken cisterns, could not even hold water much less provide it. The most reliable source of water in Israel was a natural spring, and the least reliable was a cistern.

"The best cisterns, even those in solid rock, are strangely liable to crack, and are a most unreliable source of supply of that absolutely indispensable article, water; and if, by constant care, they are made to hold, yet the water, collected from clay roofs or from marly soil, has the color of weak soapsuds, the taste of the earth or the stable, is full of worms, and in the hour of greatest need it utterly fails. Who but a fool positive, or one gone mad in love of filth, would exchange the sweet, wholesome stream of a living fountain for such an uncertain compound of nastiness and vermin!"<sup>79</sup>

---

<sup>77</sup>Schaeffer, p. 53.

<sup>78</sup>Kidner, p. 34.

<sup>79</sup>W. H. Thomson, *The Land and the Book*, 1:443.



### Israel's perverse conduct 2:14-19

Perverse conduct was the consequence of Israel's apostasy and infidelity, and it led to slavery.

2:14-15 Israel was Yahweh's firstborn son, not a slave or even a home-born servant.<sup>80</sup> As such he enjoyed the special care and provisions of the Lord. Then why had he become a prey to enemies? Enemy rulers, like young lions, had threatened and devoured Israel's land and destroyed his cities.<sup>81</sup> The Northern Kingdom had gone into captivity in 722 B.C. After that captivity lions multiplied in the land and became a threat to the people who lived there (cf. 2 Kings 17:25). The Assyrians attacked the Israelites like voracious lions many times.

"Israel, in the metaphor, had not only become a slave, but after a generation or more had become a household servant, one for whom even the memory of freedom had been lost. But the statement of Israel's slavery in the form of two questions implies that slavery should never have come to pass. Israel, in its covenant, had been granted freedom."<sup>82</sup>

2:16 The Egyptians had cropped Israel's glory. In the ancient world long hair was a glorious thing. Perhaps Pharaoh Shishak's invasion of Judah in 925 B.C. is in view here (1 Kings 14:25-26). A more likely possibility is the slaying of King Josiah at Megiddo, when Pharaoh Neco took the crown (king) from the nation's head in 609 B.C. (2 Kings 23:29). In both instances Egypt had shorn Israel.

Memphis (Noph) was the ancient capital of Lower (Northern) Egypt, about 13 miles south of modern Cairo. Tahpanhes (Daphne) stood near Lake Manzaleh in northeastern Egypt. It was the first significant Egyptian town that travelers came to on a land journey from Judah to Egypt. It was about 150 miles across the desert from Gaza. Later, Jeremiah and other Hebrew refugees settled there (43:7-9).

2:17 Now the answer to the question posed in verse 14 comes. The Israelites had brought these calamities on themselves by forsaking Yahweh their God who had led them so competently in the earlier years of their history.

2:18 God's people had turned to Egypt and Assyria for refreshment instead of to Him (cf. Isa. 30:1-5). In Jeremiah's day there was a pro-Egyptian party

---

<sup>80</sup>People paid to purchase slaves for a period of service in Israel, but home-born servants belonged to their masters as personal possessions (Exod. 21:1-6). See *The New Bible Dictionary*, 1962 ed., s.v. "Slave, Slavery," by Kenneth A. Kitchen, pp. 1195-98.

<sup>81</sup>The lion was a symbol of both Assyria and Babylonia.

<sup>82</sup>Craigie, p. 32.

and another pro-Assyrian party.<sup>83</sup> The designation of the Nile River as the *shihor* (lit. blackness) may have been a way of denigrating the river, which was one of Egypt's primary gods. The Nile was muddy and, so, black.

This reference to the Judahites seeking help from Egypt and Assyria probably dates this sermon sometime before the decline of Assyrian supremacy in the ancient Near East, namely, before 612 B.C., when Nineveh fell (cf. 2 Kings 15:19; 16:7; 17:3; Hos. 5:13; 7:11; 8:9).

2:19 The consequences of the people's own wickedness and apostasies would come back on them and plague them. This should teach them that it was morally evil and experientially bitter for them to abandon Yahweh their God. All these bad things happened to them because they did not fear the Lord.

"The greatest judgment God can send to disobedient people is to let them have their own way and reap the sad, painful consequences of their sins."<sup>84</sup>

"One may turn to or away from Yahweh, and one may turn to and away from other allegiances. No book in the OT contains so many nuances of this idea as Jeremiah."<sup>85</sup>

### Evidences of Israel's ingratitude 2:20-25

Baal worship fascinated the Israelites, but it was futile.

2:20 The Lord had broken the yoke of Egypt off His people at the Exodus and had set them free, but being ungrateful they refused to yield themselves to Him in covenant faithfulness.<sup>86</sup> Rather they had prostituted themselves to the gods of Canaan worshipping idols at their hilltop and grove shrines.

". . . the 'sexual revolution' introduced in the 1960s is not only permissive: it has its own propaganda to create a view of sex as virtually life's chief concern and most authoritative voice—certainly one that can override the voice of God."<sup>87</sup>

2:21 Yahweh had planted Israel in the Promised Land as a choice vine,<sup>88</sup> as His faithful seed, but Israel had grown up as a degenerate vine that bore the marks of foreign stock (cf. Isa. 5:1-7; Ezek. 15; Matt. 21:33-46).

<sup>83</sup>Feinberg, p. 392; Graybill, p. 661.

<sup>84</sup>Wiersbe, p. 80. Cf. Rom. 1:24.

<sup>85</sup>Thompson, p. 175.

<sup>86</sup>The Septuagint and Vulgate translations have "you" instead of "I broke your yoke." The translators interpreted this verse to mean that Israel had long ago thrown off all restraint. But the Hebrew text is probably correct here.

<sup>87</sup>Kidner, p. 33.

<sup>88</sup>This is literally a *sorek* vine, a vine that thrived between Jerusalem and the Mediterranean Sea, especially in the Sorek Valley, and bore high-quality red grapes.

- 2:22 Israel could not cleanse herself of her iniquity. Ritual ablutions and sacrifices would not do the job (cf. 1 John 1:7). Lye was a mineral alkali cleanser, and soap was a vegetable alkali cleanser.
- 2:23 Neither could Israel deny that she had gone after Canaanite idols, though the people tried to. The Judahites worshipped Baal and Molech in the Hinnom Valley just south of Jerusalem (cf. 7:31-32; 2 Kings 23:10). All Judah had to do was examine her experiences and she would see that she was all tangled up, like a young camel that got wrapped up in its ropes for thrashing around where it did not belong.
- 2:24 Israel was also like a wild donkey that followed the scent that appealed to it rather than following its master. Like a wild female donkey in heat, Israel had done things that were unnatural (cf. Gen. 16:12; Job 11:12). Enemies pursued Israel and found her, just like male donkeys find female donkeys that are in heat.

"She [the female donkey] sniffs the path in front of her trying to pick up the scent of a male (from his urine). Then she races down the road in search of the male. One Arab proverb runs, 'She is intoxicated with the urine of the male.' Under such circumstances the males need not weary themselves chasing the she-ass, because she is bent on chasing them."<sup>89</sup>

The people had worn out their sandals and fainted from thirst in their pursuit of idols.

- 2:25 Israel should guard herself from living like a wild animal and therefore suffering from thirst. But Israel had said that it was hopeless to live like a domesticated animal. Like an alcoholic or drug addict she believed it was impossible for her to submit to and serve her Master faithfully. She had let her heart go after strangers and had decided to follow them instead of Yahweh.

### **Israel's shame because of her apostasy 2:26-28**

- 2:26 Yahweh had uncovered Israel's sins and had shamed her, as when someone exposes a thief. All her leaders were objects of shame because they led the people in apostasy (cf. v. 8).
- 2:27 The leaders had advocated worshipping the creation rather than the Creator and had promoted the worship of Asherah poles and stone pillars.

---

<sup>89</sup>Thompson, p. 179. The camel illustrates unreliability and the donkey lust-based passion in this instance. See K. E. Bailey and W. L. Holladay, "The 'Young Camel' and 'Wild Ass' in Jer. 2:23-25," *Vetus Testamentum* 18 (1968):256-60.

These were phallic symbols in Canaanite religion that represented the powers of creativity and fertility.<sup>90</sup> Instead of looking to the Lord, they had turned their backs on Him. Still, when trouble came, they would cry out to Yahweh to save them.

- 2:28 Let your idols save you then, the Lord responded. Obviously they could not save themselves since the people made the gods; the gods had not made the people and so could not help them. Wood and stone cannot arise to save, and neither can the idols made from these materials. The number of idols in Judah in Jeremiah's day was the same as the number of her cities. This is a hyperbolic way of saying that idolatry was rampant throughout the land.

### **Israel's hardness of heart 2:29-37**

Israel deserved judgment, and this pericope shows why. Jeremiah presented a series of pictures of the nation's irresponsibility and corruption.

- 2:29 The Lord wanted to know why His people were angry with Him. The difficulties they were experiencing were the result of their transgressions of His law.
- 2:30 But the Lord's discipline had not produced repentance (cf. Matt. 23:37; Luke 13:34; Acts 7:52). Even the younger generation refused to learn from their chastening. If this oracle dates from the time of Josiah, as seems probable, the younger generation, of which Jeremiah was a part, would have seen the fruit of King Manasseh's apostasy and should have turned from it.

"In the secular realm when a great king visited an erring vassal with some kind of punishment the vassal would come to heel, at least in the normal case. But in the case of Israel the divine visitation in some form of judgment was in vain. The people would not accept correction. Rather, they turned on Yahweh's representatives and spokesmen the prophets and destroyed them [cf. 26:20-23; 2 Kings 21:16; Neh. 9:26]."<sup>91</sup>

- 2:31 The Lord called all the people alive in Judah then to pay attention and give heed to His word to them (cf. Matt. 3:7; 12:43; 23:33; Luke 3:7). He had not been as ungiving as a wilderness or as benighting as darkness to them. They had no reason to feel free to abandon Him.

---

<sup>90</sup>Craigie, p. 39.

<sup>91</sup>Thompson, pp. 182-83.

- 2:32 Young girls rarely forget their first jewelry, and brides hardly ever forget what their wedding dress (lit. sash) looked like. But God's people had forgotten their greatest treasure and their glory long ago (cf. Deut. 8:11, 19; 32:18; Ps. 78:11; 106:13, 21; Isa. 17:10).
- 2:33 Ironically, like an unfaithful wife Israel had prepared herself to seek a new lover. Her behavior had given ideas of unfaithfulness to other nations that did not even know the Lord. As a prostitute, Israel could teach even the heathen harlots a few tricks.
- ". . . it was true then as now, that the pagan has nothing to teach the hardened apostate, nor the outright unbeliever the religious double-thinker."<sup>92</sup>
- 2:34a In her unfaithfulness, Israel had gone so far as putting innocent people to death (cf. 26:20-23; 1 Kings 21:16; Neh. 9:26). If these people had done something worthy of death, such as breaking into a house, such bloodshed would have been tolerable (cf. Exod. 22:2-3)
- "Wicked behaviour always involves innocent people to some extent, as Christ demonstrated in bearing the sins of humanity (cf. 1 Pet. 2:20-24)."<sup>93</sup>
- 2:34b-35 In spite of all this guilt, Israel still claimed to be innocent and hoped that Yahweh's anger against her would subside. But the Lord promised to bring her to judgment because she falsely claimed to be not guilty.
- 2:36 Israel was wrong to change her ways, from following the Lord faithfully to pursuing idols, so often. The Lord would bring the hopes of the pro-Egyptian party to nothing. He had already used Assyria, which other Judeans trusted in, to overrun and take captive the Northern Kingdom (in 722 B.C.).
- 2:37 From Jerusalem (cf. v. 2) God's people would depart in grief and captivity, with their hands on their heads, because Yahweh had rejected the nations in whom Israel trusted and by whom she hoped to prosper (cf. 2 Sam. 13:19). He wanted them to trust and prosper in Him.

Throughout this oracle Jeremiah presented Israel's covenant unfaithfulness to God from two perspectives: religious and political. Yahweh's people had abandoned exclusive faith in their covenant God and had committed spiritual adultery by participating in the Baal fertility cult. Nationally they had ceased to recognize Yahweh's sovereignty over them and had turned to Egypt and Assyria for security.<sup>94</sup>

---

<sup>92</sup>Kidner, p. 34.

<sup>93</sup>Harrison, *Jeremiah and . . .*, p. 62.

<sup>94</sup>Craigie, p. 45.

### **Yahweh's call for His people's repentance 3:1—4:4**

A passionate plea for repentance follows logically and textually the indictment of God's people for their sins (ch. 2).

"There is a problem with free forgiveness. If you can always wipe the slate clean, how much does it matter what you write on it next? It is a problem for both parties—not only for the one in the wrong, who may feel that he can get away with more and more, but also for the one who forgives, who has to wonder what his forbearance may be doing to the other person. Here God sets about shaking his people out of their complacency."<sup>95</sup>

### **The spiritual unfaithfulness of Judah 3:1-5**

3:1 God posed the question to His people of what happens in a divorce. The answer to His rhetorical question is, no, a husband who divorces his wife, if she goes to live with another man, will not return to her.<sup>96</sup> The Mosaic Law forbade such a thing (cf. Deut. 24:1-4). If Judah was a wife and Yahweh was her husband, He would not normally "return" to her.<sup>97</sup> The Israelites believed that sin and evil in the people had repercussions on the land and polluted it (cf. vv. 2, 9; Lev. 18:25, 28; 19:29; Deut. 24:4; Hos. 4:2-3; Amos 4:6-10).

A second figure compares Israel to a harlot with many lovers. She was worse than a divorced wife. Would such a woman expect her husband to receive her back if she returned to him? No. The people of Judah had no reasonable expectation that Yahweh would receive her back even if she repented (cf. Hos. 2:14—3:3).<sup>98</sup>

3:2 Continuing the figure of Judah as a harlot, the Lord urged His people to look around. There was hardly a place they could see where they had not been unfaithful to Him by worshipping idols. They had pursued this evil as avidly as roadside harlots sought lovers (cf. Gen. 38:14-23; Prov. 7:12-15; Ezek. 16:25). Arabs of the desert waited along the wilderness routes and eagerly offered wares for sale to anyone who passed by. They also sometimes hid in ambush to rob passing caravans. The similarly eager Israelites had polluted the land spiritually with their wicked harlotry.

---

<sup>95</sup>Kidner, p. 35.

<sup>96</sup>The Septuagint has the question being will the woman return to her first husband, but there is inferior support for this translation.

<sup>97</sup>"Return" is a key word in this sermon, as it is in the whole book. There are three specific commands to return in this section (vv. 12, 14, 22) as well as numerous other occurrences of the word and its relatives. "Return," for example, appears nine times in the NASB (3:1, 7 [twice], 10, 12, 14, 22, 4:1 [twice]) and "turn" twice (3:1, 19).

<sup>98</sup>See Joe M. Sprinkle, "Old Testament Perspectives on Divorce and Remarriage," *Journal of the Evangelical Theological Society* 40:4 (December 1997):542-43.

3:3 Consequently the Lord had withheld rain from the land, as He threatened to do if His people departed from Him (Lev. 26:19; Deut. 28:23-24). In the spring, when the people needed rain so their crops would mature, the heavens were dry. In spite of this punishment they refused to repent. They did not feel shame for their apostasy but behaved brazenly. To have a harlot's forehead was to be brazen-faced.<sup>99</sup>

"God's withholding of the rains should have indicated clearly enough to the people that their fertility rites ensured nothing; the God of covenant was as much Lord of the natural world as he was of the events of history."<sup>100</sup>

3:4 Instead of repenting, they besought God to help them, calling Him their Father, the friend who had guided them in their youth.

3:5 They also asked Him if He would always be angry with them. They acknowledged that He had spoken warnings in the past and had followed up His words with acts of judgment. He had had His way with them, but now, they implied, it was time for Him to relent. They failed to appreciate that the end of His punishment required repentance from them, not a change of heart from Him.

"Persistent, habitual sin can desensitize an individual to the nagging of one's conscience, the convicting work of God's Spirit, or the direct rebuke of God's Word."<sup>101</sup>

### **The persistent harlotry of Israel and Judah 3:6-10**

3:6 Yahweh previously had a conversation with Jeremiah along the same lines that took place during the reign of King Josiah (between 627 and 609 B.C.).<sup>102</sup> The Lord asked the prophet if he had observed that the Northern Kingdom of Israel had been guilty of flagrant spiritual prostitution. He described the Northern Kingdom as "faithless Israel," literally "apostasy (Heb. *meshuba*) Israel" (cf. vv. 8, 11, 12). Israel was apostasy personified. She was faithless in respect to the Mosaic Covenant and in respect to her relationship to Yahweh as His "wife." She had deserted her covenant with the Lord and made a covenant with Baal, and she had failed to maintain her responsibilities as Yahweh's "wife."

3:7 The Lord had expected that eventually Israel would have returned to Him, but she had not.<sup>103</sup> Furthermore, the Southern Kingdom of Judah, Israel's

<sup>99</sup>Graybill, p. 662.

<sup>100</sup>Craigie, p. 52.

<sup>101</sup>Dyer, in *The Old . . .*, p. 594.

<sup>102</sup>This section may have been one of those shorter oracles that the writer used to compose the final written sermon.

<sup>103</sup>Obviously Israel's actions did not surprise God since He knows everything before it happens. This is an anthropomorphic way of describing God's chagrin at Israel's behavior.

treacherous sister, observed Israel's unrepentant harlotry. As Israel was apostasy personified, so Judah was treachery personified (cf. vv. 10, 11, 20).

- 3:8 Yahweh decided to put away His unfaithful "wife" Israel, to divorce her. So He sent her off to Assyria in captivity. But observing the consequences of Israel's conduct did not discourage Judah from following in her sister's footsteps. She too became a spiritual harlot and betrayed the trust of her "husband."<sup>104</sup>
- 3:9 Israel took her prostitution very lightly and committed spiritual fornication with the pagan idols of Canaan, which stone pillars and tree groves and poles represented (cf. 2:27).<sup>105</sup>
- 3:10 Still Judah did not return to the Lord with heartfelt repentance but only superficially. Jeremiah began ministering (in 627 B.C.) one year after King Josiah began his spiritual reforms (in 628 B.C.). This oracle may have come early in Jeremiah's ministry before the reforms had taken hold. But the rapidity with which Judah declined following Josiah's death seems to indicate that the reforms produced only a superficial return to the Lord. King Manasseh's long godless reign (697-642 B.C.) was more than Josiah's comparatively brief reforms (628-609 B.C.) could counteract. Though Josiah led the nation in a reformation, the people did not experience a heart-changing revival.

### **The future repentance and return of all Israel 3:11-18**

- 3:11 Yahweh instructed His prophet that though both the Northern and Southern Kingdoms had committed spiritual harlotry, Judah's sin was worse than Israel's. Here the Lord personified Judah as "Treachery" as he again personified Israel as "Apostasy" (cf. vv. 6, 12). Israel had been unfaithful, but Judah had been unfaithful and had presumed on the Lord's mercy. Israel had not had the benefit of an example of unfaithfulness to warn her, but Judah did.
- 3:12 Jeremiah was to preach to the remnant left in the Northern Kingdom and to the exiles from that nation that they should repent and return to the Lord (cf. 31:2-6, 15-22). Those who had turned away from the Lord should turn back to Him.<sup>106</sup> He would not hold His anger against them forever but would be gracious to them, if they would genuinely repent.

<sup>104</sup>Yahweh's relationship to both Israel and Judah was the same in that both kingdoms were His chosen people. We should not press the illustration too far or we come out with a picture of God as a bigamist.

<sup>105</sup>For a fuller discussion of these cult objects, see G. E. Wright, "The Archaeology of Palestine," in *The Bible and the Ancient Near East*, pp. 73-112.

<sup>106</sup>This is a play on derivatives of the Hebrew root *shub*, "turn," many of which occur in this sermon.



3:13 Genuine repentance would have to include realizing and acknowledging that what they had done was iniquity, transgression of covenant commands, apostasy and spiritual adultery, and disobedience to Yahweh's Word (cf. Deut. 28:1-2, 15).

"True confession, unfortunately, is a harrowing and humiliating experience, and thus seldom encountered, whether in individuals or nations. The catharsis of confession undoubtedly helps to make Christian forgiveness so rich an experience for the penitent spirit (1 Jn. 1:9)."<sup>107</sup>

3:14 Changing the figure, the Lord invited the prodigal Israelites to return to their Father (v. 4). He would take them back and be their master (Heb. *Ba'al*) again.<sup>108</sup> He, the sovereign Lord of the covenant, was their master, not Baal (lit. "master").

". . . 'I am your *ba'al* (husband)' implies that no longer would Judah be bound to the Baals of the fertility faith to which she had so easily fallen away from the true covenant faith."<sup>109</sup>

The Israelites did not have to come *en mass*. The Lord would receive any individual Israelites who really repented even though they were part of a larger group that did not repent. The Lord would even bring them back to Himself in Zion, the place where He had promised to meet with His people. Thus the way was open for a remnant of spiritually sensitive Israelites to respond.

3:15 After their return, the Lord would give the truly repentant Israelites good leaders who had hearts for Himself and who would instruct them in sound knowledge (wisely) and understanding (well). Kind-hearted shepherds would provide wholesome and nourishing food for their sheep (cf. 23:1-4; Ezek. 34:23; 37:24).

3:16 When many Israelites had repented and returned to the land, they would not take pride in the ark of the covenant. The ark would not even come into their minds, they would not even remember it, they would not miss it, nor would they attempt to rebuild it.<sup>110</sup>

---

<sup>107</sup>Harrison, *Jeremiah and . . .*, p. 66.

<sup>108</sup>Perhaps this promise is the reason the prodigal son in Jesus' parable asked to come back home as a servant rather than as a son (cf. Luke 15:11-32).

<sup>109</sup>Craigie, p. 60. *Ba'al* sometimes has the connotation of "husband."

<sup>110</sup>Most scholars assume that the Babylonians took the ark into captivity when they destroyed the temple in 586 B.C. There is no historical record of it following that event. It is possible, of course, that the Jews may have hidden it sometime before the razing of the temple.

"Verse 16b shows that the old economy was to be dissolved. The old covenant, of which the ark was a central feature, was to give way to another—a preview of 31:31-34."<sup>111</sup>

At this point in the oracle it becomes clear that at least some in Israel definitely would repent and experience divine restoration sometime in the future. Note the recurrence of "in those days" and "at that time" (vv. 16-18). We believe that the repentance in view will take place at the second coming of Christ, when the Jews realize that Jesus is their Messiah. They will then put their trust in Him (Zech. 12:10; 13:1; cf. Rom. 11:26). Much that follows in this oracle concerning the blessings of Israel's repentance describes millennial conditions.<sup>112</sup>

3:17 The reason for these Israelites' lack of interest in the ark would be that in that day the Lord Himself would be enthroned in Jerusalem. The whole city would be known as the place of His throne, not just the ark (cf. Lev. 16:2, 13; 2 Kings 19:15; Ps. 80:1; Ezek. 48:35).

"There is unquestionably a Messianic expectation here (*cf.* Je. 5:18; 31:1; 33:16; Ho. 3:5, *etc.*)."<sup>113</sup>

People from the Gentile nations would also come to Jerusalem, as God would draw them, because of the reputation of Yahweh (cf. Isa. 2:2-3; 56:6-8; 60:11-14; Mic. 4:1-2). Their hearts would be different then, and they would comply with God's will rather than stubbornly resist it.

3:18 Jews from both Israel and Judah would return to the Promised Land from their various places of captivity "in those days" (cf. Hos. 3:5; Mic. 2:12). The Israelites had gone off to the north to Assyria, and the Judahites would go off to the north to Babylon, and they would return from that direction.<sup>114</sup> The north represents wherever the Israelites had gone following the Lord's disbursal of them.<sup>115</sup>

"Since there is no indication that the ten tribes ever repented, the projected union must point to the Messianic age of grace, when Jew and Gentile alike will do honour before the enthroned Lord in Zion."<sup>116</sup>

---

<sup>111</sup>Feinberg, p. 402.

<sup>112</sup>See Walter C. Kaiser Jr., "Evidence from Jeremiah," in *A Case for Premillennialism: A New Consensus*, pp. 105-7.

<sup>113</sup>Harrison, *Jeremiah and . . .*, p. 66.

<sup>114</sup>The ten tribes of Israel are not and never were lost but scattered, awaiting their repentance and regathering in faith to the land.

<sup>115</sup>Some of them, of course, returned to the Promised Land at the end of the Exile, but Titus scattered the Jews again in all directions when he destroyed Jerusalem in A.D. 70.

<sup>116</sup>Harrison, *Jeremiah and . . .*, p. 67. Cf. Zech. 14:16-19.

### The promise of a beautiful land in spite of former treachery 3:19-20

- 3:19 The Lord next explained how He longed for the day when this repentance and return would happen. He would set His chosen people among His other sons (including good angels, Gentile believers, and Christians). He would give them a pleasant land, a more beautiful inheritance than He will give believing Gentiles in the future. Israel and Judah would return to the Lord as their Father and would not turn away from Him any more (cf. Hos. 11:1).
- 3:20 All this blessing would come to Israel in spite of her past treacherous unfaithfulness to her spiritual lover, Yahweh. That treachery was deliberate; it was not a provoked departure.

"The mixing of metaphors (God is both father and husband) heightens the pathos of the speech and helps one empathize with God in his disappointment and emotional pain."<sup>117</sup>

"It is important to retain memory of this deep compassion when we read the prophet's declarations of judgment (4:5ff.); in judgment, the compassion is still present, hoping beyond the judgment for a restoration of the relationship of love."<sup>118</sup>

### The anticipation of Israel's repentance 3:21-25

- 3:21 The Lord could hear, in the future, the Israelites weeping and praying in repentance on the hilltops, where they had formerly committed spiritual adultery (v. 2). They would finally realize that they had perverted their way and had forgotten Yahweh.
- 3:22 This anticipation drew from Him an invitation to His faithless people to return to Him immediately. He promised to heal their faithless addiction to wandering from Him. He also anticipated Israel's response of acceptance. Israel would return and acknowledge again Yahweh as her God.

"This simple statement was crucial, for the root of past errors lay in their failure to recognize the Lord as their one and true God, and their consequent resort to the false gods of the fertility cults. Having declared their recognition of God, they would immediately pass on to a denunciation of the false gods to whom they had resorted."<sup>119</sup>

---

<sup>117</sup>Robert B. Chisholm Jr., *Handbook on the Prophets*, p. 159. See also Terence Fretheim, *The Suffering of God*, p. 116.

<sup>118</sup>Craigie, p. 64.

<sup>119</sup>Ibid., p. 65.

3:23 The Israelites confessed that the hills and mountains on which they had worshipped idols had been sites of deception for them and places of unrest. The idols had not provided what they promised, and instead of finding rest by worshipping them the Israelites had experienced turmoil. They finally acknowledged that only in Yahweh their God could they find true salvation (cf. Exod. 20:2-6; Deut. 5:6-10; 6:4).

3:24 Idolatry had consumed the Israelites in all that they had done throughout their history. It had been a blight on their existence, a shame to them as a people. But another nuance may also have been intended.

". . . Baal is referred to under the substitute name *bosheth*, 'shame' [cf. 11:13; 2 Sam. 2:8: Ish-bosheth, lit. man of shame]. . . 'Shame' (Baal) had devoured all that the labors of their fathers had produced since the people were children."<sup>120</sup>

3:25 They now did not try to run from their shame (cf. Gen. 3:7, 10). Rather they willingly let it cover them and confessed their sin against Yahweh their God, sin that had existed throughout their history as a nation. They had disobeyed the Lord's voice; they had broken His covenant (cf. v. 13).

#### **Gentile blessing through Israelite repentance 4:1-4**

These verses provide the answer to God's question in 3:1. This is the repentance that was necessary for Yahweh to return to His "wife."

4:1a The Lord clarified that for His people to return to a blessed condition they must return to Himself.

4:1b-2 If they would put away their idolatry consistently and would swear by Him, rather than by the idols, then Israel would become responsible for the nations blessing themselves (cf. Gen. 12:3; 18:18; 22:18; 26:4; Isa. 2:3; 65:16). That is, the Gentile nations would come to the Lord and so experience His blessing and would glorify Him.

". . . they will discern in the example of Israel that the source of true blessing lies in Yahweh and that he dispenses his blessings to those who are obedient to his covenant . . ."<sup>121</sup>

Swearing by the Lord means acknowledging Him as master in contrast to lord Baal (lit. master) and other lords.

---

<sup>120</sup>Thompson, p. 209.

<sup>121</sup>Ibid., p. 213.

4:3 This message closes with a call from the Lord to each of Jeremiah's original Jerusalemite and Judean hearers. Yahweh called on them with two agricultural metaphors. They needed to plow up the previously unplowed soil that symbolized their hearts (cf. Hos. 10:12; Mark 4:1-9). They needed to cultivate soft hearts that would welcome the Lord's words. Negatively they needed to stop investing in counterproductive ventures such as idolatry.

"Just as a farmer does not sow his seed on unplowed ground, so God does not sow His blessings in unrepentant hearts."<sup>122</sup>

4:4 Changing the figure, they should make a radical and permanent change in their commitments, a change that sprang from their innermost being (cf. 9:25-26; Deut. 10:16; 30:6; Rom. 2:28-29). Unless they did this they could count on God's judgment that would burn and consume them like unquenchable fire because their deeds were so evil. Breaking the covenant carried very serious consequences.

By repenting as the Lord and His prophet urged, Judah could have experienced a postponement of divine judgment. But Isaiah, over a century earlier, had announced that the Southern Kingdom would fall to Babylon sometime in the future.

This sermon clarifies that the essence of repentance is turning.

". . . the key to life is to be found in the direction in which one faces; if that direction is wrong, one must turn to seek the true direction and walk in that path of life."<sup>123</sup>

### **Yahweh's declaration of divine judgment 4:5—6:30**

The Judahites having sinned greatly (ch. 2) failed to repent (3:1—4:4). Consequently judgment in the form of military invasion would overtake them. This whole section is an amplification and explanation of the overflowing caldron vision in 1:13-16.

This section provides a clear example of the mosaic structure of the Book of Jeremiah. It consists of 13 separate messages that all deal with the threat of approaching invasion from the north. Someone, Jeremiah and or others, skillfully arranged them in the present order to make a strong impact on the reader.

### **The sounding of the alarm that invasion was coming 4:5-10**

4:5 The Lord instructed Jeremiah to call for the people of Judah to assemble in the main cities. Blowing the trumpet in Israel's history and in the ancient

---

<sup>122</sup>Dyer, in *The Old . . .*, p. 595.

<sup>123</sup>Craigie, p. 68.

Near East was a call to assemble and take cover in fortified cities, similar to the sounding of an air raid siren today (cf. Hos. 5:8; Joel 2:1; Amos 3:6).

- 4:6 The people were to lift up a flag or light a signal fire (Heb. *nes*) in Jerusalem as a sign of coming attack (cf. Isa. 13:2; 18:3). They should seek refuge quickly because the Lord was bringing an evil destroying force against them from the north (cf. 2 Kings. 16:5-6; Hos. 5:8; Joel 2:1; Amos 3:6). This was not just a twist of political fate; Yahweh was sending this enemy against His people.
- 4:7 A lion-like enemy had left its home to desolate Judah and its cities, and this enemy would succeed in driving out the inhabitants of these towns (cf. 1 Pet. 5:8). As noted previously, one of the symbols of Babylon was the lion.<sup>124</sup>
- 4:8 The people of Judah were to go into mourning over this situation. They were to view it as part of the continuing judgment of Yahweh on them.
- 4:9 When this enemy invaded, all the people, represented by their various groups of leaders, would be terrified (cf. 2:8, 26). False prophets had created the illusion that peace would continue indefinitely (cf. 6:13-14; 14:13-14; 23:16-17).
- 4:10 Jeremiah responded to this revelation by objecting that the sovereign Lord had misled His people by telling them that they would have peace when really they would have war. The basis of his charge seems to be that God had allowed false prophets to predict peace.<sup>125</sup> Even though Jeremiah announced this judgment he took no personal delight in it because it meant the destruction of his own people.

"At first glance Jeremiah's comments appear to be blasphemous. . . . Rather must we see in such an utterance not so much a considered judgment, but the spontaneous reaction of a man who felt deeply about the tragedies of life, whether his own or those of others."<sup>126</sup>

### **The intensity and severity of the coming judgment 4:11-18**

- 4:11-12 The Lord also said that when this invasion would come it would descend like a violent wind from the north. It would be far more severe than an

<sup>124</sup>See Harrison, *Jeremiah and . . .*, p. 70. See the discussions of the foe from the north in Thompson, pp. 86-87; Kidner, pp. 38-39; or Feinberg, p. 406.

<sup>125</sup>See Chisholm, *Handbook on . . .*, p. 161; idem, "Does God Deceive?" *Bibliotheca Sacra* 155:617 (January-March 1998):18-19; and Robert P. Carroll, *Jeremiah*, pp. 161-62.

<sup>126</sup>Thompson, p. 222.

ordinary attack that the prophet compared to a gentle breeze that would winnow the grain of the people, namely, discipline them gently. This "wind" would come at Yahweh's command and would be the instrument of God's judgment on the people. They were all too familiar with such devastating winds, or siroccos, that blew almost unbearable heat and dust into Judah from the Arabian Desert (cf. Gen. 41:6; Jon. 4:8).

4:13 Jeremiah reflected on the great power of God to bring judgment. He has the power to bring judgment as He has power to build clouds that bring rain. The approaching enemy was like a bank of storm clouds growing in the north (cf. Ezek. 38:16). The coming whirlwind was like a chariot on which the Lord rode to fight (cf. Isa. 5:28; 66:15). He can act even faster than eagles can fly. The foe would swoop down suddenly (cf. Hab. 1:8). Consequently, Judah was in big trouble.

4:14 The prophet appealed to his people to cleanse their hearts so God would be merciful to them. There was still time for repentance. The people needed to get rid of their wicked thoughts that had marked them for so long.

"Jeremiah is preeminently the prophet of the heart, for he used the word over sixty times."<sup>127</sup>

4:15 Already a voice, probably that of a watchman, from Dan, in the far north, and from Mount Ephraim, in the north but much closer to Judah, was heard warning of the coming invader. Mount Ephraim is a reference to the mountains in the territory of Ephraim.<sup>128</sup> This voice may refer to the testimony of the Northern Kingdom that had already been overrun by another similar invader from the north, Assyria.

4:16 The Lord continued to tell Jeremiah to announce to all nations, as well as to Jerusalem, that besiegers were coming from a distant country and would lift their battle cries against Jerusalem.

4:17 This enemy would surround the capital and observe the city carefully, as a watchman stood guard over his field to detect any possible irregularities. This invasion would come on Jerusalem because the people had rebelled against Yahweh.

4:18 God's people had brought this punishment on themselves by breaking the Mosaic Covenant. God was not acting arbitrarily. Their evil had been great, but it had not moved them to repent.

---

<sup>127</sup>Wiersbe, p. 81.

<sup>128</sup>See Yohanan Aharoni and Michael Avi-Yonah, *The Macmillan Bible Atlas*, maps 8, 64, 86, 113, and 125. This was "the last large section of Palestine to be crossed before one reaches Jerusalem" (Graybill, p. 663).

### The anguished response of Jeremiah 4:19-22

This section is the first of Jeremiah's so-called "confessions."<sup>129</sup>

4:19 Jeremiah complained that his heart was pounding and he felt very upset because he had heard the Lord's announcement of impending invasion and destruction.

". . . it would be hard to find a sharper description of uncontrollable inner turmoil . . ." <sup>130</sup>

4:20 The prophet understood that this announcement meant sudden and complete devastation for Judah.

4:21 He longed to stop hearing this bad news and seeing the signal that indicated the need to flee for safety (cf. v. 6).

4:22 The Lord complained that His people were foolish, like stupid children. They did not really understand Him but felt they could deceive Him and that He would not bring them to account for their sins. They were clever when it came to sinning, but not clever at all when it came to understanding that He would punish their sins (cf. Prov. 1:2-3).

"These verses of confession illuminate the internal torment of a man who is torn, precisely because he is himself so gripped by the urgency of his public preaching. He is not stern in public because he is heartless; it is because he loves his nation and people so dearly that he speaks the severe word, but it takes a terrible toll on his own emotional life."<sup>131</sup>

### A vision of the coming destruction 4:23-26

"In one of the most magnificent lyrical passages in the entire prophecy [vv. 23-31], Jeremiah experiences a dramatic moment of insight concerning the outpouring of divine anger upon Judah."<sup>132</sup>

4:23 Jeremiah described the land of Judah after the coming devastation as completely desolate, like the earth and heavens before God formed and filled them. He suggested that they would return to primeval chaos.

4:24 He described the mountains, symbols of stability and strength, as moving back and forth. This was a picture of instability and weakness for the people.

---

<sup>129</sup>See Thompson, pp. 88-92.

<sup>130</sup>Kidner, p. 39.

<sup>131</sup>Craigie, p. 79.

<sup>132</sup>Harrison, *Jeremiah and . . .*, p. 72.



- 4:25 The people had deserted the land, and even the birds were gone, so thoroughly had this enemy purged the land.<sup>133</sup>
- 4:26 The Lord's fierce anger had resulted in the land becoming wild and the cities destroyed.

"The picture is so extreme that only our present forebodings of nuclear winter may seem to come within sight of it."<sup>134</sup>

### **An oracle concerning the coming destruction 4:27-31**

- 4:27 The Lord promised to destroy the whole land but not completely. A remnant of His people would survive the disaster.
- 4:28 Yahweh's fixed purpose to bring this destruction on Judah was such bad news that even the earth and heavens would mourn upon hearing His plan.
- 4:29 The inhabitants of every Judean city would run and hide when they heard the enemy coming (cf. Isa. 2:19-21; Rev. 6:15-16). The result would be vacant cities throughout the land. Archaeological monuments have shown that the Babylonians were a people of archers.<sup>135</sup>
- 4:30 The Lord asked Judah what she would do then. Presently she pursued selfish interests and tried to make herself as attractive as possible, like a harlot, but the nations that pretended to love her would turn against her and attack her (cf. Rev. 17). No last-minute compromise with the invaders would placate them. The unfaithful wife of Yahweh would reap judgment for the profligacy she had sown (cf. 3:1; 2:35-36).
- 4:31 Judah would cry out like a woman giving birth for the first time. She would be in agony because of the adversaries who had come to put her to death. Neither pretty words (v. 30) nor a pitiful cry (v. 31) would turn the Lord back from His decision to judge His people.<sup>136</sup>

". . . Jerusalem's demise [in a fatal miscarriage] would be like that of a prostitute giving birth to a firstborn bastard."<sup>137</sup>

### **The depth of Judah's sin 5:1-9**

Now God gave His people reasons for the coming judgment. He stressed social and personal sins particularly.

---

<sup>133</sup>Contrast the descriptions of chaos in verses 23 and 25 with the descriptions of creation in Gen. 1:2, 3, 8, 10, 20, and 26. See also Job 3:3-13.

<sup>134</sup>Kidner, p. 40.

<sup>135</sup>Feinberg, p. 411.

<sup>136</sup>Jensen, p. 31.

<sup>137</sup>Craigie, p. 84.

"Jeremiah now appreciates the moral necessity for God's judgment of His people, as he sees clearly with his own eyes the iniquity, selfishness and depravity of life in Jerusalem."<sup>138</sup>

5:1 The Lord challenged Jeremiah to search Jerusalem for a man who was just and sought the truth.<sup>139</sup> If he could find even one, on his "scavenger hunt,"<sup>140</sup> the Lord promised to pardon the city (cf. Gen. 18:23-32).

"Obviously some godly people like Josiah, Baruch, Zephaniah, and Jeremiah himself were living in Jerusalem. But the words certainly applied to the mass of the populace. In short, corruption was so widespread that exceptions were not significant (cf. Ps. 14)."<sup>141</sup>

Justice and truthfulness are two terms that often appear together in the prophetic literature of the Old Testament. They are covenant qualities that govern relations between people and God and between people and other people.<sup>142</sup>

5:2 The Jerusalemites used the Lord's name to swear by, but then they showed no respect for Him by breaking their promises made in His name. When a person swore by Yahweh's name he or she called on the Lord to punish him or her if the person swearing violated the terms of the oath.

5:3 Jeremiah acknowledged that even though the people of Jerusalem did not seek truth (v. 1) the Lord did. The prophet knew that Yahweh's discipline of the people had not yielded repentance. They had hardened themselves against Him and had refused to repent (Heb. *shub*).

"Jerusalem was to fall at the hands of the political enemy from without because of the spiritual enemies of God working from within."<sup>143</sup>

5:4-5 Jeremiah, as he searched for righteous people in the city, initially concluded that only the ignorant and foolish ordinary citizens were blind to God's ways and laws. But as he continued to investigate he discovered that the informed leaders among the people had also rebelled against the Lord.

5:6 Therefore, the people of Judah would become prey for their savage animal-like enemies (cf. 2:15; 4:7; Hos. 13:7-8; Hab. 1:8; Zeph. 3:3).

---

<sup>138</sup>Harrison, *Jeremiah and . . .*, p. 74.

<sup>139</sup>According to later Greek literature, Diogenes similarly searched Athens for an honest man.

<sup>140</sup>Dyer, "Jeremiah," p. 1137.

<sup>141</sup>Feinberg, p. 412.

<sup>142</sup>Thompson, p. 236.

<sup>143</sup>Jensen, p. 31.

"The lion represents strength, the desert wolf ravenousness, and the leopard swiftness—all traits of the Babylonians."<sup>144</sup>

When the Judahites would try to leave their towns, the foe would devour them. The reason was they had transgressed Yahweh's covenant greatly and had departed from Him many times. The eighth-century B.C. Sefire Treaties contain references to lions and leopards ravaging people in fulfillment of a treaty curse.<sup>145</sup> The Judahites were familiar with wild beasts attacking and killing humans outside their cities (cf. 2 Kings. 17:25).

5:7 Yahweh asked the people why He should pardon them. Their sons, for whom the older generation was responsible, had forsaken Him and trusted in idols. As payment for blessings He had sent them, they proceeded to commit adultery with the Canaanite gods and their human representatives.

5:8 They were like well-fed stallions that used their strength to pursue illegitimate mates, even their neighbor's wives. Spiritual adultery led to physical adultery.

"They used their affluence for sin. Does that sound familiar? Consider modern dramas, novels, movies, painting, sculpture. In the midst of the affluent society often the artist's answer is a call to the hedonistic life."<sup>146</sup>

5:9 Was it not just for Yahweh to punish such a people and to take vengeance on them for their sins (cf. v. 7)? It certainly was just, as verses 7 and 8 amply demonstrated (cf. Eph. 5:5; Heb. 13:4).<sup>147</sup>

#### **Judah's false security 5:10-19**

5:10 Speaking to the invading soldiers that He would use to judge Judah, the Lord instructed them to prune His vine (cf. Isa. 5:1-7). However, they were to leave a remnant (cf. v. 18). They were to take many branches away because they were not His, namely, not faithful to Him (cf. John 15:1-6; Rom. 11:17-24).

5:11-12 Both the Northern and Southern Kingdoms had behaved treacherously toward the Lord. They had lied about Him saying that He would not judge them by sending misfortune, war, or famine to touch them. They denied God and His warnings about judgment (cf. Gen. 3:4). They were blind due to complacency.

---

<sup>144</sup>Feinberg, p. 413.

<sup>145</sup>See T. Wittstruck, "The Influence of Treaty Curse Imagery on the Beast Imagery of Daniel 7," *Journal of Biblical Literature* 97 (1978):100-102.

<sup>146</sup>Schaeffer, p. 40.

<sup>147</sup>Note that questions frame verses 7-9.

5:13 There were many prophets in both kingdoms whose alleged prophecies were nothing more than hot air (wind, Heb. *ruah*, also translated "spirit"). They did not utter the Lord's words. God indeed would bring judgment on His people.

"The essence of true prophecy was the *spirit* of God, but such was their blindness, or willful ignorance, that they could not discern between *wind* and the true *spirit* of prophecy."<sup>148</sup>

5:14 Yahweh, the ultimate power and authority in the universe, promised to make the messages that He had put in Jeremiah's mouth for the people like fire, not like hot air. His words would consume them in the sense that they would result in the people's destruction if repentance did not follow.

5:15 The Lord promised His people, called Israel here, that He would bring destruction against them by consuming them with Jeremiah's fiery words. The destroyer would come from a distant nation whose language they did not understand; it would not come from some nearby nation (cf. Deut. 28:49).

"Though Judah might appeal for mercy, the language barrier would prevent her cries from being heeded because they would not be understood."<sup>149</sup>

This nation was old and enduring. Babylon traced its origins back to Babel (Gen. 10:10; 11:1-9, 31).

5:16 The enemy soldiers' yawning quivers would be like open graves in that their arrows would slay the Judahites and send them to other large openings—in the ground (cf. Ps. 5:9). All the enemy soldiers would be mighty warriors, not just citizens recruited for military duty.

5:17 These soldiers would devour and demolish everything that the Judahites owned and trusted in for security.

5:18 In spite of such a thorough destruction, the Lord promised not to wipe out His people completely (cf. v. 10). He would be faithful to His covenant promises even though His people were unfaithful to their covenant responsibilities (cf. 2 Tim. 2:13).

5:19 When the people asked Jeremiah for an explanation of their circumstances, he was to tell them that since they had forsaken serving Him and worshipped idols in His land, the Lord was sending them to serve

<sup>148</sup>Craigie, p. 92.

<sup>149</sup>Harrison, *Jeremiah and . . .*, p. 77.

strangers in the land of those idols. This was only fair (recompense in kind, the *lex talionis*, cf. Deut. 28:47-48).

### **Yahweh's warning to His complacent people 5:20-31**

There were three aspects to Judah's failure: the people's perversity (vv. 20-25), their injustice (vv. 26-29), and their leaders (vv. 30-31).<sup>150</sup>

"Jeremiah rebukes the Judeans as a whole for their utter stupidity and lack of moral discernment. They have flaunted the covenant stipulations, and many ruthless individuals have prospered at the expense of the down-trodden."<sup>151</sup>

5:20-21      Jeremiah was also to deliver another message to the Judahites. He was to command them to hear even though they were foolish and heartless, blind and deaf to the Lord (cf. Isa. 6:9; Matt. 13:14-15; John 12:40; Acts 28:26).

"Although we have much sympathy for a man who cannot read because his eyes are sightless, our attitude is much different toward one who has never learned to read because of laziness or stubbornness. In a country where everyone has an opportunity to learn to read and write, illiteracy is regarded as an inexcusable tragedy. Spiritual illiteracy is little different. God is not sparing in His denunciation of those who have had a chance to know Him and His salvation but have despised the opportunity."<sup>152</sup>

5:22      Should His people not fear Him and tremble before Him since He sovereignly controlled the untamable sea? What they feared had no power over them because Yahweh controlled it. He was the one who also sovereignly controlled the borders of nations. The people of Judah had not observed the sovereignly ordained borders for their behavior in the Mosaic Law, and chaos was the result.

5:23      God's people had proved stubborn and rebellious at heart. Unlike the sea, they failed to submit to Yahweh's sovereignty (cf. 1:3). In their actions they had turned aside (Heb. *shub*), apostatized, and departed from the Lord and His covenant.

5:24      They did not acknowledge Yahweh as the source of the blessings of nature either. The Canaanites believed that Baal controlled the rains and fruitfulness of the land, and the Judahites had adopted their viewpoint. Nevertheless it was Yahweh, not Baal, who gave Israel her grain. The

---

<sup>150</sup>Craigie, p. 95.

<sup>151</sup>Harrison, *Jeremiah and . . .*, p. 77.

<sup>152</sup>Burton L. Goddard, *Meet Jeremiah: A Devotional Commentary*, p. 34.

"weeks of the harvest" were the seven weeks between Passover and the Feast of Weeks each spring. At those two feasts the Jews celebrated the Lord's goodness to them in giving them a good harvest (cf. Lev. 23:10, 17).

5:25 The people's sins had resulted in God withholding the blessings of nature from them as well as other good things. The reasons for their blindness were mainly moral rather than intellectual.

5:26-27 Many of the Judahites had wickedly tricked their neighbors and had accumulated wealth by deceiving them. They had put their fellow Israelites in their debt, robbed them of their freedom, and so caged them like birds (cf. Hab. 2:6, 8; Mark 10:19; 1 Thess. 4:6; Titus 2:10).

"Birds were snared with a net; men closed the net with cords when a bird came into it. Then the birds were put into a basket (. . . Mic 7:2)."<sup>153</sup>

5:28 These social bullies had grown fat (wealthy, cf. Deut. 32:15; Ps. 92:14; Prov. 28:25) at the expense of their neighbors so expert had they become in wickedness. Instead of giving special help to the needy among them, they had withheld assistance so they could keep their money for themselves.

5:29 Again the Lord asked rhetorically if punishment for this type of conduct was not just (cf. vv. 7, 9). Of course it was.

5:30-31 The Lord announced that an appalling and horrible thing had happened in Judah. The prophets did not deliver the Lord's messages but what the people wanted to hear. Also the priests conducted worship as they thought best rather than as the Lord had specified. But instead of revolting against these misleaders the people loved their apostate behavior. Yet, the Lord asked, what would they do in the end?<sup>154</sup> They could not avoid His judgment for breach of covenant.

"There is a straight line from apostasy to disaster, from sin to death."<sup>155</sup>

"When we listen to the religion that is largely preached in our generation, we hear the same thing the unbelieving philosophers and sociologists are saying. The only difference is that theological language is used. But God

---

<sup>153</sup>Graybill, p. 664.

<sup>154</sup>Compare the other questions in this chapter (vv. 7, 9, 22, 25, 29).

<sup>155</sup>Kidner, p. 45.

says, 'It will not do. This brings you under my judgment.'"<sup>156</sup>

### The siege of Jerusalem predicted 6:1-8

"The striking feature of this chapter is its rapidity of movement leading to the gathering storm of invasion soon to engulf the capital and the land."<sup>157</sup>

- 6:1 The Lord called the Benjamites, Jeremiah's tribal kinsmen, to flee for safety from the coming invader from the north (cf. 4:5-6). Jerusalem stood on the southern border of Benjamin. Benjamin's tribal border was the Hinnom Valley, which was also the southern boundary of Jerusalem.
- Tekoa, Amos' birthplace (Amos 1:1), was a Judean town about 10 miles south of Jerusalem, and Beth-hakkerem (lit. house of the vineyard) stood three miles south of Jerusalem. These representative villages needed to warn their inhabitants, with trumpets and signal fires, to flee in view of the destroyer's advance toward Jerusalem.<sup>158</sup>
- 6:2 The Lord would cut off Jerusalem, which He compared to an attractive and dainty young lady. Even though Jerusalem was attractive to the Lord, He would still bring destruction on her.
- 6:3 The enemy leaders and their soldiers would camp around Jerusalem like shepherds with their sheep (cf. 4:17; 12:10). Even though Jerusalem lay in a pleasant pastoral setting, its beauty would not deter the Lord from destroying her.
- 6:4-5 These enemies would encourage themselves to attack Judah's capital before they lost their opportunity. They would be so eager to destroy the city that they would even attack at night, a highly unusual practice.
- 6:6 In attacking Jerusalem the enemy soldiers would be responding to the instructions of Yahweh of armies to cut down the trees around the city to make implements of war and to lay siege. Jerusalem was due for punishment because its people were responsible for so much social oppression.
- 6:7 The residents had an unusual ability to keep wickedness as fresh as wells kept water fresh (cf. Prov. 4:16). Wicked violence and destruction had resulted in all kinds of sickness and wounds.

---

<sup>156</sup>Schaeffer, p. 53.

<sup>157</sup>Feinberg, p. 419.

<sup>158</sup>Tekoa, of all the northern Judean cities, may have been selected for literary reasons. In Hebrew its name, *teqoa'*, is very similar to the word translated "blow the trumpet," *tiq'u*. Beth-hakkerem may have been chosen for the meaning of its name since Jeremiah often referred to Judah as Yahweh's vineyard.

6:8 These announcements were to function as a warning to the people of Judah who still had time to repent before the enemy from the north would descend. If they did not repent, the results would be alienation from God (in captivity), the desolation of their city and their lives, and the ruination of their land.

"We may be reminded of the care lavished in our own day on presenting and practising [*sic*] an 'alternative morality', and may be warned, with Jerusalem . . ." <sup>159</sup>

### The breadth of Judah's guilt 6:9-15

6:9 The sovereign Lord promised that the coming enemy would remove the people of Judah from their land as a grape harvester removed the grapes from his vines (cf. 5:10; Isa. 5:1-6). The harvest would be so thorough that even the small number of Israelites left in the land would be taken captive.

The Lord also commanded Jeremiah to assess the nation as carefully as a grape gatherer examined the branches of his grapevine (cf. v. 27; 5:1). What follows in this pericope is what he discovered.

"All of Jeremiah's prophetic ministry, however fruitless it seemed, was a kind of grape harvesting, a gleaning of the vine of Israel. Jeremiah's task was to glean Israel. Once more he must return (*shub*) to the task to make certain that there was none remaining who had not heard his message." <sup>160</sup>

6:10 Jeremiah wondered to whom he could deliver this warning so they could benefit from it. The people he ministered to had closed their ears to his prophecies, and they were so steeped in sin that it was not even possible for them to hear. Messages from the Lord had become offensive to them, and they no longer welcomed them.

"This is the first of more than three dozen times in Jeremiah where the people did not listen to (i.e., they disobeyed) God's Word." <sup>161</sup>

6:11 Yet the prophet was full of messages announcing God's coming wrath that he felt incapable of containing. The Lord instructed him to pour out his pent-up messages of wrath on everyone in Jerusalem—children, adolescents, husbands, wives, older people, and the very aged—because all of them would be taken captive.

---

<sup>159</sup>Kidner, p. 45.

<sup>160</sup>Thompson, p. 257.

<sup>161</sup>Dyer, "Jeremiah," p. 1138.



"Ancient Near Eastern war was essentially total in nature, so that a city which resisted a siege unsuccessfully could only expect complete destruction, without respect to property, age or sex."<sup>162</sup>

- 6:12 The Lord would turn the people's houses, fields, and wives over to others. It would be the Lord Himself, acting in power, who would be responsible for this judgment on Judah.
- 6:13 Everyone was guilty and worthy of judgment, from all levels of society including the false prophets and the unfaithful priests. They all behaved selfishly and deceived others (cf. 4:3-5).
- 6:14 The leaders of the people had tried to heal the cancer of the populace with a bandage. They kept promising that everything would be all right, but there would be no peace because of Judah's sins.
- 6:15 These leaders did not even feel ashamed or embarrassed by their actions; they were completely insensitive to their sins (cf. 1 Sam. 15:22-23). Consequently they would fall along with the rest of the population when the Lord brought judgment.

"When evil is pursued and practiced regularly and devotedly, it produces eventually a moral blindness in the perpetrator."<sup>163</sup>

### **The inadequacy of mere ritual worship 6:16-21**

- 6:16 Yahweh commanded the Judahites to compare the paths in which they could walk. Then they should ask their leaders to direct them in the good old paths, the teachings of the Mosaic Covenant. Then they should walk in those ways and so experience rest (cf. Isa. 28:12; Matt. 11:28-29). But the people refused to follow those old paths. Probably they confused the ancient ways with obsolete ways, as many in our day do.

"The importance of the covenant for Jeremiah cannot be overrated. For him the covenant was fundamental to Israel's very life, involving as it did the acknowledgment of Yahweh as Israel's only sovereign Lord, and the glad acceptance of the covenant obligations. When Israel took this way she followed the ancient paths, the good way, and found rest. It was a theme to which Jeremiah returned again and again (7:22-23; 11:1-13; etc.)."<sup>164</sup>

---

<sup>162</sup>Harrison, *Jeremiah and . . .*, p. 81.

<sup>163</sup>Craigie, p. 104.

<sup>164</sup>Thompson, p. 261.

- 6:17 The Lord had set prophets over the people to warn them of their wicked ways, but the people refused to listen to them.
- 6:18-19 Because the people refused to listen to the Lord's words and had rejected His Law, the Lord announced to the whole earth that He would bring disaster on His people.
- 6:20 Even though the Judeans still worshipped God formally, their sacrifices made no impression on Him (cf. Isa. 1:11-14; Amos 5:21; Mic. 6:6-8). It was their true attitudes and actions that He saw.
- Sheba was a famous southwest Arabia (possibly modern Yemen) source for the incense used in the offerings (cf. 1 Kings 10:1-13; Ezek. 27:22). Sweet cane (calamus) was an ingredient in the anointing oil (Exod. 30:22-25; cf. Song of Sol. 4:14; Isa. 43:24) and was also an expensive import item perhaps coming from India. Burnt offerings were those in which the entire animal was offered up to God, and sacrifices were those offerings that were partially eaten by their worshippers.
- 6:21 Because of this hypocrisy, the Lord would trip His people up. He would humiliate them and interrupt their progress, probably with their own sins and with the coming invader. This would include all generations and involve people in all relationships (cf. v. 11).

#### **The people's response to the invader's attack 6:22-26**

- 6:22 Again Yahweh announced that people from a great and distant land would descend on Judah from the north.
- 6:23 They would be cruel warriors riding on instruments of warfare shouting loud battle cries and making as much noise as the roaring sea. Their target would be God's beloved residents of Jerusalem.
- 6:24 Jeremiah responded that the news of this invasion had made the people physically weak, mentally anxious, and extremely distressed (cf. 4:31). This is a proleptic (anticipatory) description of their reaction.
- 6:25 He counseled the people not to leave the city, to stay out of their fields and off the highways. There was an armed enemy out there waiting to kill them, and it should inspire terror among them all (cf. 20:3, 10; 46:5; 49:29).
- 6:26 The prophet called the people to repent while there was still time (cf. v. 8). Mourning over the untimely death of an only son was especially bitter because the family would then have no one to perpetuate the family name and line. Unless the people did repent the destroyer would overtake them.

### Jeremiah's evaluation of his people 6:27-30

6:27 Yahweh informed Jeremiah that He had given the prophet a roll in Judah that was similar to that of an assayer of metals. He would be able and be responsible to test the "mettle" of the Lord's people (cf. 5:1).

6:28 The Judahites were stubborn, rebellious, and deceitful. All of them were also hardened to outside influences, like bronze and iron, and were impure (cf. Mal. 3:3).

". . . the people of Judah are not, so to speak, precious metal marred by some impurities, but base metal from which nothing of worth can be extracted."<sup>165</sup>

6:29 The Lord had applied the fires of testing to His people, but still they remained impure.

"When lead was placed in a crucible with silver ore and heated, the lead became oxidized and served as a flux to collect impurities."<sup>166</sup>

6:30 Because the people were impure the Lord would reject them, as a silversmith rejects dross or slag. The implication is that He would toss them aside out of His land.

". . . the imagery is employed not to indicate that judgment would be a refining process but rather to convey its terminal nature; since no purity could be found, no solid silver, the mixture would be cast away as dross."<sup>167</sup>

Because of the possibility of repentance that Jeremiah referred to in chapters 2—6, most scholars believe that these messages date from the reign of Josiah and possibly the early years of Jehoiakim. This would place their origin between 627 and 609 or a little later. The possibility of repentance disappears later in the book probably indicating that Jeremiah delivered those prophecies later in his ministry.

Other recurring themes in chapters 2—6, which Jeremiah introduced in chapter 1, include the nations, uprooting and tearing down, destroying and razing, building and planting, and Yahweh watching over His Word. The coming invader from the north, wickedness, forsaking Yahweh, idolatry, and Judah's leaders and ordinary citizens are also prominent themes.<sup>168</sup>

---

<sup>165</sup>Kidner, p. 47.

<sup>166</sup>Thompson, p. 266.

<sup>167</sup>Craigie, p. 110.

<sup>168</sup>See Thompson, pp. 268-69, for further discussion.

## **2. Warnings about apostasy and its consequences chs. 7—10**

This is another collection of Jeremiah's prophecies that have in common the theme of Judah's departure from God and the consequences of that apostasy.

### **Aspects of false religion 7:1—8:3**

All the messages in this section deal with departure from the Lord in religious practices, either in pagan rites or in the perversion of the proper worship of Yahweh that the Mosaic Law specified. All the material in this section fits conditions in Judah after 609 B.C., when Jehoiakim began allowing a return to pagan practices after the end of Josiah's reforms. Another feature of this section is the large amount of prose material it contains, much more than the preceding section (chs. 2—6). The common theme is worship, and the key word is "place," though this word refers to different things in different verses (vv. 7:3, 7, 12, 14, 20, 32; 8:3).<sup>169</sup> From their contents we may surmise that these messages were undoubtedly responsible for much of the antagonism that Jeremiah received from the Judahites (cf. 26:7-24).

### **Jeremiah's Temple Sermon 7:1-15**

This message demonstrates a structure that is quite typical of many others in the Book of Jeremiah (cf. 11:1-17; 17:19-27; 34:8-22). First there is an explanation of Yahweh's will (word, law; vv. 1-7), then a description of Israel's departure from it (vv. 8-12), and then an announcement of divine judgment (vv. 13-15). A similar message, or the same message in abbreviated form, appears later in the book (26:1-6).<sup>170</sup>

7:1-2            Jeremiah received another message from the Lord. He was to go to the gate of the temple in Jerusalem and deliver a prophecy in Yahweh's name to the Judahites who entered to worship. This was probably the New or Eastern temple gate (cf. 26:10; 36:10).

". . . during the pilgrimage festivals in the temple, the pilgrims were greeted at the temple gates by a servant of the institution, who asked them to examine their moral lives prior to passing through the gates and participating in the worship (see Pss 15, 24 . . .). If Jeremiah assumed his role of 'preacher at the gate' in an unofficial capacity, then it is possible that the custom had lapsed at that time (as seems entirely probable from the substance of the sermon) and was consciously resumed by the prophet to his own moral and spiritual ends."<sup>171</sup>

<sup>169</sup>The places in view are the temple, Jerusalem, and Judah, but which one is in view is sometimes difficult to determine.

<sup>170</sup>Scholars differ about what they call Jeremiah's Temple Sermon. Some refer to all of 7:1—8:3 as the temple sermon, and a few consider 7:1—10:25 the temple sermon.

<sup>171</sup>Craigie, p. 120.

- 7:3 The prophet was to announce that sovereign Yahweh, the God of Israel, promised that if His people would repent (change their thinking, actions, and way of life) He would allow them to continue to dwell in their land.
- 7:4 The people were not to assume that just because they had the temple the Lord would keep them safe. Many of the Judahites believed that the existence of the temple guaranteed Jerusalem's inviolability. God's supernatural deliverance of Jerusalem in Hezekiah's reign probably accounts for some of this feeling (2 Kings 18:13—19:37). Furthermore, Josiah had glorified the temple during his reforms.
- "They [these Judeans] would argue that God had chosen Zion as his earthly dwelling place (cf. Ps. 132:13-14) and had promised to David and his descendants a kingdom for ever (2 Sam. 7:12-13). In the light of such promises it seemed to be a natural conclusion that God would not allow either his dwelling place (the temple) or his chosen ruler to come to any harm."<sup>172</sup>
- "The temple building itself had become the people's object of worship, replacing the *Person* of the building."<sup>173</sup>
- 7:5-6 Jeremiah proceeded to explain God's promise (v. 3). He listed three examples to illustrate what God wanted, two related to actions toward fellow Israelites and one related to actions toward God. True repentance meant dealing justly with one another, namely, refraining from oppressing the vulnerable such as strangers, orphans, and widows. It also meant not putting people to death without proper justification.<sup>174</sup> Godward, repenting meant not worshipping other gods, which the people were doing to their own ruin.
- 7:7 If the people did these things, then Yahweh would allow them to remain in the land that He had given their forefathers as a permanent possession (cf. v. 3; Gen. 12:7).
- 7:8 The prophet also explained what the Lord meant by trusting in deceptive words (v. 4), which they had been trusting in but without profit.
- 7:9 The people were committing robbery, murder, adultery, perjury, offering sacrifices to Baal, and following other foreign idols. These were all violations of Israel's law (Exod. 20:3-5, 13-16).

---

<sup>172</sup>Thompson, p. 277.

<sup>173</sup>Jensen, p. 37.

<sup>174</sup>The Mosaic Law demonstrates a profound concern for human welfare (cf. Deut. 14:29; 24:19-21; et al.).

7:10 The Judahites would commit these sins and then come to the temple, stand before Yahweh, and conclude that He had forgiven them. They would go through this ritual only so they could go out and sin again. They apparently felt that they had an indulgence that permitted them to go on sinning (cf. Eccles. 8:11).<sup>175</sup>

"They flee to the temple for protection, thinking to be safe there, believing that participation in the formal rituals of the cult would somehow deliver them from the Judge. But the temple was no sheltering place for covenant-breakers."<sup>176</sup>

The house that was called by Yahweh's name is a description of the temple that stresses that it was the building with which He associated His personal presence uniquely.

7:11 By treating the temple this way the people had turned it into a den of robbers, a gathering place for those who stole from others and God, and violated God's word with impunity (cf. Matt. 21:13; Mark 11:17; Luke 19:46).

"They have profaned God's house by making it a place of retreat between acts of crime . . ."<sup>177</sup>

The Lord assured the people that He Himself had seen what they were doing; they had not deceived Him.

7:12 Yahweh told the people to go to Shiloh to see what He had done to another town where He had met with the Israelites in former years (cf. Josh. 18:1; Judg. 18:31; 1 Sam. 1—4). In Jeremiah's day it lay in ruins.<sup>178</sup> Yahweh had allowed Shiloh to be destroyed because of the wickedness of the Israelites. Therefore Jeremiah's hearers should not think that He would preserve the temple from destruction in spite of their sins. The temple was not a talisman that guaranteed their safety.<sup>179</sup>

---

<sup>175</sup>Feinberg, p. 428.

<sup>176</sup>Thompson, p. 281.

<sup>177</sup>Harrison, *Jeremiah and . . .*, p. 86.

<sup>178</sup>The site was about 20 miles north of Jerusalem. The Philistines evidently destroyed the town in Eli's day, though the text does not say so specifically (1 Sam. 4). See H. Kjaer, "The Excavation of Shiloh 1929," *Journal of the Palestine Oriental Society* 10:2-3 (1930):87-174; and W. F. Albright, "The Danish Excavations at Shiloh," *Bulletin of the American Schools of Oriental Research* 9, pp. 10-11. The tabernacle that had stood at Shiloh then was still in existence in David's day (1 Chron. 21:29) and when Solomon began to reign (2 Chron. 1:3), so it did not suffer destruction with the city. Later references indicate that the town was rebuilt (1 Kings 14:2, 4). The Assyrian invasion of the territory of Ephraim, where Shiloh stood, may have destroyed it again.

<sup>179</sup>The Israelites had formerly also taken this view of the ark (cf. 1 Sam. 4:3).

- 7:13 The people had been sinning in the ways just enumerated for a long time. The Lord had sent them prophets and leaders who had warned them from the earliest days of their departure from Him, but they had refused to respond.<sup>180</sup>
- 7:14 Consequently, the Lord promised to destroy the temple and Jerusalem as He had destroyed Shiloh. He would do this even though the temple bore His name, His people trusted in it, and He had given it to them and their fathers.
- 7:15 Furthermore, the Lord would drive the Judahites from His sight in the land as He had driven their brethren in the Northern Kingdom from His sight, by sending them into captivity.

### **The Queen of Heaven cult 7:16-20**

This pericope continues Yahweh's instructions to Jeremiah preparing him to deliver the Temple Sermon (cf. vv. 1-2). Jeremiah may have received this message from the Lord at the same time or at some other time.

- 7:16 The Lord told His prophet not to waste his time praying for Him to be merciful to the people, even with earnest prayers, because they would not cause Him to relent (cf. 11:14; 14:11). The only thing that would prevent invasion, destruction, and captivity would be His people's repentance (cf. vv. 3, 5-7).
- 7:17 Yahweh reminded Jeremiah how far His people had departed from His ways.
- 7:18 Whole families were involved in making offering cakes for the Queen of Heaven. They also poured out drink offerings to other gods to hurt, humiliate, and annoy the Lord.

The "Queen of Heaven" was most likely a title of the Assyrian-Babylonian goddess Astarte (or Ishtar; cf. 44:17), though some scholars believe the name applied to several pagan goddesses.<sup>181</sup> Worship of the queen of heaven had been popular in Judah during the reign of Manasseh (2 Kings 21; 23:4-14), though it began earlier in Israel's history (Amos 5:26). This "queen" was an astral deity that appealed particularly to women (cf. 19:13; 32:29; Zeph. 1:5). Her worship involved offering cakes made in the shape of the deity or the moon, or stamped with her image, and drink offerings (cf. 44:19). Other symbols of this goddess were the planet Venus, a moon,

<sup>180</sup>The phrase "rising up early and speaking" was a favorite of Jeremiah's (cf. v. 25; 11:7; 25:3-4; 26:5; 29:19; 32:33; 35:14-15; 44:4). It occurs nowhere else in the Old Testament.

<sup>181</sup>Craigie, pp. 123, mentioned the Canaanite goddesses Anat, Ashtaroth, and Shapash, all of whom the Canaanites associated with heaven.

and a star. This cult had evidently survived Josiah's reforms, probably because people could worship Astarte in their homes. Worship of the Queen of Heaven and all other idols constituted a rejection of Yahweh's sole sovereignty as lord of Israel's covenant.

- 7:19 By provoking the Lord, the people were really hurting and humiliating themselves. Their flagrant disobedience would come back on them, and they would suffer for their sins.
- 7:20 The Lord promised to pour out His anger and wrath on the whole land of Judah because the people were doing these things. His judgment would affect people, animals, trees, and crops; in other words, it would affect everything in the land. Nothing would put out the fires of His anger—except genuine repentance (cf. vv. 3, 5-7).

### **Obedience as opposed to mere sacrifice 7:21-28**

This seems to be a new message from the Lord. It is a good example of prophetic indictments of Israel's sacrificial institutions (cf. 6:20; 1 Sam. 15:22; Ps. 51:16-17; Isa. 1:4-15; Hos. 6:6; Amos 5:21-24; Mic. 6:6-8).

- 7:21 Yahweh, the sovereign God of Israel, commanded His people to eat their whole burnt offerings (Heb. *'oloth*), which should have been burned up completely on the altar, as well as the sacrifices (Heb. *zebah*) that they only ate part of (cf. Lev. 3; 7:11-18; 22:18-23, 27-30). It mattered little to Him how carefully they observed His instructions about offering animal sacrifices to Him if their hearts were not right.

". . . to affirm that the prophets rejected the whole sacrificial system is to go beyond the evidence. It was not the system as such that was rejected but the operation of the system, which divorced sacrifices from obedience and took them out of the covenantal setting in which they found their whole rationale."<sup>182</sup>

- 7:22 God could say this because burnt offerings and sacrifices were not His primary concern. This should have been clear to the people as they remembered what He had commanded them when He redeemed them as a nation. He had given them the Decalog, which called for righteous conduct, before He gave them the cultic legislation, which specified the ritual of worship (cf. Exod. 20:1-17; 24:1-8). He had not given them the laws concerning burnt offerings and sacrifices until after they broke the Decalog.

---

<sup>182</sup>Thompson, p. 291.



- 7:23 Obedience to His words is what He commanded them then. It was more important that they obey Him than that they follow the procedures involved in presenting sacrifices that only symbolized their obedience. His ancient command to obey also contained promises of blessing if they would obey. Yahweh had promised to adopt Israel into a uniquely intimate relationship with Himself that would be beneficial for the Israelites (Exod. 19:5-6).
- 7:24 In spite of these promised blessings, the Israelites had not obeyed or even listened to the Lord's voice. They had followed their own advice, and their evil hearts had stubbornly refused to yield to His will. Instead of progressing toward blessing, they regressed into cursing.
- 7:25 Ever since the Exodus God had graciously arisen early to send His servants the prophets to urge the Israelites to follow Him (cf. v. 13). The image of God getting up early in the morning stresses the priority He gave to instructing His people.
- 7:26 In spite of these instructions, each succeeding generation of Israelites did not listen or pay attention. Instead they became obstinate in their disobedience and did even more evil than their fathers had done.
- 7:27 The Lord told Jeremiah that he was to pass along all these words to his contemporaries, but they would not listen to him any more than they had listened to the former prophets. He should call to them to respond to his message from the Lord, but they would not even answer him.
- 7:28 Jeremiah was to tell the people that they were a disobedient nation. They refused to accept correction from their Lord. They were not faithful (Heb. *'emuna*, cf. 5:1, 3; Hab. 2:4) to Him and His covenant.

#### **Sin in the Valley of Hinnom 7:29-34**

- 7:29 The people were to cut off their hair as a sign of grief.

"The command to cut off the 'hair' (lit., 'crown' . . .) is in the feminine in Hebrew, showing that the city (cf. 6:23—'O Daughter of Zion') is meant. The charge stems from the fact that the Nazirite's hair was the mark of his separation to God (Num 6:5). When he was ceremonially defiled, he had to shave his head. So Jerusalem because of her corruption must do likewise. Her mourning is because the Lord has cast her off. Because of her sin, the chief mark of her beauty must be cast away as polluted and no longer consecrated to the Lord."<sup>183</sup>

---

<sup>183</sup>Feinberg, p. 433.

They were to go up to a bare hilltop and lament their fate because the Lord had rejected and forsaken the generation of the Judahites on whom He would pour out His wrath (cf. v. 20).

- 7:30 The reason for this strange behavior was that the Judeans had done evil in the Lord's sight. Specifically, they had brought things into the temple that were detestable to the Lord and that defiled it. These were idols and other objects associated with idolatry (cf. 2 Kings 21:5; 23:4-7; Ezek. 8).
- 7:31 The people had also built a shrine at a site called "Topheth" in the Valley of Hinnom just south of Jerusalem.<sup>184</sup> They had offered their children as human sacrifices at this shrine during the reigns of Ahaz and Manasseh (2 Kings 16:3; 21:6), something that Yahweh never commanded nor even entertained in His thinking (cf. Lev. 18:21; 20:2-5; 2 Kings 23:10; Mic. 6:7). King Josiah had attempted to wipe out this horrible practice (2 Kings 23:10), but the people revived it after he died in 609 B.C. (Ezek. 20:25-26).<sup>185</sup> What the Judahites were doing in the Valley of Hinnom was not fundamentally different from some of the forms of abortion that characterize modern life.
- 7:32 Because of this gross sin, the Lord promised that in the future the site would have a new name: the Valley of Slaughter.<sup>186</sup> This would be appropriate because so many of the idolatrous Israelites would die there in the coming siege. The enemy would fill this valley with Israelite bodies because it would be an easy way to dispose of their corpses. In ancient Near Eastern culture, to die and remain unburied was an insult as well as a tragedy (14:16; Deut. 28:26; Ps. 79:3; Isa. 18:6). The law prescribed that even criminals should be buried (Deut. 21:23).
- "All too appropriately, the place where parents tried to buy their own safety at their children's terrible expense, would become an open grave for their own remains (32-33)."<sup>187</sup>
- 7:33 This future mass grave would become a feeding ground for birds and beasts. No one would frighten the animals away because the Israelites who remained alive would be taken away as captives. Being left unburied was a terrible curse.<sup>188</sup>

---

<sup>184</sup>The name "Topheth" may come from the Aramaic *tephath*, meaning "fireplace," "oven," or "hearth." The Hebrews made a play on its name by adding the vowels of *bosheth*, "shame," a name for Baal, to this word. Hinnom may have been a former owner of the valley. The idol worshipped there was Molech, a fire god. See also Dyer, in *The Old . . .*, p. 598.

<sup>185</sup>Yahweh's test of Abraham's faith involved obeying a command that apparently involved child sacrifice, but it did not (Gen. 22). For more information about child-sacrifice, see A. R. W. Green, *The Role of Human Sacrifice in the Ancient Near East*, pp. 173-87.

<sup>186</sup>Jesus used this valley as a figure for hell, "Gehenna" being a transliterated form of the Greek name of this site (Matt. 5:22, 29, 30; 10:28; 18:9; 23:15, 23; et al.).

<sup>187</sup>Kidner, p. 51.

<sup>188</sup>See R. de Vaux, *Ancient Israel: Its Life and Institutions*, 1:56-59.

7:34 At that future time the Lord would remove all the joy and gladness from Jerusalem and the other cities of Judah. The land would become a ruin due to the invader from the north.

"The joy of a wedding carries the happy anticipation of the birth of children, but a nation that sacrificed its children forfeited all right for such cheerful occasions."<sup>189</sup>

### **Astral worship 8:1-3**

"The sermon ends (if these verses, still in prose, should be taken with ch. 7) on a note which takes away the last shreds of comfort for those whose hopes or memories are bound up with Jerusalem."<sup>190</sup>

8:1 When the invasion from the north came (cf. vv. 32-34), the Lord declared, the enemy soldiers would dig up the bodies of kings, princes, priests, prophets, and ordinary citizens (cf. Amos 2:1). Thus they would add insult to injury. The ancients believed that the spirits of unburied people would have no rest in the netherworld.<sup>191</sup> Some of the reason for exhuming these corpses may have been to plunder the graves of the dead, a practice that was common in the ancient Near East.<sup>192</sup>

"Even in modern times, the opening up of graves and the throwing about of the bones of the departed is practiced as a mark of extreme contempt. In recent wars in the Middle East such desecrations and insult were perpetrated."<sup>193</sup>

8:2 The enemy soldiers would expose these bones to the sun, moon, and stars, which the Judahites had loved, served, followed, consulted, and worshipped.

". . . as if in fulfillment of the desires of the dead, their bones are laid out upon the earth, exposed to the very astral 'powers' whom once the dead had worshiped [*sic*]. And in the humiliation of the dead, their former heavenly masters were uncaring, complacently shining in the heavens, unconcerned about human fate on the face of the earth. Although in life the citizens of Judah had served these astral deities, offering them affection, soliciting their advice and counsel (much as their modern counterparts might read

---

<sup>189</sup>Craigie, p. 126.

<sup>190</sup>Kidner, p. 51.

<sup>191</sup>Graybill, pp. 665-66.

<sup>192</sup>Feinberg, p. 434.

<sup>193</sup>Thompson, p. 295, n. 2.

an astrological chart), in human death the futility of their actions was at last made plain."<sup>194</sup>

Worship of astral deities was popular in the days of Manasseh (2 Kings 21:3; 23:4) and later revived after Josiah's reforms (Ezek. 8:16). The land would resemble a bone yard because there would be few if any survivors from Judah to gather up the bones for burial (cf. ch. 37). Human bones would serve as fertilizer for the land instead of animal bones, which were often used for this purpose (cf. 16:4).

- 8:3 The scattered remnant who survived the invasion would consider death a more desirable alternative than life as displaced persons. They would feel this way because the lot of the living would be more miserable than that of the dead (cf. Lev. 26:36-39; Deut. 28:65-67; 2 Kings 25:5-7; Ps. 137; Rev. 9:6).

Some scholars believe that Jeremiah delivered this entire collection of speeches (7:1—8:3) at the temple (cf. 7:1-2). That may or may not be true. It is very difficult, if not impossible, to trace the origin of many of Jeremiah's undated prophecies, when and where he gave them originally.<sup>195</sup>

### **Incorrigible Judah 8:4—10:25**

The twin themes of Judah's stubborn rebellion and her inevitable doom tie this section of miscellaneous messages together. The section contains mostly poetic material, and the prophecies bear the marks of Jehoiakim's early reign (perhaps shortly after 609 B.C.).

#### **Blind complacency 8:4-12**

- 8:4 The Lord commanded Jeremiah to ask the people if it was not normal for people to repent after sinning. After all, when someone falls down, the natural thing is to get up. When one gets lost, he tries to get back on the right way as soon as possible.
- 8:5 But the people of Jerusalem had behaved unnaturally in continuing in their apostate condition. They insisted on being deceitful, and they refused to return to the Lord even though they had stumbled and lost their way. This was irrational behavior.<sup>196</sup>
- 8:6 The Lord had heard what the people were saying, which was not right. They were refusing to acknowledge their sin (cf. 5:1-3). They were headed for trouble, like a horse rushing headlong into battle.

<sup>194</sup>Craigie, p. 127.

<sup>195</sup>For a chart of his dated material, see Raymond B. Dillard and Tremper Longman III, *An Introduction to the Old Testament*, p. 302

<sup>196</sup>There are many occurrences of the Hebrew root *shub*, "repent," in verses 4 and 5.

8:7 The migratory birds that visited Palestine yearly knew instinctively when it was time for them to change direction and fly either north or south, depending on the season. But the Judeans had more specific direction from the Lord in His word and the promptings of His love. Yet they did not see that it was time for them to change the direction of their lives (cf. 5:22-23).

"In matters spiritual and moral we act with a perversity which is quite unlike our common sense at other levels, let alone the impressive wisdom of our fellow creatures (even the bird-brained, 7a!)."<sup>197</sup>

The Judahites were not even as smart as birds.

8:8 The people were claiming that they knew God's word and were obeying it. However, it was only because their experts in the law had perverted it that they could say such a thing (cf. 2 Pet. 3:16). The scribes kept official records, copied important documents, and taught the people the law.

8:9 The Lord's word through Jeremiah had exposed these "wise men." They had rejected the Lord's word, and that was not "wise."

8:10 Since all the spiritual leaders, from the least to the greatest, lived for money and persisted in their deceit, the Lord would give their wives and fields to new owners, namely, the invaders (cf. Deut. 28:30).

"Dark is the day when people reject God's Word. Darker it is when the ministers of the Word betray their holy commission."<sup>198</sup>

8:11 Those in positions of spiritual leadership had provided panaceas for the people by telling them that all was well, but all was far from well.

8:12 These leaders were not in the least ashamed of their conduct, not even enough to blush. Therefore the Lord would cause them to fall when the rest of the people fell in the coming invasion (cf. 6:12-15).

"Could men reach a stage of apostasy where they would never repent? Yes they could, and Judah had reached that point [cf. Heb. 6:4-6]."<sup>199</sup>

This passage is a scathing indictment of Judah's spiritual leaders.

---

<sup>197</sup>Kidner, p. 52.

<sup>198</sup>Jensen, p. 40.

<sup>199</sup>Thompson, p. 301.

**The fruitless nation 8:13-17**

- 8:13 The Lord also declared that He would snatch the Judahites from their land. He had gone forth among His people to gather a harvest of righteousness, but all He found on His vines and fig trees was withered leaves, no grapes or figs (cf. 2:21; 5:10; 6:9; Matt. 21:18-19; Luke 13:6-9; John 15:2). Consequently, He would remove their former blessings.
- 8:14 Jeremiah called his fellow countrymen to go with him to the walled cities where they could resist the invader for at least a little longer before they perished. He recognized that the coming judgment was from the Lord because the people had sinned so greatly. He compared their judgment to being given poisoned water ("gall" AV) to drink.
- 8:15 The people had waited for the peace and healing that the false prophet kept promising (v. 11), but it never came. Instead terror had overtaken them.
- 8:16 The invader could be heard approaching from the north. The people living at Dan, Israel's northernmost city, heard the army coming first. The whole earth shook because of the number and strength of the advancing army. Its purpose was to consume everything in the land including Jerusalem and its citizens.
- 8:17 The enemy would be like a batch of poisonous snakes that no one could charm that would bite the people fatally (cf. Num. 21:6-9).

**Jeremiah's grief over Jerusalem 8:18—9:1**

- 8:18 The prospect of this catastrophic invasion overwhelmed Jeremiah with sorrow. It made him weak, and he could not get over his anguish.
- 8:19 He could hear his people in captivity crying out bitterly. They longed for Jerusalem where their God was, their true King. Why was He not helping them? They remembered Him marveling that they had provoked Him by worshipping images and idols.
- 8:20 The time for divine deliverance had come and gone. The Lord had left them exposed to judgment, as grain left standing after the harvest.

"It would appear that we have here a popular proverb used in daily life when men encountered a hopeless situation from which no deliverance or escape seemed possible. Jeremiah pictured the people of Judah as having passed by one opportunity after another to repent of their rebellious ways and so be delivered or *saved* (Heb. *nosha'*) from coming judgment."<sup>200</sup>

---

<sup>200</sup>Ibid., p. 306.

8:21 Jeremiah was all broken up over the broken condition of his people. Dismay had seized him, and he could not stop mourning.

8:22 Gilead, east of the Jordan River, was a source for healing balsam, but no healing was forthcoming for Judah.<sup>201</sup>

"The balm referred to is the resin or gum of the storax tree. It was used medicinally (cf. Gen 37:25; Jer 46:11; 51:8; Ezek 27:17)."<sup>202</sup>

No physician was on the horizon either, even though Yahweh was Israel's Great Physician (Exod. 15:26). The prophet marveled that Israel's Great Physician had not provided healing for His people, but he knew that their affliction was judgment for their sins.

9:1 Jeremiah loved his people so much that he wished he had more tears to shed for those of them that had died (cf. 2 Sam. 18:33; Matt. 23:37; Luke 19:41-44; Rom. 9:1-5; 10:1). His empathy with his people's sufferings earned him the nickname "the weeping prophet" (cf. 13:17; 14:17).<sup>203</sup>

"It's unusual today to find tears either in the pulpit or the pews; the emphasis seems to be on enjoyment."<sup>204</sup>

### **Judah's depravity 9:2-9**

9:2 Jeremiah longed for a place of retreat in the wilderness where he could go to get away from his fellow countrymen.<sup>205</sup> Their spiritual adultery and treachery repulsed him.

9:3 The Lord added that they assassinated people with their words, which they used as arrows. They spoke falsehood more than the truth. They went from one evil thing to another giving evidence of no acquaintance with Yahweh (cf. Rom. 1:28).

9:4 The Lord advised His people to be on guard against their neighbors and not to trust their fellow Israelites because they all dealt deceitfully and slandered one another. The word translated "craftily" comes from the same Hebrew root as "Jacob," *ya'qob*. The people were behaving like Jacob at his worst. This was civil unrest at its worst.

<sup>201</sup>This is the source of the traditional American spiritual "There Is a Balm in Gilead."

<sup>202</sup>Feinberg, p. 439. See also P. J. King, *Jeremiah: An Archaeological Companion*, pp. 153-54.

<sup>203</sup>This is the last verse in chapter 8 in the Hebrew Bible.

<sup>204</sup>Wiersbe, p. 90.

<sup>205</sup>A few recent commentators take the first five verses of this pericope to be the words of God rather than Jeremiah, e.g., Page H. Kelley, *Jeremiah 1—25*, pp. 143-45. Kelley wrote the commentary on 8:4—16:21 in this volume of the Word Biblical Commentary, which appears in the bibliography of these notes after Craigie, the writer of the first part of the book.

- 9:5 They intentionally deceived their neighbors, cultivated the skill of lying, and pursued iniquity so strenuously that it wore them out.
- 9:6 Deceit was their environment so much that it prevented them from having much of a relationship with Yahweh. Note the recurrence of "deceit" and its synonyms in this pericope. They did not know God (v. 3), and they refused to know Him. Even though they studied deception (v. 5) they refused to "know" Him.
- "The verb *yada'*, 'know,' denotes much more than intellectual knowledge but rather that deep intimate knowledge that follows on the personal commitment of one life to another, which is at its deepest in the commitment of a man to God [cf. Amos 3:2]."<sup>206</sup>
- 9:7 The sovereign Lord promised to put the Judean sinners through a refining process and to assay their value because the present dear generation of His people was so wicked (cf. 6:27-30; Mal. 3:3). He could do nothing else.
- 9:8 The tongue of this "daughter" was as deadly as an arrow (cf. v. 3). Her words appeared to be peaceful, but she was really setting a trap for her neighbors. People greeted their neighbors amicably on the streets, but in their hearts they intended to do them harm.
- 9:9 Yahweh asked, interrogatively, if He should not punish such a nation for their deceits. His nation had become like all the other nations (cf. vv. 24-25). Should He not avenge Himself by punishing Judah for violating His covenant commands?

"The grief of God is caused not only by what the people have done to him but more especially by what they have done to each other."<sup>207</sup>

### **Jerusalem's ruin 9:10-16**

- 9:10 The Lord took up a lamentation on behalf of the land that suffered because of His people's sin. The coming invasion would leave the land deserted even by beasts and birds. The rest of this message indicates that the invasion had not yet taken place. Jeremiah was describing a future event as though it was already past.
- 9:11 The Lord would make Jerusalem a ruin where jackals (or wolves) would prowl freely without fear of human interference (cf. 10:22; 49:33; 51:37). He would also make the other cities of Judah uninhabited desolations. Jeremiah might have wanted to flee from Jerusalem to the wilderness (v. 2), but God would turn the city into a wilderness.

---

<sup>206</sup>Thompson, p. 310.

<sup>207</sup>Kelley, p. 145.



- 9:12 Yahweh called for some wise person to step forward, someone who could explain the reason for the land's coming desolate condition.
- 9:13 The Lord Himself provided the answer to His own question. The land would lay desolate because His people had abandoned His covenant with them, had not walked in its commandments, and had not paid attention to His messages to them. The Israelites had promised to do these things at Mount Sinai (Exod. 19:4-8).
- 9:14 Instead the people had followed their own desires and the Baals, just like their ancestors. Stubbornness was one of their chief sins (cf. Deut. 29:18; Ps. 81:13).
- "The threat of 'stubbornness' still exists today. It has been described as 'atrophy of the will.' When people stubbornly refuse to do right, the time comes when they cannot do right. Judgment then comes in the form of living in the prison you have erected for yourself."<sup>208</sup>
- 9:15 Because the people were stubborn the Lord promised to feed them with wormwood (instead of honey) and to give them poisoned water ("gall" AV, instead of milk) to drink (cf. 8:14; 23:15; Deut. 29:18; Matt. 27:34).<sup>209</sup>
- 9:16 He would also scatter them among nations that would be unfamiliar to them and their forefathers. Violence would follow them until the Lord had annihilated them. This would be the fate of many ungodly Judahites, not the whole nation (cf. 4:27; 5:18; 30:11).

### **A dirge over Jerusalem 9:17-22**

What follows is a brilliant prophetic elegy. It contains two pronouncements from the Lord (vv. 17-21 and 22).

- 9:17 The Lord called Jeremiah to summon the professional mourners (Heb. *meqonenoth*) to come forward.

"In the Middle East even today, on the occasion of deaths or calamities, mourning is carried out by professional women who follow the funeral bier uttering a high-pitched shriek. Some of the Egyptian tomb paintings depict boatloads of professional mourners with their hair and garments disheveled accompanying a corpse on its way to a burial."<sup>210</sup>

---

<sup>208</sup>Ibid., p. 148.

<sup>209</sup>Wormwood was a plant with a very bitter taste.

<sup>210</sup>Thompson, p. 316.

- 9:18 The Lord wanted these women to come quickly and mourn on His behalf, wailing and shedding many tears.
- 9:19 The reason for this mourning was that the residents of Zion would bewail their ruin and shame in having to leave the land as captives with their homes destroyed.<sup>211</sup>
- 9:20 Jeremiah instructed the professional mourners in the Lord's name to teach their daughters how to wail and to teach their neighbors a dirge.
- 9:21 Death had invaded the city like a plague. It had entered homes and palaces, and it was cutting off children and youths from the public places.<sup>212</sup>
- 9:22 Men too would die in the open fields and lie there uncared for, like dung or like scraps of wheat left after a harvest.

"Here we see Death as the Grim Reaper. The custom was for a reaper to hold in his arm what a few strokes of his sickle had cut. Then he put it down, and behind him another laborer then gathered it into bundles and bound it into a sheaf. So death was to cover the ground with corpses, but the carcasses would lie there unburied because of the paucity of survivors and the great number of dead [cf. Rom. 6:23]."<sup>213</sup>

### Proper grounds for boasting 9:23-24

This reflection on the nature of true wisdom contrasts strongly with the preceding dirge. In such crucial days, Judah's only hope lay in her relationship with God. The thematic connection with the context is judgment.

- 9:23 The Lord commanded that the wise and strong and rich should not take pride in their wisdom and strength and wealth.<sup>214</sup>
- 9:24 Instead, the person who felt satisfied should do so because he or she understood and knew Yahweh as a God who loves and practices loyal love

<sup>211</sup>In Jeremiah "Zion" is primarily Jerusalem seen as the dwelling place of God (cf. 8:19).

<sup>212</sup>It is possible that Jeremiah borrowed the figure of death entering through a window from Canaanite or Babylonian mythology, but this is impossible to prove. See J. B. Pritchard, *Ancient Near Eastern Texts*, pp. 134-35, for the Canaanite use of the figure, and S. M. Paul, "Cuneiform Light on Jer. 9, 20," *Biblica* 49 (1968):373-76, for discussion of the Babylonian use.

<sup>213</sup>Feinberg, p. 444.

<sup>214</sup>Walter A. Brueggemann, "The Epistemological Crisis of Israel's Two Histories (Jer 9:22-23)," in *Israelite Wisdom: Theological and Literary Essays in Honor of Samuel Terrien*, pp. 85-105, argued that Jeremiah ministered at a time when conventional wisdom was being challenged and that this fact accounts for much of the opposition that he faced.

(loyalty, loving kindness, steadfast love, unfailing devotion, merciful love, Heb. *hesed*), justice (Heb. *mishpat*), and righteousness (right, integrity, deliverance, salvation, Heb. *sedaqa*) on the earth. Truly knowing the Lord in this way implies participating with Him in valuing and practicing these essential covenant virtues. The standard is not social custom or community consensus but the character and will of Yahweh (cf. 1 Cor. 1:31; 2 Cor. 10:17; James 1:9).

". . . true religion consists in a personal and existential knowledge of God, and in a commitment to those qualities displayed by Yahweh himself—unfailing loyalty, justice, and right dealing."<sup>215</sup>

This verse is a concise summary of Israel's religion at its highest. For Israel true religion consisted of acknowledging the sovereignty of God over all of life and allowing Him to produce the qualities that mark Him in the lives of all His people.

### **The worthlessness of circumcision 9:25-26**

Trust in religious ritual is just as wrong as trust in human achievements.

"Just as the knowledge of God is more important than wisdom, power, or might, even so faith that springs from the heart is more important than any outward show of religion."<sup>216</sup>

9:25           The Lord promised to punish those circumcised in one way but not in another in the future.

9:26           This would include the Gentile nations that practiced circumcision as well as Israel. There was no essential difference between these nations and Israel since they all practiced the superficial requirement of the Mosaic Law but had not really devoted themselves to the Lord wholeheartedly (cf. Gen. 17:9-14). They were the circumcised of body but not of heart (cf. 4:4; 6:10; Lev. 26:41; Deut. 10:16; 30:6; Rom. 2:25-29). It was only what circumcision symbolized that Yahweh accepted, not just the practice of the rite by itself. Certain Arab tribes trimmed their hair away from their temples (cf. 25:23; 49:32), which the Law forbade the Israelites from doing (Lev. 19:27), but they did practice circumcision. Thus Judah was no better than her neighbors and could expect punishment just as the pagan nations could.

### **A satire on idolatry 10:1-16**

This scathing exposé of the folly of idolatry resembles several polemics in Isaiah (cf. Isa. 40:18-20; 41:6-7; 44:9-20; 46:5-7). Verses 12-16 appear again in 51:15-19.

---

<sup>215</sup>Thompson, p. 318.

<sup>216</sup>Kelley, p. 154.

"Why did so easy a target as idolatry need so many attacks in the Old Testament? Verse 9 suggests one reason: the appeal of the visually impressive; but perhaps verse 2 goes deeper, in pointing to the temptation to fall into step with the majority."<sup>217</sup>

A study of the architecture of the passage reveals alternating assertions about idols (vv. 2-5, 8-9, 11, 14-15) and Yahweh (vv. 6-7, 10, 12-13, 16). The effect produced by this structure is contrast.

"Theologically these verses are of great significance, for they set Yahweh apart from every other object of worship. . . . As Lord of the covenant Yahweh demanded total unswerving loyalty from his subjects. Any attempt to share allegiance to him with another merited judgment, for it amounted to a rejection of the covenant. In that case the curses of the covenant became operative."<sup>218</sup>

- 10:1           The prophet again called his Israelite audience to hear the message that Yahweh had for them. There were people in Judah who were venerating idols who needed to hear this message.
- 10:2           He warned His people not to be disciples of the Gentile nations, specifically not to let the celestial phenomena that the nations looked to for guidance frighten them. The nations regarded abnormalities in the heavens as divine signs and held them in awe, particularly unusual phenomena such as comets, meteors, and eclipses. But it was Yahweh who controlled these things (cf. Gen. 1:14; Hab. 3:4, 11).
- 10:3           The worship of the Gentiles was an empty delusion. They worshipped only wood cut from the forest that a craftsman shaped with a tool. These gods were no more than pieces of wood.
- 10:4           They decorated their idols with precious metal and nailed them in place so they would not fall over. How ridiculous it is to worship something that cannot even keep itself upright, much less its devotees!
- 10:5           These idols were similar to scarecrows whose only power is to frighten birds. They did not speak to command, counsel, or comfort their worshippers. They could not walk to come to the aid of their devotees. People had to carry them; they were burdens to be borne rather than bearers of their suppliants' burdens. God's people should not fear them because they do neither harm nor good. They are do-nothing gods.
- 10:6           Yahweh, on the other hand, is unique among the deities that people worship. He is great, and He had a reputation for acting mightily.

---

<sup>217</sup>Kidner, p. 56.

<sup>218</sup>Thompson, p. 326.

- 10:7 People naturally fear Him (cf. v. 5) because He is the sovereign over all nations. The ancients believed that idols only had authority over certain geographical territories. Yahweh is also wiser than any wise men anywhere.
- 10:8 So-called wise men from the nations who worship a wooden idol are really stupid and foolish (cf. 1 Cor. 1:21). Their disciplined worship is just a delusion accomplishing nothing.
- 10:9 The idolaters imported silver from Tarshish to the far west, probably Tartessus in Spain, and gold from Uphaz (location unknown).<sup>219</sup> Craftsmen and goldsmiths then glorified these images that had no glory of their own. They dressed the idols up like little kings with royal-colored fabrics, but that did not make them kings since they were merely manmade artifacts.
- 10:10 Yahweh is the true God; idols are false gods. He is alive; they are dead, really nonexistent. He is the King who lives forever; they are only temporary and destructible. He controls the earth and makes it quake when He is angry; they have no power at all. The nations are unable to endure His indignation when He manifests it; the idols have no indignation and are impotent to manifest any feelings whatsoever.
- 10:11 Jeremiah instructed his audience to say that these idols would perish because they were human creations rather than the divine Creator.

This is the only Aramaic verse in Jeremiah.

"The Tg [Targum] prefaces v 11 with these words: 'This is the copy of the letter which the Prophet Jeremiah sent to the leaders of the exile in Babylon: "If the Chaldeans say to you, worship our idols, then answer them as follows.'" This suggests that v 11 was a shortened version of a letter sent by Jeremiah to Jehoiachin and the other exiles in Babylon [where Aramaic was spoken] between 598 and 587 B.C. (compare 29:1-32)."<sup>220</sup>

Another possibility is that this verse represents a well-known saying that someone, perhaps an Aramaic speaker, added to the text under divine inspiration.<sup>221</sup>

<sup>219</sup>Instead of place names, some translators believe refined silver and pure gold are in view. Some ancient versions substituted Ophir, a site in southern Arabia, for Uphaz.

<sup>220</sup>Kelley, p. 160. The Targums were interpretive translations of portions of the Hebrew Scriptures into Aramaic, which increasingly replaced the Hebrew language following the Babylonian captivity.

<sup>221</sup>Thompson, p. 330.

- 10:12 Yahweh is the Creator. His power, wisdom, and understanding were responsible for creating and establishing the universe.
- 10:13 He is responsible for the rains and storms, even the lightning, on the earth. He summons the winds from His celestial storehouse with a mere word, and they blow on the earth. The Canaanites attributed all these powers to Baal. Every thunderstorm testifies to the omnipotence of Yahweh.
- 10:14 Everyone who worships idols is stupid and ignorant (cf. 1 Cor. 8:4-6). Their inability to do anything shames those who glorify them.
- 10:15 Idols have no worth. They mock those who make them by their silence. And they are unable to defend themselves, so they perish whenever the true God chooses to humiliate them.
- 10:16 Yahweh, the God who gave Himself in a special relationship to such an unworthy person as Jacob, is not like the idols because He is the Creator. He adopted Israel as His special treasure among the nations (Exod. 19:5-6). He is Yahweh Almighty.

#### **A lament over the coming exile 10:17-25**

- 10:17 Jeremiah called those living during the siege of Jerusalem to pack their bags. He often warned his hearers of the coming invasion by speaking as if the enemy was attacking. Consequently it is very difficult, if not impossible, to date these prophecies unless they contain a more specific indication of their historical origin.
- 10:18 The Lord had announced that He was going to send Jerusalem's citizens away soon, as a shepherd throws a stone out of his sling. This would be a very distressing experience for them, but it would bring them to their senses.
- 10:19 The people, for whom the prophet spoke, bewailed their calamity viewing it as an incurable injury that the Lord had inflicted on them. Yet they realized that there was no escape from it and they had to endure the experience.
- 10:20 Their homes lay in ruins, and there was no one to help them rebuild them. Jerusalem, as a pitiful tent-dwelling mother, had lost her home and her children.
- 10:21 Israel's leaders, political and spiritual, had foolishly forsaken the Lord and His covenant, so they became failures, and their people scattered like sheep (cf. Ezek. 34).

10:22 The report of a great commotion in the north had reached Jerusalem. An invader was coming who threatened to destroy the towns of Judah so thoroughly that only jackals (or wolves) would inhabit them.

"There is not a single known case where a town of Judah proper was continuously occupied through the exilic period."<sup>222</sup>

In view of the coming invasion, Jeremiah prayed to Yahweh. Earlier God had told him not to pray that He would stop the invasion (7:16; cf. 11:14; 14:11-12). But here the prophet did not pray for that but for God to correct him (and Judah) and to judge the nations. He prayed for himself as a representative of the nation.

10:23 The prophet confessed that people do not have the wisdom to direct their own steps in safe and successful paths (cf. Ps. 37:23; Prov. 3:5-6; 16:9; 20:24).

10:24 He invited the Lord to correct him, to lead him in the proper way, but to do it with justice (without undue severity). If the Lord corrected him in anger, as the prophet (and his people) deserved, he would die. Jeremiah was probably speaking for his people as well as for himself in this prayer.

10:25 The Lord's anger should find its object in the nations that did not know Him and did not pray to Him but devoured, consumed, and desolated God's people, despicable as the Judeans were (cf. Ps. 79:6-7).

### **3. Warnings in view of present conditions 11:1—15:9**

#### **The consequences of breaking the covenant chs. 11—13**

This section provides an explanation for God's judgment on His people: the Judahites broke the Mosaic Covenant. It also contains two laments that portray the tragedy of the situation and the Lord's reluctance to send judgment. The final sub-section contains a symbolic action that pictures the horror of the people's sin.

#### **The broken covenant 11:1-17**

This passage consists of five short parts (vv. 1-5, 6-8, 9-10, 11-14, and 15-17). Most scholars believe it dates from the reign of Josiah, perhaps after the discovery of the Law but before he initiated his reforms (about 621 B.C.; cf. 2 Chron. 34:8-33).

11:1-2 The Lord's word again came to Jeremiah. The prophet was to listen to the words of the Mosaic Covenant and then address the people of Judah and Jerusalem.

---

<sup>222</sup>W. F. Albright, *The Archaeology of Palestine*, p. 142.

11:3-4 Yahweh, Israel's God, announced a curse on any of His people who did not obey the covenant that He gave their forefathers when He liberated them from their Egyptian hardships (cf. Deut. 4:20; 11:28; 27:26; 28:15-19; 29:20-21; 1 Kings 8:51; Isa. 48:10). At that time the Lord had commanded the Israelites to listen to His voice and to be completely obedient (cf. Exod. 19:5-6). By promising to do so they entered into covenant relationship with Yahweh; they became His special people and He became their national God (cf. 7:23; 24:7; 32:38).

"Ancient Near Eastern international treaties normally contained a section of benedictions and maledictions which were expected to occur according to whether or not the covenant was honoured."<sup>223</sup>

11:5 The Mosaic Covenant was to be the means by which God would fulfill His earlier promises to Abraham concerning the Promised Land (Gen. 12:7). Jeremiah replied, "So be it, Yahweh," a standard response to a covenant (cf. Exod. 19:8; 24:7; Deut. 27:15-26). He promised to do what God had just told him to do.

"There's no growth without challenge, and there's no challenge without change. As they get older, many people resist change, forgetting that without the challenge of change, they're in danger of deteriorating physically, mentally, and spiritually. God wanted Jeremiah to grow, and He also wants us to grow."<sup>224</sup>

11:6 Again the Lord instructed his prophet to bear a similar message to the same audience. Since the expression "in the cities of Judah and in the streets of Jerusalem" was proverbial for the length and breadth of the country, Jeremiah may not have carried on an itinerant preaching ministry.<sup>225</sup> The people were to listen to and obey the Mosaic Covenant as Jeremiah proclaimed it.

11:7 The importance of doing so was clear in that the Lord had commanded his people to hear and obey the covenant when He first gave it and ever since.

11:8 Nevertheless the Israelites had failed to listen and obey. Consequently the Lord had brought all the curses warned of in the covenant on them. The root of the problem was Israel's stubborn and evil heart.

"We are prone to hope that God will be like the modern indulgent parent and that there will be no reckoning if we,

---

<sup>223</sup>Harrison, *Jeremiah and . . .*, p. 95.

<sup>224</sup>Wiersbe, p. 95.

<sup>225</sup>Feinberg, p. 453.



also, disobey Him. It is a vain hope. Judgment is sure to come. As God punished Israel, so will He punish *all* whose hearts are confirmed in disobedience toward Him."<sup>226</sup>

- 11:9 Another word from the Lord informed Jeremiah of a conspiracy among his people.
- 11:10 They had returned (Heb. *shub*) to the sins of their forefathers who had rejected Yahweh's words and had pursued idols. This constituted breaking the covenant. Both the Northern and Southern Kingdoms were guilty, and the Northern Kingdom had already gone into captivity for its failure.
- 11:11 The result of this conduct would be disaster for them all. The Lord would bring this on them, and all their appeals to Him for relief would be of no avail. People who do not listen are not heard.
- 11:12 Receiving no relief from the Lord, the people would appeal to their idols, but they would not save them either.
- 11:13 The Judahites had worshipped multitudes of idols described hyperbolically as numbering as many as Jerusalem's streets and Judah's cities (cf. 2:28).
- 11:14 The Lord instructed Jeremiah again (cf. 7:16; 11:14) not to pray that He would withhold judgment from his people. Their sin was so great that the Lord would not defer judgment even though the prophet or his people cried out to Him for mercy (cf. v. 11). Genuine repentance was the only thing that would affect His punishment.
- 11:15 The Judahites, even though they were beloved by the Lord, had no right to come into His temple to worship Him because they had committed so many sins and had not repented. Their sacrifices alone could not make things right with Him. Judgment was inevitable.
- 11:16 Even though the Lord had compared His nation to a beautiful and fruitful green olive tree, He would burn it up in a great tumult because it had proved worthless as far as fulfilling His purpose for it (cf. 21:14; Ps. 52:8; 80:16; Isa. 27:11; Rom. 11:17-24). He would destroy the nation as He might destroy a tree by striking it with lightning.

"The olive [tree] was the source of oil for light, cooking, medicine, anointing for the body, and many other uses. It became the symbol of 'prosperity and divine blessing, of beauty and strength.' Thus it is here an apt picture of the Hebrew people, blessed by God, but now rejected."<sup>227</sup>

---

<sup>226</sup>Goddard, p. 56.

<sup>227</sup>Graybill, p. 667.

11:17 Even though Almighty Yahweh had planted Israel, He would bring evil (Heb. *ra'ah*) on her because she had done evil (*ra'ah*) by provoking Him by worshipping Baal.

"There is nothing in this oracle that does not appear in earlier oracles except that there is here a certain sense of the imminence of coming doom. Such language would certainly provoke the kind of reaction we find in 11:18—12:6, where we are told of a plot against Jeremiah's life in his own village."<sup>228</sup>

### **An attempt to kill Jeremiah 11:18—12:6**

This pericope contains one of Jeremiah's "confessions," a self-revelation of the prophet's own struggles to cope with God's actions (cf. 10:23-24; 15:10-12, 15-21; 17:9-11, 14-18; 18:18-23; and 20:7-18).<sup>229</sup> The heart of this one is 12:1-6.

11:18 Jeremiah announced that the Lord had revealed the fate of the Judahites to him and had given him insight into his people's deeds.

11:19 He had preached to the people without realizing that some of them were plotting his death. He was as unaware of their intention as a lamb going to its slaughter (cf. Isa. 53:7; Acts 8:32; 1 Pet. 2:21). They planned to get rid of him, the tree, as well as his messages, the fruit, so all memory of Jeremiah would end. This would be a tragedy since the existence of descendants demonstrated God's blessings on one's life under the Old Covenant.

"It will be recalled that Anathoth was the home of the priestly house of Abiathar, a friend of David. The house was deposed by Solomon, who supplanted it with the house of Zadok. Anathothites resented Jeremiah's favoring the deposition of the sanctuaries other than Jerusalem. This seemed to them like siding with Zadok against their own ancestor Abiathar. Furthermore, being priests, they doubtless hated his castigation of empty priestly ritual."<sup>230</sup>

11:20 The prophet prayed to Almighty Yahweh, who evaluates people's affections and intents, to judge them for their evil plans (cf. Ps. 17:13-14; 99:8; 149:7; Isa. 34:8; 35:4). He would not take vengeance himself, but he trusted the Lord to take vengeance for him.

11:21 Men from Jeremiah's hometown had warned him to stop prophesying in Yahweh's name or they would kill him.

<sup>228</sup>Thompson, p. 347.

<sup>229</sup>See Kelley, pp. 172-73, for an excursus on Jeremiah's confessions.

<sup>230</sup>Feinberg, p. 456.

11:22-23 The Almighty Lord promised to punish those men with disaster. The young men of military age would die violently, and others would die by famine, evidently during the siege of Jerusalem. The Lord would not leave them any descendants, so the memory of them would end. This would be fitting since they purposed to cut off all memory of Jeremiah (cf. v. 19).<sup>231</sup>

"The judgment may seem harsh, but this is just one of many instances in the Hebrew Bible where children experience the consequences of their fathers' sins. The principle of corporate solidarity was integral to Israelite thinking. Ancient Israelites realized that the actions of individuals profoundly affect others in their social context and that one's social context affects the individual adversely or positively."<sup>232</sup>

12:1 Jeremiah wanted some answers from righteous Yahweh, and he approached the Lord in prayer as though he were in court. He wanted to know why God allowed the wicked to prosper and the treacherous to live in ease (cf. Job 21:7; Ps. 37; 73:3-5, 12; 94:3; Hab. 1:12-17). It appeared to the prophet that the Lord, as well as Israel, had broken covenant (cf. Ps. 1:3-4).

"The problem of the prosperity of the wicked in the light of God's righteousness is not directly solved here or elsewhere in Scripture. The only final answer is faith in the sovereign wisdom and righteousness of God."<sup>233</sup>

12:2 The Lord had been responsible for these wicked people coming into existence, growing, and flourishing, like trees. This was a result of His "common grace" (cf. Matt. 5:45; Luke 6:35). They spoke freely about Yahweh, but they did not take Him into consideration.

12:3 The Lord knew that Jeremiah's attitude toward Him was entirely different than those hypocrites. The prophet prayed that the Lord would drag them off to punishment like sheep going to the slaughter (cf. 11:19). He prayed that God would reserve them for particular destruction, as He had set Jeremiah apart for his ministry (1:5).

12:4 The prophet continued to ask the Lord how long the promised judgment on the land would last. He knew it would come because of the people's wickedness in thinking that they could hide their sins from the Lord.

<sup>231</sup>God evidently meant that of those who persecuted Jeremiah none would have descendants since Ezra 2:23 records that 128 men of Anathoth returned from the exile.

<sup>232</sup>Chisholm, *Handbook on . . .*, p. 170. See also Joel S. Kaminsky, *Corporate Responsibility in the Hebrew Bible*.

<sup>233</sup>Feinberg, p. 457,

- 12:5 The Lord replied by asking Jeremiah how he expected to be able to endure the rigors of coming antagonism if the present hostility he was experiencing wore him out (cf. 11:19, 21; 23:21). If he fell in a relatively peaceful environment, how could he get through the turbulence to come, which resembled the violent, overflowing Jordan River in the spring. The Jordan Valley was a sub-tropical jungle inhabited by lions that was hard to penetrate at any season of the year (cf. 49:19; 50:44; 2 Kings 6:2).
- 12:6 Even Jeremiah's near relatives had been hypocritical with him and had spoken out against him, though they said nice things to his face (cf. Matt. 10:36).

"The plot against him [Jeremiah] and the injustice this represented was tied inextricably to the suffering and sin of the people. He was called to announce judgment upon the people. Being one of them caused him to suffer with them because of the Lord's judgment. As God's messenger, he suffered as a result of his prophetic ministry."<sup>234</sup>

"The world today needs more Jeremiahs who, in the midst of opposition, are true to the standards of the Bible, patient in the proclamation of the gospel, gentle in the hands of persecutors, committed to the protective care of the Chief Shepherd, and burdened for the souls of lost men and women."<sup>235</sup>

### **A lament about Yahweh's ravaged inheritance 12:7-13**

Most scholars believe this lament dates from the time when Jehoiakim revolted against Babylon after three years of submission (about 602 B.C.; cf. 2 Kings 24:1-2).<sup>236</sup>

"The second part of God's reply is remarkable, saying in effect, 'Your tragedy is a miniature of mine.'<sup>237</sup>

- 12:7 Yahweh mourned that He had forsaken the nation and abandoned His people to their captors (cf. Deut. 9:29; Joel 2:17; 3:2).<sup>238</sup> He had turned over the nation He loved, as a husband loves his wife, to others who were her enemies.
- 12:8 Judah had become like a lion roaring in defiance against Yahweh rather than as a noble leader of the Israelites (cf. Gen. 49:8-10). Judah opposed and turned against Him, and for this He had grown to hate (i.e., reject) "the beloved of my soul" (v. 7; cf. 9:1-10).

---

<sup>234</sup>Kelley, p. 181.

<sup>235</sup>Jensen, p. 48.

<sup>236</sup>Feinberg, p. 459.

<sup>237</sup>Kidner, p. 61.

<sup>238</sup>The verbs in this section are prophetic perfects, viewing future events as already past. The "house" may refer to the people, the land, or the temple, but the meaning is the same in any case.

- 12:9 Judah was like a different, colorful bird among birds of prey gathered all around her to attack her.<sup>239</sup> The Lord instructed His servants (the angels?) to assemble all the wild beasts that surrounded Judah to come and devour this bird.
- 12:10-11 Many of the foreign kings had ruined the Lord's people, like unfaithful shepherds sometimes ruined a vineyard. They had trodden the people down so that they had become as unproductive as a wilderness, completely desolate. Furthermore, Judeans did not express enough concern to do something about the situation; they failed to repent.
- 12:12 The Lord would bring destroyers on His people from the wilderness who would act as His sword and devour them. The whole land would experience war.
- 12:13 Because of the invasion the harvest that the Judahites would sow would turn out to be nothing but thorns (cf. Lev. 26:16; Deut. 28:38; Hos. 8:7; Mic. 6:15). All their labors to bring something profitable to fruition would come to nothing because their angry Lord would bring judgment on them.

#### **Death or life for Israel's neighbors 12:14-17**

This prophecy about Israel's neighbors anticipates chapters 46—51, which contain oracles against Gentile nations.

- 12:14 The Lord promised to judge Judah's neighbor nations that had robbed His people of what the Lord had given them. Many of these neighboring people would go into captivity as well as the people of Judah. Among these were the Egyptians, Assyrians, Edomites, Moabites, Ammonites, Arameans, and even the Babylonians.
- "Numerous ancient Near Eastern texts include the threat of exile among the lists of curses designed for evildoers, especially treaty-breakers."<sup>240</sup>
- 12:15 The Lord would have compassion on these neighbors of Judah's as well as on Judah and would bring some of them back to the land at the end of the captivity along with the Judahites (cf. 48:47; 49:6).
- 12:16 If these neighbors came to trust and worship Yahweh (cf. Gen. 31:51-53), as they had formerly taught the Judahites to trust in Baal, the Lord would accept them (cf. Ruth).

---

<sup>239</sup>Another translation possibility, represented by the Septuagint, is that Jeremiah described Judah as a hyena's lair surrounded by birds of prey ready to peck up the scraps that the hyenas left.

<sup>240</sup>Thompson, p. 360.

"At the same time, there is no concession to the old ways or the old gods—in our modern terms, to religious pluralism"<sup>241</sup>

Verses 15 and 16 will find fulfillment in the Millennium (cf. Gen. 12:1-3; Zech. 14:16; Rom. 11:15).

12:17 But if they would not respond to the Lord positively, the Lord promised to destroy these nations again (cf. v. 14; Zech. 14:9, 16-19).

"This passage gives us a rare glimpse into the consternation and anguish that evil causes God. The anguish is especially acute for him when his own people are responsible for it. In these verses the Lord expresses both love and hate for his people, emotions we usually consider mutually exclusive, at least for God. When the Lord opened himself up to his people in love, he also opened himself to the possibility of hurt."<sup>242</sup>

### **The linen waistband 13:1-11**

This is the first of several symbolic acts that Jeremiah performed to communicate divine messages (cf. 16:1-4; 18:1-12; 19:1-2, 10-11; 27:1—28:17; 32:1-15; 43:8-13; 51:59-64). Other prophets did the same thing (cf. Isa. 20:2-6; Ezek. 4:1-13; 5:1-4). This acted sermon confronted the Judahites with the polluting effect of their associations and the consequences.

13:1-2 The Lord instructed Jeremiah to purchase a linen waistband (or sash, Heb. *'ezor*) and to wear it without first washing it, which he did. Washing it would wear it out to some extent.

13:3-5 Sometime later the Lord told Jeremiah to take his waistband and go to *perathah* and hide it in a crevice in the rock there, which he did.

The Hebrew word *perath* describes the Euphrates River elsewhere in the Old Testament, and that may be its meaning here (cf. 46:2, 6; 51:63; Gen. 2:14; 15:18; Deut. 1:7; 11:24; 2 Kings 23:29; 24:7). If so, Jeremiah traveled at least 500 miles each way four times. Such a destination is understandable since the Euphrates was the source of the coming invasion of Judah and the destination of the Judahite exiles.

However, several commentators have suggested that the Hebrew word should be read differently, as *parah*, which refers to a site just four miles northeast of Anathoth, Jeremiah's hometown (cf. Josh. 18:23).<sup>243</sup> Since

<sup>241</sup>Kidner, p. 62.

<sup>242</sup>Kelley, p. 185.

<sup>243</sup>Still others believe the Hebrew word is an abbreviated form of the name Ephrathah, an old name of Bethlehem six miles south of Jerusalem (cf. Mic. 5:2). See Charles H. Dyer, "Waistbands, Water, and the Word of God: Where Did Jeremiah Bury His Girdle?" in *Integrity of Heart, Skillfulness of Hands: Biblical and Leadership Studies in Honor of Donald K. Campbell*, pp. 62-81.

Jeremiah's action was symbolic, he may not have made the long trip to the Euphrates to bury his waistband but may have hidden it in a closer place in the general direction of Babylon.

A third view is that this was a vision and Jeremiah never really went anywhere, except in his mind. But there are no clues in the text that this was a vision.

Regardless of where Jeremiah went, the meaning of the prophet's action is clear; it does not depend on our identifying his destination.

- 13:6-7 Again the word of the Lord came to Jeremiah after some time telling him to return to the same site and to retrieve the waistband that he had hidden there. When he did this he discovered that the waistband had become ruined and was of no more use.
- 13:8-9 Then the Lord told Jeremiah that He would destroy the pride of Judah and Jerusalem as the waistband had been destroyed.
- 13:10 The people of Judah, pure and untarnished at the time of their call (2:2-3), would be just as worthless as Jeremiah's ruined waistband because they had refused to listen to the Lord. They had been stubborn in their hearts (cf. Deut. 26:17-19) and had pursued idols by serving and worshipping them.
- 13:11 The Lord had purposed for His chosen people to cling closely to Him and to be an ornament of glory to Him, like a waistband served its wearer. But they did not listen to Him. They had become tarnished and spoiled by contact with polluting influences. Linen was a priestly material (Lev. 16:4), and similarly Israel was to be a priestly nation that was to cling to Yahweh (Exod. 19:6).

#### **The parable of the wine jars 13:12-14**

This parable stressed the destructive effects of Yahweh's judgment that were coming on the people of Judah because of their self-indulgence and complacency.

- 13:12 Yahweh, Israel's God, also told Jeremiah to instruct the people to fill all their jugs with wine. He could expect them to reply that they knew that this was the purpose of jugs. The prophet's words may have been a common cry among the local people who wanted more wine to drink.
- 13:13 Then the prophet was to explain that the jugs represented all the people of Jerusalem—the Davidic kings, the priests, the prophets, and the ordinary citizens. As the people filled their jugs with wine, the Lord would fill His people with the wine of His wrath. They had become intoxicated with

idolatry and probably with real wine. As drunkards, they would be unable to defend themselves in the critical hour of the coming invasion.

"Drunkenness was one of the major social problems in the ancient Near East, where the range of available beverages was considerably narrower than at present."<sup>244</sup>

13:14 The Lord would destroy His people, like jugs when they collided with one another and like drunkards when they stumbled into each other. He would not show pity on them. All generations of His people, from the oldest to the youngest, would suffer when He brought this destruction on them.<sup>245</sup>

#### **A final plea and warning 13:15-17**

13:15 Jeremiah called the people to pay attention and not to disregard what he would tell them because they thought it was unimportant. Yahweh had a message for them.

13:16 They were to give glory to Yahweh before the darkness of God's judgment overwhelmed them and they stumbled in their walk, as people descending a mountain at twilight. Presently there was some light for the people to walk in, and they were hoping for more light, but deep darkness was about to overtake them. Giving glory to the Lord is an idiom for confessing sins (cf. Josh. 7:19; John 9:24).

The historical background for this oracle may be the deportation of Jehoiachin in 597 B.C., which was as twilight compared to the darkness of 586 B.C. when Jerusalem fell and Judah lost her independence.<sup>246</sup>

13:17 If the people would not listen to the Lord's word, Jeremiah would weep profusely for them because their failure to listen would indicate that the people, like a flock of sheep, would be taken captive by an enemy.

"Let no one think that the good news of Jesus Christ is to be communicated in a cold 'take it or leave it' manner. Evangelical preaching and Christian witnessing must not be limited merely to a correct interpretation of the doctrines of the Word. We must have a love for sinners, so great a love that we will be driven urgently to unfold to them the way of salvation, whatever the cost."<sup>247</sup>

<sup>244</sup>Harrison, *Jeremiah and . . .*, p. 99.

<sup>245</sup>See William McKane, "Jeremiah 13:12-14: A Problematic Proverb," in *Israelite Wisdom: Theological and Literary Essays in Honor of Samuel Terrien*, pp. 107-20, for a technical study of this passage.

<sup>246</sup>Thompson, p. 369.

<sup>247</sup>Goddard, p. 66.



### A lament over the king and the queen mother 13:18-19

13:18 Jeremiah was to tell the king and the queen mother of Judah to humble themselves because the Lord had removed their authority or would remove it soon. Pride was a besetting sin of royalty. The individuals in view are probably young King Jehoiachin and his mother Nehushta (cf. 22:26; 2 Kings 24:8-17). They were taken to Babylon as captives in 597 B.C.<sup>248</sup>

The queen mother was an important official throughout Israel's monarchy, evidently as a counselor to the king, as was common in the ancient Near East (cf. 1 Kings 2:19; 15:13; 2 Kings 10:13). Queen mothers assumed unusual prominence because of the widespread practice of polygamy among the kings.

13:19 All the people of Judah had been or would be carried into exile, even those who lived in the Negev towns to the far south in Judah. That is, most of the people from all over Judah were involved. There were still some who did not leave the land in 586 B.C. (2 Kings 25:22). Jeremiah's statement in this verse is somewhat hyperbolic.

### Jerusalem's incurable wickedness 13:20-27

13:20 The Lord called Jerusalem to look north and she would see people coming.<sup>249</sup> The city was about to lose the flock of special people over whom the Lord had made her responsible, namely, His people of Judah.

13:21 What would the city say when the Lord appointed other rulers over her whom the leaders of Jerusalem had cultivated, namely, the Mesopotamians? This may be a reference to King Ahaz's earlier request for Assyrian help against Israel and Aramea (2 Kings 16:7; Isa. 8:5-8).<sup>250</sup> However, there were many times when Judah had relied on and courted Mesopotamian powers in the past (cf. 4:30). Jerusalem would be in agony over this situation, like a woman in labor pains.

13:22 If the people of the city asked themselves why such a state of affairs had overtaken them, they should remember that it was due to the greatness of their sins. The Lord would humiliate the city because it had humiliated Him. Lifting the skirt is a euphemism for sexual attack (cf. Lev. 18:6-19; 20:17; Deut. 22:30; 27:20; Isa. 47:3; Nah. 3:5), and exposing the heels seems to have been another one (cf. Deut. 28:57; 1 Sam. 24:3; Isa. 6:2).

13:23 The Jerusalemites were so steeped in evil that it was impossible for them to change. They could no more change than the dark Ethiopian could

<sup>248</sup>Less probably they were King Jehoiakim and his mother Zebidah (2 Kings 23:36).

<sup>249</sup>The imperatives in these verses are feminine indicating that probably Jerusalem is being addressed.

<sup>250</sup>Kelley, p. 193.

change the color of his skin or the leopard his spots. They had passed the point of no return; repentance was now impossible for them (cf. Heb. 6:4-6).

"Here is a classic example of loss of freedom of the will through persistent sinning. Sin becomes natural. Jeremiah is speaking of the force of habit, not denying freedom of choice (cf. John 8:34)."<sup>251</sup>

- 13:24 Because of their inveterate sinning the Lord would scatter the people from their land, like straw blown by the wind. Like the straw, they would end up in desert lands, namely, Babylonia.
- 13:25 This was the fate that Yahweh assigned the capital of Judah because she had forsaken Him and trusted in false gods.
- 13:26 Yahweh Himself would be the one responsible for Jerusalem's humiliation (cf. v. 22).
- 13:27 Her citizens had behaved like adulterers and like copulating horses (cf. 5:8). The Lord had seen their unfaithful, lewd behavior toward Him when they worshipped idols and practiced sacred prostitution in the open-air shrines across the land. Jerusalem was in big trouble. How long would she continue in her wicked ways and remain unclean?! The question expresses frustration more than it is a request for information.

### **Laments during a drought and a national defeat 14:1—15:9**

Evidently droughts coincided with the Babylonian invasions from the north. Most commentators believe that the droughts and the defeat that this section describes took place at about the same time because of what Jeremiah wrote.

#### **A lament during drought 14:1-16**

- 14:1 A message came to Jeremiah from Yahweh concerning some droughts (Heb. plural) that overtook Judah.<sup>252</sup> Droughts were a punishment for covenant violation in Israel (cf. Lev. 26:18-19; Deut. 28:23-24).
- 14:2 Judah was in mourning. Her cities were languishing, as when their gates sagged on their hinges. The people sat on the ground as an expression of their humbled condition. The people of Jerusalem were crying out for relief.

---

<sup>251</sup>Feinberg, p. 466.

<sup>252</sup>This pericope begins with an unusual formula, which occurs again in 46:1; 47:1; and 49:34.

- 14:3 The servants who had gone to draw water returned to their masters empty-handed. The cisterns, which collected rainwater in the cities, were dry. Even the wealthy nobles could find no water, and their servants covered their heads as though to protect themselves from heaven-sent calamity.
- 14:4 The farmers, the lowest persons on the social scale, likewise felt humiliated by the lack of rain. The drought had cracked their land open and had made normal farming impossible.
- 14:5 There was so little grass available that even the does, that normally took good care of their newborn fawns, deserted them to find grass to keep themselves alive.
- 14:6 Even the wild donkeys, known for their hardiness, could only stand and sniff the wind on hills since they could find nothing to eat. They panted and their eyes grew dim from lack of sustenance because death was near.
- 14:7 Jeremiah voiced a prayer for his people. He admitted that their iniquities, apostasies, and sins had been great. These terms for sin are all words that indicate breach of covenant. But he pled for Yahweh to do something for the people for His own reputation's sake, as a God of mercy, if not for theirs. Yet God is a God of justice as well as a God of mercy.
- 14:8 Yahweh had been Israel's hope (cf. 17:7, 13; 50:7; Ps. 71:5; Joel 3:16; Acts 28:20; Col. 1:27; 1 Tim. 1:1) and her savior in times of distress (cf. 2 Sam. 22:3; Ps. 106:21; Isa. 43:3, 11; 45:15; 49:26; 60:16; Hos. 13:4). But now He was acting like a stranger or a passing traveler. Such people normally have little real concern for the land through which they travel and the locals around them.
- 14:9 The prophet wondered why God was behaving like someone who, upon witnessing a catastrophe, was so dismayed that he just stood there with his mouth open and did nothing to help. God's lack of aid was especially surprising since He dwelt among His people and they were His chosen people. Jeremiah besought Yahweh not to forsake them.
- "There could hardly be a stronger set of pleas than those that the prophet pours out here: not only the reproaches of verses 8b-9a but the positive considerations that surround them, which are a model for any prayer of penitence."<sup>253</sup>
- 14:10 The Lord sent a message to His people. They had loved to wander from the path that He had prescribed for them to walk (cf. v. 8; Hos. 8:13; 9:9). They had departed from His will by seeking out the many idolatrous sanctuaries in the land and the foreign nations with which they could make

---

<sup>253</sup>Kidner, p. 66.

alliances. This was unacceptable behavior, and He would punish them for their sins.

14:11-12 The Lord further instructed Jeremiah not to pray for Him to turn back from punishing them (cf. 7:15; 11:14). Fasting and presenting sacrifices would not move Him to change either (cf. 5:12; 14:15; 27:8; 29:18; 2 Sam. 24:23; Isa. 51:19). He had determined to destroy them with the sword, famine, and disease, the classic trio of war accompaniments. This is "tough love."

"A theological question is raised as to whether it is ever proper to give up praying for anyone. Perhaps one may pray for them to come to repentance by way of divine judgment, but breach of covenant leads unerringly to divine judgment."<sup>254</sup>

14:13 Jeremiah suggested that the people were not totally responsible for their behavior. The false prophets had misled them by promising them lasting peace and prosperity.<sup>255</sup> He hinted that perhaps the Lord Himself was partially responsible since His prophets were misleading the people.

14:14 The Lord replied that He had not sent those prophets. Their prophecies were their own concoctions, not messages from Him. They had misread the covenant badly if they had concluded that disobedience would not bring inevitable punishment.

14:15 Because the false prophets had denied the coming warfare and accompanying famine they would die in it. This would be the proof that the Lord had not sent them and that they had been false to Him.

14:16 The people to whom the false prophets had made these promises would also die in the same ways. So many of them would die that there would not be enough people left alive to bury all the dead. This would be God's judgment on the people for their wickedness: many unburied corpses.

#### **A lament during a national defeat 14:17—15:4**

The national defeat pictured in this lament was a serious one. It may have been the first Babylonian invasion of Judah in 597 B.C., which resulted in severe destruction and exile for some Judeans.

14:17 Jeremiah was to tell the people that he had asked God to let him weep constantly because Judah, like a virgin daughter, had experienced a major tragedy. She had suffered a devastating blow and had incurred a severe injury.

---

<sup>254</sup>Thompson, p. 382.

<sup>255</sup>Jeremiah penned more about the false prophets than any other writing prophet.

- 14:18        Wherever Jeremiah went he saw dead corpses and people about to die from famine and its related diseases. Even the prophets and priests, who knew the land well, were wandering around in it as though they were in a foreign land.
- 14:19        Jeremiah asked the Lord if He had completely rejected Judah and had come to loath Zion, the place of His dwelling among His people. Why had he dealt Judah a fatal blow? When the people called on Him to send peace and healing, all He sent was silence and terror.
- 14:20        The prophet acknowledged that he and his people had sinned like their forefathers (cf. Ps. 51:1-4); they were not saying that they were sinless. He implied that this confession merited some mercy.
- 14:21        Jeremiah begged God for the sake of His reputation and honor not to abandon His people, not to break His covenant with them. He probably meant that God should not forsake the people with whom He had made a covenant at Mount Sinai. Of course, God never breaks His covenants even though people do.

"The nations knew him to be Judah's God, and any withdrawal of his help now would not be to his credit. Moreover, the destruction of Jerusalem would involve the destruction of the temple, his glorious throne (cf. 3:17; 17:12). . . . If he allowed calamity to touch his people or Jerusalem and its temple, this would cast a reflection on his power. Besides, he had a *covenant (berith)* with the people which must surely have involved him in the most profound of obligations to deliver them from their enemies."<sup>256</sup>

- 14:22        Yahweh was the only source of rain, not the idols or the astral deities, so Jeremiah's hope was in Him. He had brought calamity, and He alone could bring blessing.

"His [Jeremiah's] appeals were directed to: (1) *a tender physician*—'Hath thy soul loathed Zion? Why . . . is no healing for us?' (14:19); (2) *a forgiving God*—'We have sinned against thee' (14:20); (3) *an honor-preserving throne*—'Do not disgrace the throne of thy glory: remember, break not thy covenant with us' (14:21); (4) *an omnipotent Creator*—'We will wait for thee' to bring rain and showers, 'for thou hast made all these things' (14:22)."<sup>257</sup>

---

<sup>256</sup>Thompson, p. 386.

<sup>257</sup>Jensen, p. 52.

- 15:1 The Lord assured Jeremiah that even if two of Israel's most effective intercessors stood before Him and pleaded for the people now, they would not change His mind about bringing judgment. Moses had been effective in getting God to change His plans when Israel had been unfaithful (Exod. 32:11-14, 30-32; Num. 14:13-20; Deut. 9:13-29). Samuel had also obtained God's mercy for Israel when she had sinned greatly (1 Sam. 7:8-9; 12:19-25). But now these defense attorneys would prove ineffective, and the Lord would drive the guilty from His presence.<sup>258</sup>
- 15:2 If the people asked where they should go now, Jeremiah was to tell them that they would each go to their appointed judgment: death, the sword, famine, or captivity, the accompaniments of military invasion.
- 15:3 The Lord would assign four destroyers of His people: human warriors, dogs, birds, and beasts. These would be His agents in carrying out His sentence. The prospect of dying without burial was a horrible one for ancient Near Easterners, and being consumed by animals was even worse (cf. v. 16).
- 15:4 All the kingdoms of the earth would look on Judah's fate with horror. This judgment would come because of all the sins that wicked King Manasseh introduced into and revived in Jerusalem and throughout Judah (cf. 2 Kings 21:10-15; 23:26; 24:3). Manasseh was the most syncretistic of all the Davidic kings. This was especially deplorable since Manasseh was the son of one of Judah's most godly kings, Hezekiah. The wickedness that Manasseh was responsible for so saturated life in Judah, even after he died, that it was impossible to remove.

#### **A lament concerning Jerusalem's terrible fate 15:5-9**

Invasion and war had already overtaken Jerusalem when Jeremiah wrote this lament, but more destruction was to come (v. 9).

- 15:5 The Lord said that no one would have pity on Jerusalem when she had experienced His judgment (cf. Lam. 1:1, 12, 21; 2:13, 20).
- 15:6 The city had forsaken Yahweh. It had regressed rather than advanced morally and spiritually. The Lord promised to destroy her with His own power. He was tired of returning to a people who implored Him not to leave them (14:9). He was weary of waiting to judge a people who had grown weary of repenting (9:4).
- 15:7 He would also scatter the people of the outlying towns, as when a farmer winnows his grain by throwing it up to the wind that blows the chaff away

---

<sup>258</sup>See Thomas L. Constable, "What Prayer Will and Will Not Change," in *Essays in Honor of J. Dwight Pentecost*, pp. 99-113.

(cf. Matt. 3:12). Children would die because God's people did not repent. Former winnowings, like the exile of the Northern Kingdom in 722 B.C., had not brought the Judahites to repentance.

15:8 So many young men of military age would die that the land would be full of widows who would mourn the deaths of their sons (cf. 2 Chron. 28:6). This judgment would constitute a setback in the promise to multiply Abraham's descendants as the sand of the sea (Gen. 22:17).

15:9 The woman who had a perfect family and complete happiness would become so sad that she would hardly be able to breath (cf. 1 Sam. 2:5; Ruth 4:15). It would be as though the day of her rejoicing ended at noon. Her sun disappeared at noon with the death of her sons. She would have no heirs and comforters in her old age (cf. 14:3-4). It is possible that Jeremiah was personifying Jerusalem and or Judah as a widow, but a literal fulfillment is also probably in view (cf. Matt. 23:37-38; Luke 23:28-31).

The swords of the enemy would also devour many survivors of earlier invasions. This seems to indicate that one invasion of Jerusalem had already occurred when Jeremiah wrote this prophecy, probably the one in 597 B.C. (cf. 2 Kings 24:10-17).

<b>Deportations of Judahites to Babylon</b>	
First deportation	605 B.C.
Second deportation	597 B.C.
Third deportation	586 B.C.

#### **4. Warnings in view of Judah's hard heart 15:10—25:38**

This section of the book contains several collections of Jeremiah's confessions, symbolic acts, and messages. These passages reflect conditions that were very grim, so their origin may have been shortly before the fall of Jerusalem in 586 B.C.

#### **A collection of Jeremiah's personal trials and sayings 15:10—20:18**

This section of text is highly autobiographical. It contains, among other things, most of Jeremiah's so-called "confessions" (15:10-12, 15-21; 17:9-11, 14-18; 18:18-23; 20:7-18). This section can be a great help and encouragement to modern servants of the Lord.

#### **The prophet's inner struggles and Yahweh's responses 15:10-21**

This pericope contains two instances in which Jeremiah faced crushing discouragement in his ministry (vv. 10-14, 15-21). He confessed his frustration to the Lord, and the Lord responded with encouragement.

- 15:10 Jeremiah addressed his mother and mourned that she had borne him (cf. 20:14-18; Job 3:3-10). It is normal for a single man like Jeremiah to think of his mother when he gets lonely and discouraged. Since the Lord's call of him antedated his birth (1:5), cursing his birth was tantamount to rejecting God's call on his life. His ministry had produced much strife and contention, both for him and his people (cf. 11:18-20). He sounds like a lawyer who was tired of bringing accusations against his countrymen. He felt that everyone cursed him. Their disagreements with him did not spring from borrowing and lending, a common cause of animosity, but from his preaching. Today we would say that Jeremiah felt burned out.
- 15:11 The Lord told Jeremiah that He would set him free (of his own frustrations) so that he would be a force for good in the coming national crisis.<sup>259</sup> The enemy of Judah would even ask him for help in the coming distress (cf. 21:1-7; 37:1-10; 38:14-18; 42:1-6). Jeremiah would emerge from this catastrophe as a tower of strength.
- 15:12 The enemy from the north would be impossible to defeat, as strong as iron or bronze. What Jeremiah had been preaching would indeed come to pass.
- 15:13 Furthermore, the Lord would hand over the wealth of Judah to the enemy freely, as war booty, because of all her sins. The Lord knew what He would do and what was coming even if Jeremiah seemed to stand alone in a sea of unbelievers of God's Word.
- 15:14 The enemy would indeed carry Judah's wealth off to a distant land with which the Judahites were unfamiliar because Yahweh was angry with His people.

The following passage is similar to the immediately preceding one in that they both contain Jeremiah's confessions of complaint (vv. 10, 15-18) followed by the Lord's response (vv. 12-14, 19-21). However, this passage reveals a more serious crisis that Jeremiah faced.

- 15:15 Jeremiah asked Yahweh, who knows all things, to remember him and to punish his persecutors. He requested that the Lord not allow him to die because he had endured reproach for the Lord's sake.

"There is a boldness about such words which only those in a very close relationship with Yahweh may show."<sup>260</sup>

- 15:16 When the priests discovered God's Word in the temple during Josiah's reign (2 Kings 22:13; 23:2), Jeremiah had consumed it. He may have had a deep appreciation for God's Word even before that event. Whenever

<sup>259</sup>The Lord had similarly encouraged His prophet (12:5-6) after he had voiced his discouragement (12:1-4). And He would do so again, in the next pericope (vv. 15-21).

<sup>260</sup>Thompson, pp. 395-96.



Jeremiah began to relish God's Word, it had become his delight and a joy to his soul (cf. Ezek. 2:8—3:3; Rev. 10:9-10), in contrast to the majority of people who despised it (8:9). The Lord's words included his messages to the prophet as well as His written Word. Jeremiah's love for the Word was a result of God's initiative because Almighty Yahweh had called him to Himself (cf. 1:4-10).

One of the greatest blessings God can give His servants is a hunger for His Word. If you do not have it, ask Him to give it to you. Then cultivate a taste for it (cf. 1 Pet. 2:2).

15:17 Jeremiah had not spent his time with the people who disregarded God's messages to repent. Rather he felt indignation at their hard hearts and separated from them (cf. Ps. 1:1; 26:4-5). Their attitude repulsed him, and he felt under divine constraint to behave with integrity, in harmony with his preaching. Jeremiah felt that he had become a social leper (cf. Lev. 13:46).

"Every true servant of God is likely to experience tensions of this kind, especially if, like Jeremiah, his foes are his relatives (cf. Mt. 10:36)."<sup>261</sup>

15:18 The prophet asked God why his broken heart refused to heal (cf. 6:14). The Lord promised refreshment to His people, even Himself (2:13), but this had not been Jeremiah's personal experience. God seemed like an unreliable wadi (stream bed) to Jeremiah. It promised water but was completely dry for most of the year (cf. Job 6:15-20).

"The prophet Jeremiah found himself in a situation of conflict, conflict with his people and conflict with his God. He was at conflict with his people because of the message of judgment he proclaimed to them. He was at conflict with his God because he considered it unjust that he should suffer as a result of proclaiming God's message. He consequently complained to the Lord about his situation."<sup>262</sup>

15:19 The Lord replied that if Jeremiah would turn to Him he would find restoration and renewed strength to stand for his God. Jeremiah had been calling the people to repent, but he needed to repent of his self-pitying attitude (vv. 15-18). If he would purify himself inwardly (undergo a refining process), the Lord would continue to use him. Some of the people might turn to follow Jeremiah, but he must not turn to follow them. He must lift them and not allow them to drag him down.

---

<sup>261</sup>Harrison, *Jeremiah and . . .*, p. 103.

<sup>262</sup>Kelley, p. 212.

"Perhaps God was telling the prophet that he had been overconcerned about what people thought and said about him when his one concern should have been to heed God's word and proclaim it."<sup>263</sup>

15:20-21 If Jeremiah repented, the Lord would make him as indestructible as a bronze wall (cf. v. 12; 1:18-19). No one would be able to destroy him because the Lord would be with him and deliver him from his adversaries. He would rescue him from the wicked who would try to kill him and would free him from the grasp of those who would handle him violently.

"The antidote for the prophet's earlier 'Woe is me' [v. 10] was the Lord's 'I am with thee' (15:20). No better word could ever be given by God to one of His servants, anywhere or anytime! [cf. Matt. 28:20]."<sup>264</sup>

This passage appears to reflect Jeremiah's lowest point emotionally in his ministry.

### **The special conditions of Jeremiah's life 16:1-13**

Sometimes God used the events in the lives of His prophets to speak to the people as well as their messages.

"Hosea's unhappy marriage (Hos. 1—3), Isaiah's family (Isa. 7—8), the death of Ezekiel's wife (Ezek. 24:15-27), and Jeremiah's call to remain unmarried are all examples of the proclamation of the word through family events."<sup>265</sup>

16:1-2 The Lord commanded His prophet never (Heb. *lo'*) to marry and rear children.<sup>266</sup> The Israelites and ancient Near Easterners in general regarded the unmarried state and childlessness as divine curses (cf. Matt. 24:19; 1 Cor. 7:26), but here God overruled what was normal (cf. Gen. 1:28; 2:18; Deut. 7:14) for a special reason. Bachelors were so rare in Israel that there is no word for bachelor in the Old Testament. As an unmarried man, Jeremiah would have been the object of much derision and scorn.

16:3-4 The reason for this command was that the people living in Judah then were soon going to die horrible deaths; the exile was imminent.

---

<sup>263</sup>Thompson, p. 398.

<sup>264</sup>Jensen, p. 54.

<sup>265</sup>Thompson, p. 403. See also Isa. 20.

<sup>266</sup>In contrast, God commanded Hosea to marry and to have children (Hos. 1:2). This difference reflects God's sovereignty over His servants. His will for one may not be the same as His will for another in amoral matters.

"Jeremiah married no one, signifying the end of the relationship between the people and the Lord, and had no children, signifying the resulting destitution."<sup>267</sup>

Perhaps the Lord also wanted to spare Jeremiah the sorrow of seeing his wife and children die this way. The sorrow connected with the Babylonian invasion would be much greater than the joys of family life if he were to marry and father children.

16:5 The Lord also instructed Jeremiah not to visit those who were mourning over the death of a loved one.<sup>268</sup> He was not to comfort them because the Lord had withdrawn his lovingkindness and compassion from His people. Jeremiah's life was to remind the people of God's withdrawal from them.

"Not to show grief was abnormal and was cause for criticism."<sup>269</sup>

16:6-7 In the coming invasion, all classes of people would die and no one would bury them or lament their passing in traditional ways.<sup>270</sup> One of these ways was the meal that friends of the mourners provided after the funeral (cf. 2 Sam. 3:35; Ezek. 24:17; Hos. 9:4).<sup>271</sup>

"A consoling cup in later Judaism was a special cup of wine drunk by the chief mourner. This practice is not mentioned elsewhere in Scripture."<sup>272</sup>

16:8 Neither was Jeremiah to attend joyful celebrations or eat and drink with merrymakers. This is probably a reference to participating in wedding celebrations (cf. 7:34; 25:10; 33:11). Jeremiah's failure to fulfill social obligations, such as attending weddings and funerals, would have made him even more an object of social disgrace.

16:9 The reason for this antisocial behavior, Almighty Yahweh, Israel's God explained, was that He would soon end all rejoicing in the land. Jeremiah was to reflect the attitudes of His God in all these situations. His withdrawal from village life pictured Yahweh's withdrawal from His people.

---

<sup>267</sup>Kelley, p. 216.

<sup>268</sup>Ezekiel was not even to mourn when his wife died (Ezek. 24:15-27).

<sup>269</sup>Feinberg, p. 479.

<sup>270</sup>Even though cutting themselves and making themselves bald were contrary to the Mosaic Law (Lev. 19:28; 21:5; Deut. 14:1), the Israelites practiced these customs (cf. 41:5; 47:5; Ezek. 7:18; Amos 8:10; Mic. 1:16).

<sup>271</sup>See de Vaux, 1:59-61, for funeral customs.

<sup>272</sup>Harrison, *Jeremiah and . . .*, p. 105.

"It is one thing to grow eloquent over a dire prospect for a wicked nation; quite another thing to taste the medicine itself. To ask this of Jeremiah, denying him the cherished gift of wife and children (an almost unthinkable vocation at the time), and then to isolate him from sharing the occasions of sorrow and joy around him (5, 8), was the measure of God's intense concern to get the message across."<sup>273</sup>

- 16:10 The Lord prepared Jeremiah for questions that the people would ask him. They would wonder what they had done to deserve the great calamity that the prophet predicted. They had become blind to the sinfulness of their ways (cf. Mal. 1:6-7; 2:17; 3:7-8, 13).
- 16:11 He was to explain that the coming judgment was due to the accumulated sins of their forefathers in forsaking the Lord and His covenant and in practicing idolatry. Sin has a cumulative effect in that it results in conditions that affect the behavior of others, including later generations.
- 16:12 The punishment was also for their own sins, which were worse than those of their forefathers. They had been stubborn in their hearts and had not responded to the Lord's Word.
- 16:13 Therefore the Lord would hurl (Heb. *tul*) them out of the land and into a land that they and their forefathers had not known before.<sup>274</sup> There they would have their fill of idolatry, and the Lord would show them no mercy.

#### **Future blessings following imminent judgment 16:14-21**

The following three pericopes bracket assurance of imminent judgment for Judah with promises of distant blessing for Israel and the nations. This passage promises deliverance from the captivity for the Israelites. It appears again later in Jeremiah almost verbatim (23:7-8).

- 16:14 The Lord announced that the time would come when the chosen people would no longer look back on the Exodus as the great demonstration of His preservation and deliverance.
- 16:15 Instead they would look back on their second Exodus, from Babylon and all the other countries to which He had banished them. The Lord promised to bring His people back into the Promised Land that He had given their fathers after He had disciplined them there (cf. Gen. 12:7; Isa. 43:16-20; 48:20-21; 51:9-11).

---

<sup>273</sup>Kidner, p. 70.

<sup>274</sup>Obviously Abraham knew Mesopotamia, but none of the more recent ancestors of Jeremiah's generation had lived there.

The returns from Babylonian exile, therefore, were only part of the fulfillment of this promise. There must yet be a return of the Chosen People to the Promised Land "which I gave to their fathers" from all over the world. This will be a return after the Jews have repented (cf. Isa. 2:2-4; 18:7; 19:19-25; Zech. 8:20-23; 14:16; Mal. 1:11).<sup>275</sup> Therefore the present return of multitudes of Jews from all over the world to Palestine does not exhaust what God promised.

Even though there would be deliverance for Israel in the distant future, she could count on thorough judgment in the near future (vv. 16-18).

16:16 The Lord was going to summon fishermen (cf. Ezek. 12:13; 29:4-5; Amos 4:2; Hab. 1:14-17) and hunters (cf. Amos 9:1-4) to round up His people and take them as prey, even those who were in hiding. These agents would be the Babylonian invaders.

"When Jesus used the metaphor of fishermen to describe the mission of his disciples (see Mark 1:17; Matt 4:19), he was reversing its meaning from that intended by Jeremiah. Jeremiah's fishers caught men for judgment; Jesus' fishers caught them for salvation."<sup>276</sup>

16:17 The Lord saw everyone and everything. His people were not able to hide from Him even though many of them tried to do so.

16:18 Yahweh would pay them back double for polluting His land (cf. Isa. 40:2), which He had given them as an inheritance, with their iniquities and sins and with the dead bodies of their idols and abominable objects of worship.<sup>277</sup>

The next pericope returns to the note of hope in the distant future (vv. 14-15), but it promises blessing for the nations as well as Israel then (vv. 19-21).

16:19 Jeremiah composed a song to the Lord. He addressed Him as his strength, stronghold, and refuge in a time of distress (cf. Ps. 18:2). He foretold that the nations would come to the Lord from the ends of the earth confessing the futility of their lives and the lives of their forefathers (cf. 4:2; Gen. 12:1-3; Ps. 2; Isa. 2:1-3; 42:4; 49:6; Zech. 8:20-23; 14:16-17).

16:20 Rhetorically the prophet asked if humans can make gods for themselves. They can, but what they make are not really gods, because there is only one God.

<sup>275</sup>See Kaiser, p. 108.

<sup>276</sup>Kelley, p. 219.

<sup>277</sup>Paying back double may be an expression indicating proportionate payment, making the punishment equivalent to the crime, or it may be hyperbole for full payment. See *The New Bible Dictionary*, 1962 ed., s.v. "Archaeology," by D. J. Wiseman, p. 67a.

16:21 The Lord announced that in the future, when the nations sought Him out, He would convince them of His power and might, that they might know that Yahweh is the only true God (cf. Ezek. 36:22-23). He did not explain how He would do that here, but later revelation tells us that Messiah's second advent will involve such a demonstration of power that multitudes of people will turn to the Lord (Zech. 12:10).

### **Judah's indelible sin and sin's deceitfulness 17:1-18**

The next five sections (vv. 1-4, 5-8, 9-11, 12-13, and 14-18) continue the theme of Judah's guilt from the previous chapter. These pericopes have obvious connections with one another, but they were evidently originally separate prophecies. Verses 1-4 are particularly ironic.

17:1 The indictment against Judah for her deeply ingrained sins was written permanently on the people's hearts (cf. Job 19:24). It stood etched there and, also figuratively, on their most prominent places of worship, the pagan altars throughout the land. Sins engraved on the heart pictures the chief characteristic that marked the inner life of the people, which was indelible sin. When Yahweh had given Israel the covenant at Mount Sinai, He inscribed it on tablets of stone (Exod. 24:12; 31:18). But now what was authoritative for the people was sin that they had inscribed on tablets of flesh.

Rather than blood on the horns of the brazen altar in the temple courtyard testifying to the people's commitment to Him, the Lord saw their sins marking the horns of their pagan altars (cf. 7:21-26; Amos 4:4-5). The brazen altar was a place of sacrifice where their sins could be removed, but the horns of their altars had become places of sacrilege where their sins stood recorded.

". . . the people's heart has guilt not only written all over it  
but etched into it, engraved . . . beyond erasure."<sup>278</sup>

In the future God promised to write His law on His people's hearts (31:31-34), but until then their sins were what marked their hearts. Then He would remember their sins no more, but now they remained recorded and unforgiven.

17:2 The people of Judah thought of their idols as frequently and as lovingly as they thought of their children.<sup>279</sup> They mixed the worship of pagan deities with their worship of Yahweh and even gave those gods credit for what belonged to the Lord. Instead of worshipping on high hills where pagan

---

<sup>278</sup>Kidner, p. 71.

<sup>279</sup>Another interpretation, reflected in the NIV, understands the verse to be saying that the parents had so steeped their children in idolatry that their desire for it would emerge at the slightest provocation.

altars stood, the Judahites were to worship on the holy hill where the temple stood.

- 17:3 Jerusalem stood like a mountain surrounded by countryside. Normally a city on such a site would be secure from invaders. But Yahweh would turn over His people's wealth and treasures, and their pagan places of worship (really sin), to their enemy (cf. 15:13). The idolaters thought the places where their shrines stood belonged to the gods they worshipped there, but Yahweh really owned them and would turn them over to Judah's invader.
- 17:4 The Judeans would voluntarily let the inheritance that God had given them, namely, their land, drop into their enemy's hands (cf. 15:14; 2 Kings 25:13-17). They would serve this enemy in a strange land because they had aroused the Lord's anger by their sin.

"The irony is clear: Judah has forsaken or abandoned her covenantal inheritance. Therefore Yahweh will abandon Judah to her enemies, and she will find herself exiled from her inheritance in a land that she had not known."<sup>280</sup>

Verses 5-8 seem to be proverbs that the writer grouped to make his own point. They contrast the wickedness of trusting man with the blessedness of trusting God.

- 17:5 Yahweh announced a curse on anyone who trusts in flesh (humanity in its frailty) rather than in Him (cf. 2:18; Isa. 31:3). While this announcement has universal scope, in this context Jeremiah applied it to the covenant people especially. Judah had trusted in people rather than in Yahweh. Turning away from Him (abandoning His covenant) brought His curse.
- 17:6 The person who would trust in man rather than in God would experience a dry, unproductive, and lonely existence (cf. Ps. 1:4), like the dwarf juniper of the desert. Salty land lacked fertility and life, as is observable to this day around the Dead Sea. Of course, such people may flourish for a season (cf. 12:1-2), but over a lifetime they normally wither.
- 17:7 The Lord also announced a blessing on anyone who trusts in Him, namely, all who acknowledge Him as their Lord and surrender to Him.
- 17:8 Such a person would experience a constantly growing and fruitful life. He or she would enjoy stability, confidence, mental health, freedom from anxiety even in trying times, and a consistently radiant testimony before others (cf. Ps. 1:3). An essential difference between a bush and a tree is its root system. A tree can outlast a drought and continue to bear fruit whereas a bush cannot (cf. Matt. 13:6, 21).

---

<sup>280</sup>Joel F. Drinkard Jr., *Jeremiah 1—25*, p. 224. Drinkard wrote the commentary on chapters 17—25 in this volume of the Word Biblical Commentary, which is listed under Craigie, et al., in the bibliography.

"These verses are a reflection of Jeremiah's own experience. He had known the drought experience when Yahweh seemed to him like a deceitful brook, like waters that failed when sought by a thirsty man (15:18). . . . In 17:5-8 we see a man who has repented from foolish thoughts of despair and consternation before the powerful pressure of public opinion. He had learned to trust Yahweh rather than the opinions of men. The present passage is to be understood as his personal affirmation that he has survived his dry period. Indeed these verses constitute a response to Yahweh's call to repentance in 15:19-21."<sup>281</sup>

Verses 9-11 also appear to have been well-known proverbs that Jeremiah used for his own purposes. Many scholars classify this passage as one of Jeremiah's "confessions."

"If there is such blessing in trusting God, then why do people so generally depend on their fellow humans? Why is it that the blessed are not more numerous than the cursed? The answer lies in the innate depravity of the human heart (v. 9)."<sup>282</sup>

17:9           The Old Testament frequently uses "heart" (Heb. *leb*) to identify the source of a person's thinking and acting. It describes the root of unconscious as well as conscious motivation.

The human heart is deceptive; we may think we know why we do something, but really we may be doing it for another reason. It is naturally sick, really totally depraved, and in need of healing. No one really understands his or her own heart, nor do we understand why our hearts behave as they do.

"Unregenerate human nature is in a desperate condition without divine grace . . ."<sup>283</sup>

17:10          Even though we cannot understand our hearts, the Lord searches them and knows our inner thoughts and motives.<sup>284</sup> He gives to each person what he or she really deserves. He judges on the basis of works because what we do reflects what we really value, the condition of our hearts.

17:11          It is possible to earn a fortune unjustly, like a partridge (or grouse, Heb. *gore'*) that incubates the eggs of another bird.<sup>285</sup> But such a fortune is

---

<sup>281</sup>Thompson, pp. 420-21.

<sup>282</sup>Feinberg, p. 486.

<sup>283</sup>Harrison, *Jeremiah and . . .*, p. 106.

<sup>284</sup>"Heart" and "mind" (lit. kidneys, from the Heb. *kelayoth*, meaning "hidden depths") are not that distinct in Old Testament psychology; they are virtually synonymous here and in many other places. Together these terms cover the range of hidden elements in human character and personality.

<sup>285</sup>Another translation has the partridge brooding over eggs that will not hatch. They become the object of some tragedy that strikes the eggs, such as a predator. See Drinkard, pp. 228-29.



fleeting (cf. Prov. 23:4-5), and such a person is really a fool. The adopted baby bird will fly away when it eventually learns that it is different from its foster parent. Similarly ill-gotten wealth normally leaves the one who does not earn it, and the person who tries to claim that he did earn it ends up looking like a fool (cf. Luke 12:20-21).

Dwelling on the sinfulness of people and the deceitfulness of the heart needs balancing with even greater attention to the glory of God Himself. Jeremiah changed his perspective and so avoided more discouragement.

17:12           The true place of worship for God's people since Solomon had always been the temple in Jerusalem. The ancients regarded this temple as Yahweh's throne on earth.

17:13           This had been true because Yahweh Himself was the hope of His people (cf. 14:8; 50:7). Consequently all who break covenant and forsake Him, the fountain of living water (2:13), will suffer humiliation and will become the objects of His judgment. The Lord keeps a record of those who turn away from Him (cf. v. 1).

Verses 14-18 are another of Jeremiah's "confessions." The guilt of Judah is prominent in the first part of this chapter, but now the innocence of Jeremiah presents a contrast.

17:14           The prophet prayed to Yahweh, the one he praised, for healing and deliverance. Earlier he had spoken of his pain that refused healing (15:18).

17:15           The Judahites kept asking Jeremiah for evidence that what he was predicting would happen. They implied that because his prophecies had not yet materialized they would not.

17:16           Jeremiah vindicated himself by citing three things. He knew that the Lord understood that he was not eager to escape his calling, he did not enjoy announcing judgment, and his messages had not come from his own mind but from the Lord (cf. 2 Pet. 1:21).

17:17           Since Yahweh was Jeremiah's refuge from criticism and discouragement, the prophet asked Him not to frighten him (by appearing to desert him). Jeremiah was not always so trusting (cf. 20:7-12).

17:18           He prayed for God to humiliate his persecutors but not to humiliate him (cf. 1:17). He asked that the Lord would punish them severely for their apostasy (cf. v. 4; 16:18; 20:12; Ps. 17:1-8).

### **The importance of Sabbath observance 17:19-27**

This section contains one of Jeremiah's sermons. Notice its introduction, proclamation of the law, promise of blessing for the obedient, and threat of judgment for the disobedient.

- 17:19-20 The Lord commanded Jeremiah to station himself at the gates of Jerusalem, where the king and the people passed by. It seems impossible to determine which of the gates of Jerusalem was the so-called public gate. He was to call the kings and people to listen to the Lord's message that he had for them. If chapter 7 records his temple sermon, one might regard this as his gate sermon.
- 17:21-22 The Lord commanded His people to observe the Sabbath Day as the Mosaic Covenant specified. They were to refrain from carrying loads in and out of their houses or the city or doing any work (Exod. 20:8-11; 23:15; 31:13-17; Deut. 5:12-15; Neh. 13:15-22; Amos 8:5).
- 17:23 The Judahites forefathers had not obeyed this commandment but had become obstinate and refused to listen to the Lord and to take correction. The Pharisees of Jesus' day went to the other extreme and permitted almost no activity on the Sabbath Day, for which He rebuked them.
- 17:24-25 The Lord promised that if the people of Jeremiah's day obeyed He would give them more Davidic kings and officials who would inhabit Jerusalem and be strong leaders of the people. The city would then enjoy inhabitants forever rather than experiencing total abandonment by the Lord (cf. Isa. 58:1-14; Zech. 2:2-12; 8:3, 15; 14:11). Security depended on obedience, and repentance was still possible.
- 17:26 The Judahites would then return to Jerusalem from all parts of the country. They would bring many different sacrifices to offer to the Lord at the temple.
- 17:27 However, if the people did not observe the Sabbath Day to keep it holy (different from the other days), the Lord would consume Jerusalem with unquenchable fire. Notice the prominence in these promises and threats of the throne of David, the temple, and the city of Jerusalem. These comprised the basic elements of the national and religious life of the covenant people.

It was not just the fourth commandment that the people were responsible to keep, of course. Jeremiah might have chosen to preach on any of the other nine commandments, and he may have done so at other times. This message is probably representative of many similar sermons that the prophet delivered calling the people back to obedience to the covenant. It was repentance that would postpone judgment, not just obedience to the fourth commandment. Yet the fourth commandment had special significance. Sabbath observance recognized Yahweh as Creator and Redeemer, and so witnessed against idolatry. It guaranteed God's people rest, which they could not obtain from idols. And it was one of the unique features of Israel's religion since it marked the special covenant relationship between Yahweh and Israel.

#### **The lesson of the potter's vessel 18:1-12**

There are indications in this message that God might yet avert judgment (vv. 7-8, 11), so Jeremiah evidently delivered it before the Babylonians invaded Judah.

- 18:1-2 The Lord told Jeremiah to go to the potter's house where He would give him further instructions.
- 18:3-4 The prophet observed the potter making a vessel on his wheel. As he worked the vessel became damaged, so he made it into a different vessel. Ancient potter's wheels consisted to two disc-like stones with a connecting vertical axle. The potter spun the one below by kicking it with his feet, and the stone on top served as a rotating table on which he formed his art (cf. Eccles. 38:29-30).<sup>286</sup>
- 18:5-6 The Lord's message to Jeremiah for the nation was that He had the right to deal with Judah as the potter dealt with his clay (cf. Rom. 9:20-21). Judah was like clay in Yahweh's hands. Yahweh was also like a potter (Heb. *yoser*) in that He created and shaped (Heb. *yasar*) His people.
- 18:7-8 The Lord might purpose to destroy Judah, but if the people changed by repenting He could change His mind concerning how He would deal with it.<sup>287</sup>
- 18:9-10 Conversely if He purposed to bless a nation and then it did evil and was disobedient to Him, He could change His mind and not bless it.<sup>288</sup> The character of the clay determined to some extent what the potter would do with it. People who broke the covenant and rejected Yahweh's sovereignty over them were not material through which He would fulfill His purposes.

"The principle is simply the working out of covenant stipulations. Treaties and covenants regularly included conditions for the covenant. For the keeping of covenant, the lord promises blessings on the vassal; but for breaking covenant, the lord promises punishment for the vassal. What was true in the political arena was also true for God and his relationship with his creation. The closest biblical parallel to a working out of this principle is the case of the Ninevites in the Book of Jonah."<sup>289</sup>

"This is a statement of first-class importance for our understanding of all prophecy, removing it entirely from the realm of fatalism. However stark the prediction (except

---

<sup>286</sup>See R. H. Johnston, "The Biblical Potter," *Biblical Archaeologist* 37:4 (1974):86-106.

<sup>287</sup>The Lord has done this with countless individuals throughout history when they turned to Him in faith (e.g., Ruth, Simon Peter, Saul of Tarsus).

<sup>288</sup>God does not repent as humans do, but He does relent. That is, He does not abandon evil ways for good ways, nor does He change His mind about everything, but He does become less severe (or more severe) in dealing with people. See Thomas L. Constable, *Talking to God: What the Bible Teaches about Prayer*, pp. 149-52.

<sup>289</sup>Drinkard, p. 245.

where God has expressly declared it irreversible), it is always open to revision . . ."290

18:11 The Lord told Jeremiah to tell the people that He was planning to bring calamity on them and that they should repent.

18:12 However, the people would respond that repentance would not bring any change. The situation was hopeless from their viewpoint. Really they did not want to change.

"Here is a sad reflection on the end result of evil-doing and of continuous breach of covenant. A state is reached where all desire and hope of repentance is lost and men are content to follow the uninhibited promptings of their own rebellious and wicked hearts. At this point judgment is inevitable."<sup>291</sup>

### **Israel's unnatural behavior and its consequences 18:13-17**

In this message Jeremiah contrasted the unnatural apostasy of the people with the constancy of nature (cf. 2:10-13).

18:13 Yahweh indicted the people of Judah through His prophet asking if any other nation had ever done what Israel had done. As a virgin she had done something appalling. She had polluted herself with the practices of pagan religion including sexual immorality. She had played the harlot.

18:14 Israel's conduct was unnatural, contrary to nature. Jeremiah cited examples of how nature behaves. The snow perpetually covered the Lebanon mountains to Israel's north. For there to be no snow would be unnatural. And cold water ceaselessly flowed from those same mountains (cf. 2:13; 15:18).<sup>292</sup> The headwaters of the Jordan River are four springs that well up near the base of Mount Hermon, which is in the Lebanon range, and they never run dry.

18:15 Israel had abandoned Yahweh and had worshipped worthless idols instead. His people had stumbled off the safe, well-established highway of God's will that she had been traveling and had turned aside to walk in pathways that were no roads (cf. 6:16).

18:16 This action would result in their land becoming desolate. Onlookers and passersby would whistle to themselves in amazement over its terrible

---

<sup>290</sup>Kidner, pp. 76-77.

<sup>291</sup>Thompson, pp. 435-36.

<sup>292</sup>Another possible reading of the first illustration is that Palestinian fields always have rocks in them.

condition and shake their heads in astonishment at what had happened to it because of Israel's stupidity.

- 18:17 Yahweh would scatter His people from their land before the enemy as when the strong east wind (the sirocco, cf. 4:11; 13:34) blew in the windy months. Their enemy would also come from the east, specifically Babylon, though the soldiers would descend on them from the north. Yahweh would turn His back on His people when this calamity fell; He would offer them no help or favor (cf. 2:27; Num. 6:24-26).

### **Jeremiah's reaction to a plot against his life 18:18-23**

This is another section that contains one of Jeremiah's "confessions." Evidently there were several separate plots against the prophet's life (cf. 11:18-23; 12:1-6). People hated him because he brought bad news and called them to repent and to return to Yahweh and His covenant, which most of the people did not want to do. But really the people were rejecting Yahweh (cf. 1 Sam. 8:7).

- 18:18 Some of the Judahites plotted to kill Jeremiah. They justified their action by noting that even if they killed him, the Mosaic Law and the counsel of other wise men and other prophets would still remain. Thus they rationalized their sin.

"The proverb suggests that nothing can shut up a prophet—he always has a word (the last word?)."<sup>293</sup>

They did not believe that their lives would change radically because of their failure to repent. They did not really believe that they were heading for exile. They believed Jeremiah's prophecies were false.

"To disturb a complacent leadership or a misguided populace was only to invite serious repercussions. Human society in every age bears eloquent testimony to the fact."<sup>294</sup>

- 18:19 Jeremiah became aware of the plot and went to the Lord in prayer about it. He asked God to listen to him and to what his opponents were saying (cf. 11:18-20).
- 18:20 Would Yahweh allow evil to come to him since he had done good to these opponents but telling them what was good for them? He had urged them to repent with the promise that they could avoid calamity by turning back to the Lord.

---

<sup>293</sup>Drinkard, p. 253.

<sup>294</sup>Thompson, p. 441.

- 18:21-22 The prophet asked the Lord to bring calamity on them for calamity they planned to bring on him. Since they refused to repent and had tried to kill Yahweh's messenger, let the invasion and all its horrors overtake them. Jeremiah was not requesting some special visitation of judgment on the people. He was asking the Lord to allow the threatened judgment, which he had been urging the people to avoid by repenting, to descend. They refused to repent. His strong request did not spring from wounded pride as much as from his identification with Yahweh and the demands of the covenant (cf. Lev. 26; Deut. 28). The Judahites had rejected God, and for this they deserved judgment.
- 18:23 The Lord knew all that they were planning. Jeremiah believed that He should not forgive them but allow them to experience God's anger in the coming invasion.

What Scripture commands us elsewhere regarding loving and blessing our neighbors rather than cursing them does not contradict Jeremiah's practice here (cf. Prov. 25:21-22; Matt. 5:44; Rom. 12:20). While his motivation may have been wrong—we cannot evaluate that—what he said was appropriate. He was really asking God to fulfill His promise to curse those who departed from His covenant in the ways the Lord had said He would.

"If Jeremiah seems too angry to us, perhaps some of us today aren't angry enough at the evil in this world. Thanks to the media, we're exposed to so much violence and sin that we tend to accept it as a normal part of life and want to do nothing about it. Crusading has given way to compromising, and it isn't 'politically correct' to be dogmatic or critical of ideas that are definitely unbiblical."<sup>295</sup>

### **The broken jar object lesson 19:1—20:6**

This message to the people involved another symbolic act (cf. 13:1-11). This incident may have occurred between 609 and 605 B.C.

"In ch. 18 God explains to Jeremiah that sovereign grace is able to take the marred vessel (Israel) and remake it a vessel of usefulness (v. 4). But to the elders, in ch. 19, the prophet declares that their generation will be irreparably destroyed like a smashed fragile vessel, and the fragments taken to Babylon. That generation of the nation was not restored to the land (19:10-13)."<sup>296</sup>

- 19:1 Yahweh told Jeremiah to take some of Judah's elders and senior priests and to go and purchase a potter's earthenware water-jar (Heb. *baqbuq*).<sup>297</sup>

<sup>295</sup>Wiersbe, pp. 105-6.

<sup>296</sup>*The New Scofield Reference Bible*, p. 789.

<sup>297</sup>The Hebrew word is onomatopoeic suggesting the sound the water made as it poured out of the bottle.

These jars, which archaeologists have found in abundance, range in size from four to 10 inches in height, and they have very slim necks.<sup>298</sup> Perhaps these leaders were willing to accompany Jeremiah, even though he was very unpopular (cf. 20:1-2, 10; et al.), because they wanted to gather incriminating evidence against him.

- 19:2 The prophet was then to go to the section of the Hinnom Valley just south of Jerusalem that was near the Potsherd Gate and deliver the message that the Lord would give him. The Potsherd Gate seems to have been another name for the Dung Gate, which was one of the southern gates to the city leading into the Hinnom Valley below (cf. Neh. 2:13; 3:13-14; 12:31). Evidently people disposed of their broken pottery and other refuse outside this gate.
- 19:3 The prophet was to call everyone in Jerusalem to hear the Lord's message, from the kings to the ordinary citizens. Israel's God, Almighty Yahweh, was about to bring a calamity of unheard of severity on Jerusalem (cf. 1 Sam. 3:11; 2 Kings 21:12).
- 19:4-5 The calamity would come because the people had forsaken Yahweh and had turned the valley of Hinnom, and all Jerusalem (cf. 2 Kings 21:12), into a place of heathen worship, including child sacrifice (cf. 7:31). Their forefathers did not do this, and Yahweh had never commanded these atrocities.
- 19:6 Because of these sins, the Lord predicted that the place would receive a new name: the valley of Slaughter. Its previous names were the valley of the Son of Hinnom and Topheth (lit. fireplace or hearth; cf. 7:31-32; Isa. 30:33). A change of name in the Old Testament frequently signified a change of function (cf. Gen. 17:5, 15; et al.).
- 19:7 The Lord would also turn the wise advice of the people of Judah and Jerusalem into foolishness. As they had worshipped nothings there, so their wisdom would come to nothing. Their enemy would also defeat and slaughter them there, as they had slaughtered their innocent children. No one would bury their dead bodies, but they would become food for carrion birds and wild beasts since they had slain similar animals to worship the idols (cf. 7:33; 16:4; 34:20; Deut. 28:26).
- 19:8 Yahweh would also destroy Jerusalem so that everyone who passed its ruins would whistle in amazement because of the devastation (cf. 18:16; 1 Kings 9:8; Lam. 2:15-16; Ezek. 27:36; Zeph. 2:15).
- 19:9 The siege of Jerusalem would be so bad that the residents would eat their own children and one another rather than die of starvation (cf. 11:1-8; Lev.

---

<sup>298</sup>Feinberg, p. 495.

26:29; Deut. 28:53-57; 2 Kings 6:26-29; Lam. 2:20; 4:10). This was compensation for their having taken human life to worship pagan idols. Being consumed by cannibals was a typical curse for treaty-breakers in the ancient Near East, as was lack of burial (v. 7).<sup>299</sup>

19:10-11 Jeremiah was to break his jar in the sight of his hearers as a symbolic act and was to announce that just so the Lord would destroy the people and the city. They would not be able to recover from this catastrophe any more than one could repair a shattered earthenware jar. The only burial places would be in Topheth. The "fireplace" would become a cemetery.

Earlier the Lord implied that He would reshape the nation if the people repented, as a potter reshapes a vessel under construction on the wheel (18:1-2). But now Judah was a hardened vessel incapable of changing. All the Lord could do with it now was break it.

"If there is nothing so workable as a clay pot in the making,  
there is nothing so unalterable as the finished article."<sup>300</sup>

19:12-13 Yahweh would make Jerusalem a place of fire and its people a sacrifice, too, because all the people, from the ordinary citizens to the kings, had turned their houses into altars to pagan gods. The presence of corpses would make the city unclean. The people had offered burnt offerings and poured out drink offerings on their flat rooftops to astral deities and other idols (cf. 7:16-20; 32:29; Zeph. 1:5). Archaeologists have discovered cuneiform texts at Ras Shamra (east of Cyprus on the west coast of Syria) that contain instructions for offering sacrifices to astral gods on flat rooftops.<sup>301</sup>

19:14-15 Jeremiah then returned from Topheth in the valley of Hinnom to the temple courtyard. There he preached to the people that the Lord was about to bring this calamity on Jerusalem and the towns of Judah because they had stubbornly refused to repent (cf. Acts 7:51).

20:1-2 When Pashhur, who was the leading priest responsible for the oversight of the temple, heard Jeremiah's words, he ordered him beaten and imprisoned in stocks that stood near the Benjamin Gate. This gate was evidently the new gate into the inner temple courtyard that King Jotham had constructed (cf. 2 Kings 15:35). It provided an entrance from the north, in which direction the tribal territory of Benjamin lay. Consequently many people would have seen Jeremiah there.

---

<sup>299</sup>See D. R. Hillers, *Treaty-Curses and the Old Testament Prophets*, pp. 62-63, 68-69.

<sup>300</sup>Kidner, p. 78.

<sup>301</sup>Harrison, *Jeremiah and . . .*, p. 112.



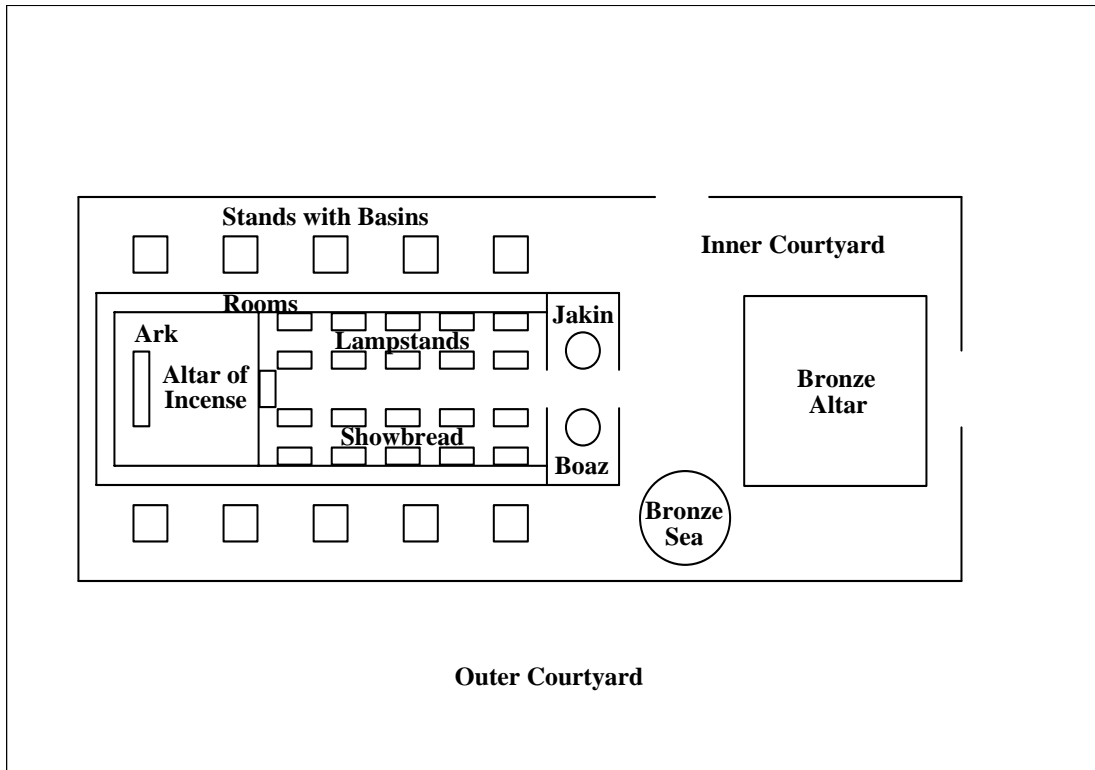

### SOLOMON'S TEMPLE

"The 'stocks,' where the prophet was confined, were intended not only for restraint but also for torture. The stocks, which were used for false prophets (cf. 2 Chron 16:10), held the feet, hands, and neck so that the body was almost doubled up (cf. 29:26). The Hebrew word for 'stocks' (*mahpeketh*) means 'causing distortion.'"<sup>302</sup>

Ironically, this overseer in God's temple, evidently the man in charge of preserving order in the courtyard, was taking action against God's overseer of the nations, Jeremiah (cf. 1:10). This is the first recorded act of violence done to Jeremiah. It reminds us of the captain of the temple guard who, years later, similarly imprisoned Peter and John (Acts 4:1-3).

20:3 Jeremiah's confinement only lasted one day. Following his release, the prophet gave Pashhur a new name that had prophetic significance: Magomassabib, meaning "terror on every side" (cf. 6:25; Ps. 31:13).<sup>303</sup>

<sup>302</sup>Feinberg, p. 500. See also *The Interpreter's Dictionary of the Bible*, s.v. "Stocks," by M. Greenberg, 4:443.

<sup>303</sup>His old name means either "ease" or "tranquility." Perhaps this name reflected his natural disposition.

- 20:4 The Lord announced through Jeremiah that Pashhur would become a terror to others, his friends, and even himself, and he would feel terror when he saw the coming invader slaughter his loved ones. The Lord promised to deliver all Judah over to the Babylonian king who would take many of the people captive to Babylon and slay them with the sword. This is the first explicit reference to the place of exile in the book (cf. 1:13; 15:14).
- 20:5 Likewise the enemy would take all the wealth and even the royal treasures of Jerusalem to Babylon. In other words, the enemy would plunder the temple and the royal palaces.
- 20:6 Pashhur himself, as well as his loved ones, would end up in Babylon as exiles. Evidently he went into captivity in 597 B.C. since another man, Zephaniah, occupied his office after that date (cf. 29:24, 26, 29). He, and all who had gathered around him as his disciples, would die and be buried there because he had prophesied falsely concerning the coming invasion. Like Jeremiah, Pashhur was both a priest and a prophet.<sup>304</sup>

"Pashhur, who would terrorize Jeremiah for the message he proclaimed, will be terrorized and will become a terror for all to witness, as will all Judah (vv 4-5). Just as the people of Jerusalem and Judah would die at the hands of their enemies (19:7), so Pashhur would die. Only he would die and be buried in a foreign land."<sup>305</sup>

### **Jeremiah's struggle with his calling 20:7-13**

This section is another of Jeremiah's autobiographical "confessions." In literary form it is another individual lament, like many of the psalms (cf. Ps. 6). It is one of Jeremiah's most significant self-disclosures. The section has two parts: God the antagonist (vv. 7-10), and God the protagonist (vv. 11-13).

- 20:7 The prophet complained that the Lord had deceived him (cf. Exod. 22:16; 1 Kings 22:20-22) and had overcome him. He had made Jeremiah a laughingstock and an object of constant mockery by his people. Evidently Jeremiah hoped that the people would repent at his preaching, and when they did not he felt betrayed by the Lord.
- 20:8 Jeremiah felt that he was always shouting messages of impending disaster, and these announcements had resulted in people criticizing and ridiculing him constantly.

---

<sup>304</sup>Jeremiah, as far as we know, never served as a priest, however.

<sup>305</sup>Drinkard, p. 268.

- 20:9 When Jeremiah became so tired of the opposition he faced that he decided to stop delivering his messages, the Lord's word burned within him as a fire. Finally he could contain himself no longer and spoke again.<sup>306</sup>
- 20:10 The prophet knew that the people were complaining that all he ever talked about was coming terror. He had become a "Magomassabib" of sorts himself (cf. v. 3), and the people may well have applied this nickname to him. They felt someone should denounce him for speaking so pessimistically and harshly about their nation. Even his trusted friends had turned against him and were hoping that he would make some mistake so they could discredit him for his words. The Lord Jesus Christ suffered similar opposition (cf. Mark 3:2; 14:58; Luke 6:7; 14:1; 20:20).
- 20:11 Yet Jeremiah was confident that the Lord would remain with him and defend him like a powerful bodyguard (cf. 1:18; 15:20). Consequently his persecutors among the people of Judah would not succeed. They were the ones who would stumble, feel ashamed, and experience everlasting disgrace, not him (cf. v. 10).
- 20:12 The prophet asked the Lord to allow him to witness the humiliation of his critics since he was entrusting vengeance to Him and not taking it himself. Yahweh knew the hearts and minds of both Jeremiah and his persecutors, so the Lord knew who was right and who was wrong.
- 20:13 The prophet closed this lament with a call to praise the Lord in song because He had delivered Jeremiah from those who wanted to do him evil.

### **Jeremiah's deep despair 20:14-18**

This is another autobiographical "confession." It is a personal lament or curse poem concerning the sorrow Jeremiah had experienced for most of his life because of the calling that the Lord had laid on him.

"In these verses Jeremiah plumbed the depths of bitterness and despair, revealing a depth of misery and agony surpassing any other cry of anguish recorded among his lamentations."<sup>307</sup>

- 20:14 Again Jeremiah cursed the day of his birth; he felt bitterly sorry that he had ever been born (cf. 15:10; Job 3:3-6).<sup>308</sup> He meant that his birth occurred on a day that God had cursed, and that accounted for his misfortune.

<sup>306</sup>One writer, Fred M. Wood, used this apt description of the prophet's feelings as the title of his book on Jeremiah, *Fire in My Bones*.

<sup>307</sup>Thompson, p. 463.

<sup>308</sup>Cursing one's parents was a capital offense under the Mosaic Law (Lev. 20:9; 24:10-16), but Jeremiah did not do that.

- 20:15 Jeremiah felt that it would have been better if his father had never received the news that he had a baby boy. Normally the birth of a male child was the best news a man could receive since the birth of a boy usually guaranteed the perpetuation of his family line. Jeremiah was similar to that messenger in that he thought he was bringing good news of escape from divine deliverance to the nation, but it turned out to be bad news of distress and battle cries.<sup>309</sup>
- 20:16-17 The messenger of Jeremiah's birth would have been better off, from the prophet's perspective, if he had been slain by the Lord, as when the Lord overthrew Sodom and Gomorrah (Gen. 19). He would have been well advised to run for cover on that day. The messenger was the object of Jeremiah's curse because the prophet wished the Lord had slain him in his mother's womb rather than bringing him to birth.
- 20:18 Jeremiah bewailed the fact that he ever came out of his mother's womb since his life had been so full of trouble, sorrow, and shame.<sup>310</sup>

"What these curses convey . . . is a state of mind, not a prosaic plea. The heightened language is not there to be analysed [*sic*]: it is there to bowl us over. Together with other tortured cries from him and his fellow sufferers, these raw wounds in Scripture remain lest we forget the sharpness of the age-long struggle, or the frailty of the finest overcomers."<sup>311</sup>

"Jeremiah was discouraged because he was a man standing against a flood. And I want to say to you that nobody who is fighting the battle in our own generation can float on a Beauty Rest mattress. If you love God and love men and have compassion for them, you will pay a real price psychologically. . . .

"But what does God expect of Jeremiah? What does God expect of every man who preaches into a lost age like ours? I'll tell you what God expects. He simply expects a man to go right on. He doesn't scold a man for being tired, but neither does He expect him to stop his message because people are against him."<sup>312</sup>

### **A collection of Jeremiah's denunciations of Judah's kings and false prophets chs. 21—23**

This section of the book contains some of Jeremiah's messages concerning Judah's kings (21:1—23:8) and false prophets (23:9-40) that he delivered closer to the time of

---

<sup>309</sup>Drinkard, p. 279.

<sup>310</sup>Verses 17-18 are another indication that human life exists in a mother's womb before birth. Jeremiah existed as a person in his mother's womb.

<sup>311</sup>Kidner, p. 81.

<sup>312</sup>Schaeffer, pp. 69-70.

Jerusalem's invasion than the previous chapters.<sup>313</sup> Beginning with chapter 21, there are many more specific references to people, places, and time than we find in chapters 1—20. The prophecies announcing judgments on the kings (chs. 21—22) close with a message of hope concerning the future (23:1-8).

### **Zedekiah's request and Jeremiah's response 21:1-10**

This passage probably dates from the Babylonian siege of Jerusalem in 588-586 B.C. (vv. 2, 4; cf. 2 Kings 25). King Zedekiah sought advice from Jeremiah more than once (cf. 37:3-10, 17-21; 38:14-28). This passage consists of two oracles (vv. 1-7 and 8-10).

- 21:1 This is a message that Yahweh gave Jeremiah after King Zedekiah sent messengers to him with a question. The messengers were Pashhur (cf. 38:1-13; 1 Chron. 9:21; not the man in charge of preserving order in the temple courtyard mentioned in 20:1-6) and Zephaniah, a leading priest (cf. 29:25-26, 29; 37:3; 52:24; 2 Kings 25:18-21).
- 21:2 Zedekiah asked Jeremiah to inquire of the Lord whether He would give Judah deliverance from Nebuchadnezzar as He had delivered His people in the past.<sup>314</sup> Zedekiah may have been hoping for a miraculous deliverance such as Jehoshaphat experienced from the Moabites, Ammonites, and Meunites (2 Chron. 20). Hezekiah had also experienced supernatural deliverance when Sennacherib besieged Jerusalem (2 Kings 19; Isa. 37).
- 21:3-4 Jeremiah sent a message from the Lord back to the king through his messengers. The weapons of the defenders of Jerusalem would be ineffective. The Chaldean soldiers who were then besieging the city's walls would penetrate it and enter the center of Jerusalem.

The Babylonians (Chaldeans) were originally a seminomadic tribe living between northern Arabia and the Persian Gulf. In the tenth century B.C., the Assyrians gave the name *Kaldu* to the area formerly known as the 'Sea-Land' [i.e., Mesopotamia]. . . Later, 'Chaldea' was used to include Babylonia as a whole (cf. Ezek 23:23; Dan 3:8)."<sup>315</sup>

<sup>313</sup>See the chart and discussion of Judah's last five kings under the historical background comments in the Introduction section of these notes.

<sup>314</sup>King Hezekiah had sent a similar group to Isaiah inquiring about the approaching Assyrian army (2 Kings 19:2; Isa. 37:2). Nebuchadnezzar, sometimes referred to as Nebuchadrezzar (the spelling nearer to the Babylonian form of his name), ruled Babylon from 605-562 B.C. He succeeded his father, Nabopolassar, the first king of the Neo-Babylonian empire, who ruled from 626-605 B.C. This is the first reference to Nebuchadnezzar in Jeremiah.

<sup>315</sup>Feinberg, p. 507. See also *The New Bible Dictionary*, 1962 ed., s.v. "Chaldaeae, Chaldeans," by D. J. Wiseman, pp. 203-4.

- 21:5-6 The Lord promised that not only the Babylonians but He, too, would fight against the city. He would bring His strong arm against Jerusalem in anger and would strike down its inhabitants (cf. Deut. 4:34; et al.). Normally the Divine Warrior fought *for* His people, but now He would fight *against* them. Humans and animals would die from the sword and from diseases, a curse for breaking covenant (cf. 14:12; 32:24; Exod. 5:3; 9:15; Num. 14:12).
- 21:7 Nebuchadnezzar would also slay King Zedekiah, his servants, and the people who survived the war and its accompanying famine and diseases. The Babylonian king would show no mercy or compassion. Zedekiah did indeed die in Babylon, some time after the Babylonians killed his sons as he watched and then blinded him (34:4; 52:11; 2 Kings 25:6-7; Ezek. 12:13).

Jeremiah directed this second oracle against the people of Jerusalem.

- 21:8 The prophet also received another message from the Lord. Yahweh was going to give the people the choice of living or dying (cf. Deut. 30:15, 19; Matt. 7:13-14).
- 21:9 If the residents of Jerusalem stayed in the city and resisted the enemy, they would die; but if they surrendered to the Babylonians, they would live.
- 21:10 The Lord's purpose for the city was firm: He would turn it over to the Babylonian army to destroy it by fire. This was something the people could not change by their actions or their prayers.

### **Messages about the duties of the kings of Judah 21:11—22:9**

This group of prophecies begins and ends with oracles concerning the kings' duties (21:11-12; 22:1-9). In the middle is an oracle against Jerusalem (21:13-14).

- 21:11-12 Jeremiah was to tell the king of Judah and his administrators to be careful to dispense justice every day, particularly with the poor and powerless. If they did not, the Lord's wrath would burn against them as an inextinguishable fire (cf. 4:4; 17:4, 27; 21:12, 14; 43:12; 49:27). Normally court convened in the morning to avoid the heat of the day (cf. 2 Sam. 4:5).

"The administration of justice was one of the main duties of kings all over the Near East. The king was the guardian of justice [cf. 2 Sam. 15:4; 1 Kings 3:9, 16-28; 8:32]."<sup>316</sup>

The Lord also sent a message to the residents of Jerusalem.

---

<sup>316</sup>Thompson, pp. 470-71.

21:13 Yahweh was against the people who lived in Jerusalem. Jerusalem stood enthroned on a hilltop with valleys on three of its sides (cf. Ps. 125:2; Isa. 22:1). It stood on a rocky plateau of sorts. Jerusalem's physical location had led its inhabitants to feel secure.

21:14 Nevertheless, the Lord promised to punish the residents for their evil deeds (cf. v. 5). He would kindle a fire in its forest, perhaps a reference to the House of the Forest of Lebanon, one of the palace complex buildings (1 Kings 7:2). The fire would spread to other buildings in Jerusalem.

"Not only will the Divine Warrior fight against them, but also their Dwelling Place will destroy their dwelling places!"<sup>317</sup>

The subject of the next oracle is, again, a Davidic king of Judah, but which one is unknown.

22:1-2 The Lord told Jeremiah to go to the king's palace and deliver a prophetic message to him, his servants, and the people who gathered there.

22:3 Jeremiah called the king and his administrators to practice justice in their decisions regarding civil matters (cf. 21:12). They should protect the weak and vulnerable and should not shed innocent blood. Social justice has always been important to Yahweh.

"Who within our society are represented by the ones robbed by extortioners or by the sojourner, orphan, and widow? Is it the poor, the migrant, the alien? Is it the Third World worker who provides delicacies for our table, or cheap products for our market, but barely ekes out an existence for himself and his family? Is our concern for justice limited to ourselves and those like us? Or do we practice justice even toward those who have no advocate?"<sup>318</sup>

22:4 If they obeyed, God would perpetuate the reign of David's descendants on Judah's throne with glory and power.

22:5 If they disobeyed, God swore by Himself to destroy the palace.

Verses 6 and 7 appear to be another oracle, in poetic form, against an unnamed Judean king.

---

<sup>317</sup>Drinkard, p. 294.

<sup>318</sup>Ibid., p. 299.

- 22:6 The Lord regarded the Davidic palace as a most pleasant and glorious thing, like Gilead and Mount Hermon, areas both famous for their forests and mountains. Again, the House of the Forest of Lebanon may be particularly in view (cf. 21:14). Yet He would turn the king's residence into a desolation, like a wilderness or an uninhabited town, if the rulers disobeyed.
- 22:7 He would appoint destroyers for the royal residence, and the royal line, who would cut the palaces down like a forest of trees (cf. Ps. 74).

This pericope is very similar to the preceding one though in prose.

- 22:8 Representatives from other nations would pass by Jerusalem and wonder why her God had destroyed her (cf. Matt. 23:28; Luke 13:35).
- 22:9 It would become clear to them, on reflection, that it was because the kings and people had broken covenant with Yahweh. Ancient Near Easterners understood the consequences of covenant unfaithfulness, and they would associate them with Jerusalem's fate.

#### **A prophecy about King Jehoahaz (Shallum) 22:10-12**

This section probably contains two originally separate parts (vv. 10 and 11-12).

- 22:10 Jeremiah instructed the people not to mourn over Josiah, who had died in battle with the Egyptians, as much as they should mourn over those who had gone into captivity. Pharaoh Neco II had deposed Jehoahaz and had taken him captive to Egypt (2 Kings 23:31-35).<sup>319</sup> The fate of the people and Jehoahaz was worse than Josiah's because they would remain alive but never be able to return to the Promised Land. In one sense death is worse than life, but in another sense life under certain conditions is worse than death.
- 22:11-12 King Shallum (Jehoahaz) was a case in point. The Egyptians had taken him captive, and he would never return to the Promised Land. Jeremiah prophesied that he would die in captivity, which he did as the first ruler of Judah to die in exile (cf. 2 Kings 23:34).

#### **A prophecy about King Jehoiakim 22:13-19**

"Jehoiakim was condemned by Jeremiah more severely than any other king. He seems to have been a typical Oriental despot who rejected Josiah's reforms."<sup>320</sup>

<sup>319</sup>Jehoahaz was the king's throne name, and Shallum was his personal name. He was Josiah's fourth son whom the people of the land had placed on Judah's throne (2 Chron. 36:1).

<sup>320</sup>Thompson, p. 478.



22:13-14 Jeremiah called down woe on the person who advanced his own interests, and built his own royal house (palace and, by implication, dynasty), by abusing the rights of others (cf. Lev. 19:13; Deut. 24:14; Mal. 3:5).

"This man, who gave his mind to trivialities at a time of crisis, and who saw his subjects only as exploitable, was a vulture at law and a peacock at home."<sup>321</sup>

22:15 The measure of a king's greatness is not really the beauty and cost of his palace but his righteousness and justice. Jehoiakim's father, Josiah, had been a great king, and God had blessed him because he practiced these virtues (cf. John 4:34).

22:16 Josiah had given justice to those who needed it regardless of who they were. By this he demonstrated that he really knew Yahweh. He behaved like Yahweh.

22:17 Jehoiakim had only been interested in acquiring things for himself, even dishonestly. He resorted to oppression, extortion, and even murder to get what he wanted (26:20-23; 2 Kings 24:3-4).

"Jehoiakim, who was only twenty-five years old when he began to reign and only thirty-six when he died (2 K. 23:36), was evidently a thoroughly spoiled and self-indulgent young despot."<sup>322</sup>

22:18 Consequently when Jehoiakim died, people would not feel sorry or mourn over his departure. They would not lament for him or for the splendor he left behind. The Hebrew word *hoy*, usually translated "woe" but here rendered "alas," occurs four times in this verse stressing the dire judgment that would befall this king.

22:19 Rather the people would treat his corpse with great disrespect. They would give him a burial similar to that of a donkey (or Jezebel), which people dragged outside the city gate and left to rot (cf. 36:30; 1 Kings 21:23-24).<sup>323</sup>

Of some people the Bible says nothing bad, but of Jehoiakim it says nothing good.<sup>324</sup>

---

<sup>321</sup>Kidner, p. 87.

<sup>322</sup>Thompson, p. 479.

<sup>323</sup>Flavius Josephus, *Antiquities of the Jews*, 10:6:3, wrote that Nebuchadnezzar had his body thrown before the walls without any burial.

<sup>324</sup>Goddard, p. 100.

### **An oracle of Jerusalem's doom 22:20-23**

- 22:20 The prophet spoke of Jerusalem as a young woman in this oracle. He called on her to go up on the surrounding mountains to bewail the loss of her lovers (political allies and pagan gods). The Lebanon mountains were to Judah's north, Bashan was to the northeast, and the Abarim range was to the east of Jerusalem (cf. Num. 27:12; Deut. 32:49).
- 22:21 When Jerusalem was prosperous, in the days of David and Solomon, the Lord had appealed to the people to obey His covenant, but they would not listen. That had been their practice since early in their history as a nation.
- 22:22 The Lord would remove her nobles and leaders, and all the people she had trusted in to supply her needs would go into captivity. Then Jerusalem would feel ashamed because she had behaved wickedly. This happened in 597 B.C. when Nebuchadnezzar deported many of the nobles (2 Kings 24:22—25:7).
- 22:23 The cedar paneling of the people's houses demonstrated their trust in Lebanon, since it came from there. Their homes were like little nests made of cedar (cf. Ezek. 23:14). In this sense they dwelt in Lebanon, even though their homes were in Jerusalem. Yet these comfortable surroundings would not be able to protect Jerusalem from the pain that was going to come on her, pain as excruciating and inevitable as the agony of childbirth. Jerusalem was a city in the mountain heights enthroned in Lebanon and nested in her cedars, but God would bring her down.

### **Prophecies about King Jehoiachin (Coniah) 22:24-30**

This section contains two prophecies about this king (vv. 24-27 and 28-30). The historical setting is the three-month reign of eighteen-year-old Jehoiachin in 598-597 B.C. (cf. 2 Kings 24:8-17). Coniah was a shortened form of Jehoiachin (cf. 37:10), and another form is Jeconiah (cf. 24:1; 27:20; 28:4; 29:2).

- 22:24 The Lord affirmed that even if Coniah (Jehoiachin) was the signet ring on His hand He would still remove him. The signet ring of a king was something a king did not part with because it was the instrument with which he conducted business and manifested his authority.
- 22:25 Yahweh was going to give Coniah over to King Nebuchadnezzar. The transfer of the signet ring symbolized the transfer of authority. Now Babylon would control the affairs of Judah.
- 22:26-27 But Yahweh would not reluctantly hand over Coniah; He would hurl him into a foreign country where he would die. His mother, the powerful queen mother, Nehushta, would go with him (cf. 13:18; 2 Kings 24:8, 11-12). They would not be able to return to their native land (cf. 52:31-34; 2

Kings 25:27-30). Mordecai and Ezekiel traveled to Babylon in the same group of exiles (Esth. 2:5-7; Ezek. 1:1-2).

- 22:28 Why would Yahweh treat Coniah like a piece of broken pottery that people tossed on the garbage heap? The answer, not given, is that he proved to be an unfaithful servant of the Lord, a covenant-breaker (cf. 19:1-13).
- 22:29 Jeremiah called on the land of Judah to hear a very important prophecy from Yahweh. The threefold repetition of "land" indicates how important it was for the people of the land to listen.
- 22:30 The Lord promised that none of Coniah's sons would sit on Judah's throne. It was a shame and a disgrace for a king to have no son to succeed him. Coniah had seven sons (1 Chron. 3:17-18; Matt. 1:12), but none of them ruled as Davidic kings.<sup>325</sup>

### **Promises about the future of the Davidic line and the people 23:1-8**

"After the oracles against wicked kings, there is a promise of a righteous one, the Shoot of David."<sup>326</sup>

Jeremiah just announced that none of Coniah's descendants would ever rule as kings. Now he went on to clarify that a Davidic king would rule in the future. God was not cutting off the Davidic line (cf. 2 Sam. 7:14). This section consists of three separate though related prophecies (vv. 1-4, 5-6, and 7-8).

- 23:1-2 Yahweh announced coming judgment on the leaders of Judah, kings and other leaders, who were harming His people rather than tending them like good shepherds care for sheep (cf. John 10:11-13). Shepherd was a common figure for king in the ancient Near East and in the Old Testament, and it is possible that Jeremiah had in mind the last four kings of Judah particularly. The figure of God's people being the sheep of His pasture is also common in the Old Testament (cf. Ps. 74:1; 79:13; 95:7; 100:3). Judah's shepherds had not attended (Heb. *paqad*) to the flock, so God would attend (Heb. *paqad*) to punishing them.
- 23:3 After this judgment the Lord Himself would, as a good shepherd, re-gather the remnant of His people that were left from all the countries where He had driven them into exile (cf. 3:16; 24; 31:10; 40—44; Isa. 1:9; 37:4; Mic. 2:12; 4:7; 5:4; 7:14, 18). The Lord was the final cause of the exile, but the shepherds of Judah were the instrumental cause (v. 2). He would bring them back into the Promised Land and cause them to be fruitful and

<sup>325</sup>Zerubbabel, his grandson (1 Chron. 3:19), returned to the land as one of the foremost leaders of the restoration community (cf. Ezra 1—6), but he was not a king.

<sup>326</sup>Graybill, p. 673.

multiply (cf. Gen. 1:22, 28; 9:1; 12:1-3; Exod. 1:7). There is a double contrast in this verse between the Lord and the false shepherds and between their respective works.

The reference to the many countries to which the Lord had driven them suggests an eschatological return to the land that exceeded the return from Babylonian exile.<sup>327</sup>

"History has shown that restoration [from Babylon] to be a temporary flicker of light, for by the time of Malachi (the last of the prophets, ca. 400 B.C.), Israel had degenerated again to a people with stony hearts."<sup>328</sup>

- 23:4 The Lord also promised to raise up shepherds (leaders) for His people then who would care for them properly (cf. 3:15). The Israelites would then no longer feel fearful or terrified, and none of them would be missing from the land.
- 23:5 Yahweh also promised to raise up another Davidic king in the future (cf. Ps. 2; 44; 72; 89—110).<sup>329</sup> He would be as a branch or sprout (Heb. *semah*) that springs up from an apparently dead stump, namely, the Davidic line of kings (cf. 2 Sam. 23:5; Ps. 132:17; Isa. 4:2; 11:1; Zech. 3:8; 6:12). His characteristic marks would be wisdom, justice, and righteousness, traits notably absent from the last of Judah's kings (cf. 22:3). He would be a true shoot (Heb. *semah saddiq*), a "legitimate scion," of David's line.<sup>330</sup> He would rule as a true king, not as a puppet like the last four kings of Judah. This is one of the few direct messianic references in Jeremiah (cf. 3:15-18; 31:31-34; 33:15-16).
- 23:6 During His reign Judah and Israel would experience salvation and security. People would refer to Him as "Yahweh our righteousness." This strongly suggests that the king would be Yahweh Himself ruling in righteousness (cf. 1 Cor. 1:30; 2 Cor. 5:21). His name appears to be a play on the name Zedekiah, which probably means, "Yahweh is my righteousness."<sup>331</sup> Ironically, Zedekiah was anything but righteous.
- 23:7-8 In those coming days (cf. v. 5), people would no longer talk about the mighty deliverance that Yahweh gave His people when He brought them out of Egypt into the Promised Land (cf. 16:14-15). Instead they would

<sup>327</sup>See Feinberg, pp. 517-18.

<sup>328</sup>Jensen, p. 70.

<sup>329</sup>According to Harrison, *Jeremiah and . . .*, p. 119, the clause translated here, "Behold, the days are coming," introduces a message of hope for the future 16 times in Jeremiah.

<sup>330</sup>See J. Swetnam, "Some Observations on the Background of *saddiq* in Jeremias 23:5a," *Biblica* 46:1 (1965):29-40.

<sup>331</sup>If so, this prophecy probably dates from Zedekiah's reign.

talk about the greater deliverance that He gave them when He brought them out of many countries (cf. v. 3; 16:14-18) into the Promised Land (cf. Isa. 11; Ezek. 34; 37).

Again, the promises are clearly eschatological. This will happen at Jesus Christ's second coming when He subdues His earthly enemies and re-gathers the Jews to their land.<sup>332</sup>

The section 21:1—23:8 dealt primarily with oracles against kings. Now the subject becomes the false prophets in Jerusalem (23:9-40).

### **Prophecies about false prophets 23:9-40**

Having given a true prophecy about the future, Jeremiah proceeded to announce God's judgment on the false prophets who were misleading His people with false prophecies (cf. v. 1). This section consists of six different messages that Jeremiah delivered at various times, which the writer placed together in the text because of their common subject (vv. 9-12, 13-15, 16-22, 23-24, 25-32, and 33-40).

The first pericope is a general indictment of the false prophets (vv. 9-12).

- 23:9            Jeremiah had become like a drunken man in that the prophecies God had given him concerning the false prophets sent him reeling. They disturbed his mind deeply and broke his heart. This verse serves as a superscription for the entire series of prophecies about the false prophets that follows in verses 10-40.
- 23:10           The false prophets were unfaithful to the Lord in their attachment to pagan deities. They were off course in their direction, and they were strong only in doing wrong. The evidence of their corruption was the curse that the land was experiencing from departing from the Mosaic Covenant. Baal was supposed to produce fertility, but worshipping him had only resulted in parched and barren land for Judah.
- 23:11           The Lord announced that both prophets and priests were polluted with unfaithfulness. They even practiced their wickedness in the temple, where of all places they should have been faithful to the Lord (cf. 2 Kings 21:3-7; 23:4-7; Ezek. 8).
- 23:12           Therefore the Lord would make them unstable. He would allow them to fall into perilous situations (Ps. 35:6; 73:18) and wander off into obscurity (cf. 13:16). At the proper time He would bring calamity on them.

---

<sup>332</sup>See Kaiser, pp. 108-10. Amillennialists see the fulfillment happening in the return from exile and in the first advent of Christ. Thompson, p. 492, for example, referred to 2 Kings 17:6 as evidence that the exiles went into many countries, but that verse describes cities and lands within the larger territory of Assyria and, later, Babylon.

"... they will be like men sliding on a slippery trail in the darkness, stumbling and falling on top of one another."<sup>333</sup>

"Whenever a nation needs healing, it's usually because God's people aren't obeying and serving Him as they should. We like to blame dishonest politicians and various purveyors of pleasure for a nation's decline in morality, but God blames His own people."<sup>334</sup>

The next prophecy compares the false prophets of the Southern Kingdom to the false prophets in the then defunct Northern Kingdom (vv. 13-15).

23:13 The prophets of Samaria, the capital of the Northern Kingdom, had offended the Lord by prophesying in Baal's name and by leading God's people astray.

23:14 But the prophets of Jerusalem, the capital of the Southern Kingdom, had been even more unfaithful since they prophesied falsely in Yahweh's name. They also committed spiritual (and physical) adultery, lived lies, and encouraged evildoers. Consequently the Judahites had not repented of their wickedness but had become as wicked as the sinners of Sodom and Gomorrah who espoused departure from God's will openly (Gen. 18:22—19:29; Ezek. 16). Jerusalem could expect severe judgment since the Lord had judged these pagan cities severely.

"Along with easy views of sin go rosy views of judgment  
..."<sup>335</sup>

23:15 Almighty Yahweh would make the false prophets experience bitterness and tragedy, as when one eats bitter food and drinks poisoned water (cf. 8:14; 9:15), because they had embittered and poisoned the people. He would pollute them because they polluted the people and the land with their sins.

The following message criticizes the false prophets for delivering unauthorized prophecies as though they came from Yahweh (vv. 16-22).

23:16 The almighty Lord warned His people through Jeremiah not to listen to the false prophets who were leading them into empty hopes. They were claiming that their own invented prophecies came from the Lord, but they were speaking empty words; they were just windbags.

23:17 They were falsely assuring the people, who despised Yahweh and resisted His will, that nothing bad would happen to them. Peace would continue and calamity would never overtake the people, they claimed.

---

<sup>333</sup>Harrison, *Jeremiah and . . .*, p. 121.

<sup>334</sup>Wiersbe, p. 113.

<sup>335</sup>Kidner, p. 91.

23:18 They had not taken counsel from Yahweh nor received His prophetic messages. They had not listened to Him and obeyed Him (cf. Matt. 11:27; John 1:18; 8:38, 40). The picture of the heavenly throne-room of God is common in the Old Testament (e.g., 1 Kings 22:19-22; Job 1:1—2:7; Ps. 82; Isa. 6; Ezek. 1).

"It is a word of judgment and not peace that should be proclaimed by one who really knows the mind of Yahweh. But one needs to stand in Yahweh's council, see what goes on there, hear and pay attention to Yahweh's word and obey it, to give such a word."<sup>336</sup>

23:19-20 The judgment of God would come on the wicked like a whirlwind. He would carry out His purposes fully and not draw back in mercy. When His judgment fell, the wicked would understand it as His judgment. "In the last days" refers to the last days of Jerusalem before its total destruction; this is not an eschatological reference here.<sup>337</sup>

23:21 The Lord had not sent the false prophets or given them messages, but they had claimed to bring prophecies from Him to the people.

"As an analogy in modern terms we could compare the speculations of journalists over some matter of government which is being decided behind closed doors, with the actual announcement entrusted to a spokesman from the conclave itself."<sup>338</sup>

23:22 If they had listened to the Lord, they would have tried to turn the people back from their evil ways.

"How could a prophet confuse his own word with God's word? How could a prophet fail to speak condemnation to the sinful, covenant-breaking situation? Perhaps part of the answer was political and economic. The prophets were often part of the establishment; as such they were concerned with the maintenance of the establishment for their own security and well-being. Another part of the issue may have been purely rationalistic: Yes, some of our folks are sinful, but look at the pagans around us; they don't even worship God, and they practice the grossest of sins; by comparison, we're good folk and surely God will take that into account. 'Our' sins are acceptable, but 'their' sins are not. Besides, who wants to hear judgment preached all the time; just preach on the love of God."<sup>339</sup>

---

<sup>336</sup>Thompson, p. 498.

<sup>337</sup>These verses occur again almost verbatim in 30:23-24.

<sup>338</sup>Kidner, p. 91.

<sup>339</sup>Drinkard, p. 345.

The brief message that follows corrected a false view of God that the false prophets were apparently promoting (vv. 23-24).

23:23 Evidently some of the false prophets were stressing the immanency of God but disregarding His transcendence. They were saying that He was with His people and would protect them, but they were not saying that He was also holy and must judge sin.

23:24 The people tried to hide from God in the sense that they did evil that they thought He could not see. The Lord reminded His people through Jeremiah that He is everywhere in the universe. There is no place where they could go to hide from Him (cf. Ps. 139; Amos 9:2-4).

Jeremiah condemned the false prophets for advertising their own dreams as revelations from Yahweh (vv. 25-32).

23:25 The Lord was aware that the prophets were falsely claiming to have had dreams in which they received messages from Him (cf. Zech. 10:2).

Dreams were one way that Yahweh communicated His revelations to people in ancient times (cf. Gen. 28:10-17; 37:5-11; 40; 41:1-45; Num. 12:6-8; 1 Kings 3:5-15; Dan. 2; 4:4-27; 7; Joel 2:28; Zech. 1:7—6:8). The pagans also viewed dreams as a way the gods communicated with them. Consequently it was possible to claim a revelation in a dream and to obtain an audience. The person who received a revelation from Yahweh in a dream knew it, but it was very difficult for someone else to know if the dream that a prophet claimed really came from Yahweh.

23:26-27 How long would these prophets continue to make the people forget the Lord's Word by continually claiming that they had received some new revelation from Him in a dream?! They were really leading the people away from Him just as their ancestors pursued Baal and forgot the Lord.

23:28 The false prophets could relate their dreams just as the true prophets could declare the Lord's words. But it would become clear eventually that the difference between these prophecies was as great as that between straw and grain. The one was insubstantial and worthless while the other was nourishing.

23:29 God's true words were as penetrating as fire and as powerful as a hammer. Both fire and a hammer are destructive yet refining.<sup>340</sup>

23:30-32 Yahweh announced His antagonism to the false prophets because they got messages from one another, or from their own minds, or from a dream,

---

<sup>340</sup>Ibid., p. 350.



and then claimed that they were from the Lord. They were misleading God's people and were not benefiting them in the least (cf. vv. 1-4). In our day many liberal preachers begin their messages with "In the name of the Father, the Son, and the Holy Spirit," and then proceed to deliver an unbiblical sermon.

The final message in this group deals with another claim by the false prophets. In addition to receiving dreams, they professed to communicate oracles from Yahweh (vv. 33-40).

23:33 When the people or the prophets or the priests asked Jeremiah what message he had received from the Lord, he was to reply that the Lord was going to abandon them. When they asked, What is the burden of the Lord? he was to respond, You are a burden to Him and He will cast you off.

The Hebrew word *massa'*, "oracle," comes from the same root as the verb *nasa'*, meaning "to lift, bear, or carry." Usually the noun refers to an imposed burden, imposed by a deity or master. Metaphorically it refers to any heavy burden, such as the burdens of leadership or duty. In the prophets, it often suggests a judgment or catastrophe. Thus an oracle is a burden or depressing message that deals with judgment (cf. Isa. 15:1; 17:1; 19:1; et al.).

23:34 Anyone who claimed to have a message from the Lord but did not would incur God's punishment (cf. Rev. 22:18).

23:35-36 The people would be confused about what the Lord really had said. They would not remember the messages that the Lord really had sent them because they always wanted to hear messages from the Lord that pleased them. They did not respond to the ones the living God, Almighty Yahweh their God, really did send, but they twisted them.

23:37-38 When someone asked a false prophet what message he had received from the Lord and the false prophet responded, "An oracle from Yahweh," he was lying. He should not claim to have an oracle from Yahweh when he did not have one. God commanded that this phrase should no longer be used because the false prophets had perverted His words (cf. vv. 25-32).

". . . though the term 'oracle' was used by canonical prophets (e.g., Isa 13:1; Nah 1:1; Hab 1:1; Zech 9:1; Mal 1:1), Jeremiah never used it of his own prophecies because it had become the hallmark of the lying prophets."<sup>341</sup>

23:39 Anyone who used this phrase would come under God's judgment. Because the false prophets made this claim, the Lord promised to forget them and

---

<sup>341</sup>Feinberg, p. 526.

throw them into exile (as a burden) along with the rest of the people of Jerusalem. This was especially sad because God had given Jerusalem to them and their forefathers.

23:40 Yahweh would also curse these false prophets with the eventual reproach of the people and their consequent shame forever. People would always remember them as false prophets. This was only fitting since they had made the people forget the Lord (v. 27). The people might forget the Lord, but they would never forget the coming judgment.

"The whole argument comes to us as rather complex, probably because the pun is developed in such a sustained manner. The two senses of *massa'*, 'prophetic utterance' and 'burden,' and the verb *nasa'* occur a number of times. The *massa'* of Yahweh is that the people are a *massa'*."<sup>342</sup>

### **A collection of burdens on many nations chs. 24—25**

The four messages that follow concern Judah (ch. 24), Babylon (25:1-14), other surrounding nations (25:15-29), and all the earth (25:30-38).

#### **The two baskets of figs ch. 24**

24:1 This prophetic message came to Jeremiah after Nebuchadnezzar had taken King Jehoiachin (Coniah, Jeconiah, cf. 22:24) and many of the other royal counselors, craftsmen, and smiths (or artisans) captive to Babylon in 597 B.C.<sup>343</sup> The people taken captive at this time constituted the cream of the country's leadership (cf. 2 Kings 24:14-15).

"After the exile of Jehoiachin and the leading citizens of Judah (2 K. 24:10-17), those who remained seem to have been full of optimism for the future. The new king Zedekiah even became involved in a conspiracy with the surrounding peoples for further rebellion against Babylon (ch. 27). The false prophets spoke of a quick return of the exiles from Babylon (ch. 28). Jeremiah saw that the attitude of the king and his supporters in Judah was wrong. True, there would be a new day for Judah and the people of God, but the future lay with the exiles and not with Zedekiah and his supporters."<sup>344</sup>

<sup>342</sup>Thompson, p. 506. Harrison, *Jeremiah and . . .*, pp. 122-23, wrote a helpful contrast between true and false prophets that is suggestive for contemporary life and ministry.

<sup>343</sup>Nebuchadnezzar was particularly interested in these types of people because he could employ them in his government and extensive building projects.

<sup>344</sup>Thompson, p. 507.

Jeremiah saw two baskets of figs in the temple courtyard (cf. 1:11-16; Amos 7:1-9; 8:1-3). This is where people brought their offerings, so these two baskets may have contained two offerings, perhaps first-fruit offerings. It is impossible to determine if Jeremiah saw this scene in a vision or in actuality. As a message his account of his experience resembles a parable.

- 24:2-3 In one basket there were very good figs, like the highly valued figs that matured in June (cf. Isa. 28:4; Hos. 9:10), and in the other there were such bad figs that no one could eat them. In Jeremiah's day it was not uncommon for people to bring less than the best to the Lord. Jeremiah explained what he saw to the Lord in answer to the Lord's question.
- 24:4-5 The Lord explained that He would regard the people that had gone into exile with Jehoiachin as good, like the good figs.
- 24:6 He would watch over them and return them to the Promised Land. He would cause them to flourish, like a building under construction or a plant that grows. No one would tear them down or uproot them (cf. 1:10; 12:14-17; 18:7-9; 31:27-28).<sup>345</sup>
- 24:7 God would give them a heart to know Him because, as Yahweh, He could do that. They would resume covenant relationship as Chosen People and God because the people would repent and return to God wholeheartedly.
- This change in the people only occurred partially during the Exile. We believe that final fulfillment is yet future when Jesus Christ returns (cf. 31:31-34; Ezek. 36:24-32; Matt. 24:29-31).<sup>346</sup>
- 24:8 The bad figs corresponded to King Zedekiah, his administrators, the people who remained in Jerusalem and Judah, and the Judahites who had already fled to Egypt for safety.
- "We are not told when people fled to Egypt, but those of pro-Egyptian sympathies may have settled there when Jehoahaz was taken there in 609 B.C. (2 K. 23:34) or when Jehoiakim became Nebuchadrezzar's vassal (cf. 603 B.C.) or even when Nebuchadrezzar invaded Judah in 598/7 B.C."<sup>347</sup>
- 24:9 They would become an object of terror and a source of evil for the other kingdoms of the earth. They would become objects of criticism, ridicule, cursing, and a proverb about what unfaithfulness to covenant can result in wherever they would go (cf. 19:8).

<sup>345</sup>For partial fulfillment, see 29:4-7; 2 Kings 25:27-30.

<sup>346</sup>Feinberg, p. 529; Dyer, "Jeremiah," p. 1160.

<sup>347</sup>Thompson, pp. 508-9.

24:10 The Lord would send war and its accompanying disasters, famine and disease, on those of them still in the land until they perished (cf. 21:7). Initial fulfillment came in 586 B.C. (cf. Deut. 28:25, 37), and an even more extensive one followed in A.D. 70 (cf. Matt. 23:38).

"The natural reaction to the fate of the captives deported in 597, and to the good fortune of those who were left behind, was to see the former as God's throw-outs, the *bad figs*; and to see the rest as his men of promise, the *good figs* that were worth keeping. But, as ever, God's thoughts and plans were not at all what men imagined."<sup>348</sup>

### **The length of the exile and Babylon's fate 25:1-14**

Chapter 25 serves as a capstone for all of Jeremiah's previous prophecies. The prophet's perspective now broadens quickly to include the whole world and divine judgments ordained for it.

25:1-2 Jeremiah received another prophetic message from the Lord in 605 B.C., which he delivered to the people of Jerusalem and Judah.<sup>349</sup> This was a timely prophecy because in this year Nebuchadnezzar defeated Pharaoh Neco at Carchemish. His victory resulted in the balance of power shifting in the ancient Near East from Assyria to Neo-Babylonia. The Judahites would have wondered how this change would affect them. Later the same year Nebuchadnezzar invaded Palestine, attacked Jerusalem, and deported some of the people of Judah to Babylon.

25:3 The prophet announced that he had been preaching to his audience regularly for 23 years, but they had not paid attention to what he had said. According to 1:2, Jeremiah began his ministry in 627 B.C.

25:4 The Lord had repeatedly sent other prophets to them, true prophets, but the people did not listen to them either.<sup>350</sup>

25:5-6 The message of all these prophets had been to turn from evil lifestyles and activities. If the people did, the Lord would allow them to remain in their land indefinitely. They were to reject the pagan deities and handmade gods that they served and worshipped because they angered Yahweh (cf. Matt. 4:10).<sup>351</sup> If they did, He would do them no harm.

25:7 Yet the people had not listened to the Lord but provoked Him to anger by making idols to their own harm.

---

<sup>348</sup>Kidner, p. 93.

<sup>349</sup>For a brief discussion of a minor chronological problem, see Dyer, "Jeremiah," p. 1160.

<sup>350</sup>Contemporary prophets included Uriah (26:20-23), Zephaniah, and Habakkuk.

<sup>351</sup>It is possible that "the work of your hands" is a general reference to their actions. The expression is ambiguous.

- 25:8-9 The Lord announced that because they had not obeyed Him He would bring Nebuchadnezzar down from the north and destroy them and their neighbor nations with an awful, everlasting devastation. Nebuchadnezzar was the Lord's servant in the same sense Cyrus was (cf. Isa. 44:28—45:1); he served the Lord by carrying out His will for the most part unwittingly (cf. 27:6; 43:10; Acts 2:23). Since God's people would not listen to His servants the prophets (v. 4), the Lord would send another type of servant to get their attention (cf. Isa. 28:11).
- 25:10 He would remove everyday joy from their lives, even the joy of new marriages, as well as the productivity of the people. They would run out of grain, oil, and other necessities. He would leave them dwelling in darkness. All these expressions refer to the ending of life (cf. Eccles. 12:3-6).
- "I must say that when I pray for my country and our culture, I do not pray for God's justice. I can only plead for His mercy. If we had the justice of God, we would not have peace. We would have a situation like Jeremiah's. How dare we pray for justice upon our culture when we have so deliberately turned away for God and His revelation? Why should God bless us?"<sup>352</sup>
- 25:11 The whole land would remain a horrible desolation for 70 years during which Israel and Judah would be absent from the Promised Land. This is the first prophecy of the length of the Babylonian captivity. The Israelites had not observed 70 sabbatical years, so the seventy-year exile restored rest to the land (2 Chron. 36:20-21).
- 25:12 After 70 years, the Lord promised to punish the king of Babylon and his nation for their sins and make their land a desolation forever (cf. Hab. 1—2).<sup>353</sup> Babylon fell in 539 B.C. when Cyrus the Persian captured and overthrew it.<sup>354</sup> It did not become a complete desolation, however, which has led literal interpreters to conclude that a future destruction of Babylon will fulfill this prophecy (Rev. 16:19; 17:1—19:10).<sup>355</sup>

---

<sup>352</sup>Schaeffer, pp. 50-51.

<sup>353</sup>Daniel was reading this passage or the one in 29:10 when God gave him the prophecy of the seventy weeks (sevens) of years yet future (Dan. 9:2).

<sup>354</sup>Cyrus the Persian was also known as Darius the Mede (Dan. 5:30).

<sup>355</sup>Some literal interpreters believe that this requires the rebuilding of the city of Babylon. Most believe it only requires the future fall of the nation. See my comments on chapters 50—51. See also Chisholm, "A Theology . . .," pp. 349-50, for an excursus on Jeremiah's prophecy of seventy years.

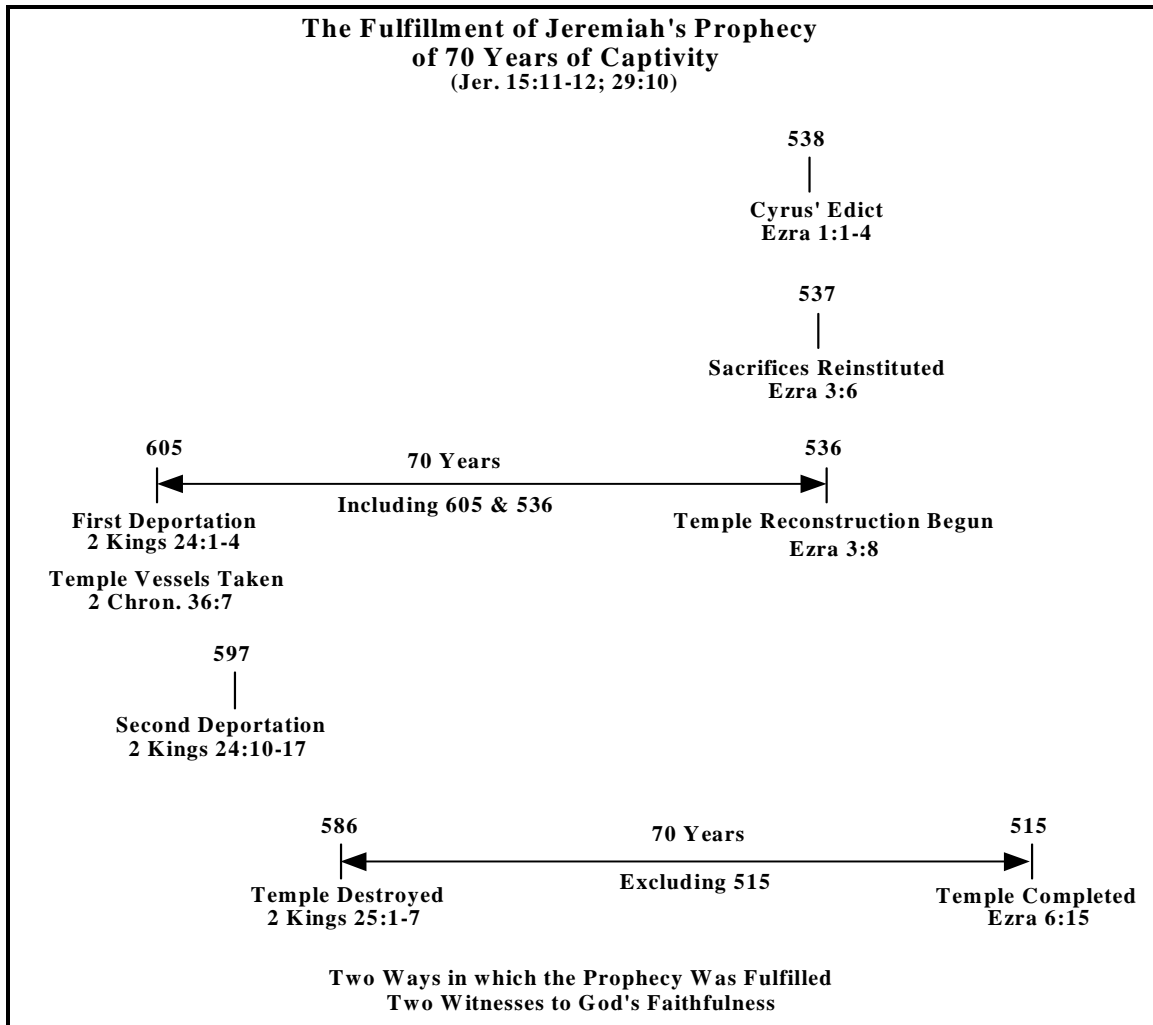

25:13 The Lord would fulfill all the prophecies that Jeremiah had giving concerning Babylon. When the Lord made this promise some of Jeremiah's prophecies were already in a book.

25:14 Other nations and great kings would enslave the Babylonians, Judah's mighty captors. Yahweh would pay back Babylon for all that she had done (cf. Hab. 1—2). Some of these many nations with great kings included the Medes, the Persians, and their several allies under Cyrus the Great.

**Yahweh's cup of wrath for the nations 25:15-29**

25:15 The Lord instructed Jeremiah to take from His hand, figuratively, a cup of His wrath and to cause all the nations to whom the Lord would send him to drink from it. The cup is a common figure for the wrath of God in Scripture (cf. 13:12-14; 49:12; 51:7; Job 21:10; Ps. 60:3; Isa. 51:17, 21-22; Lam. 4:21; Ezek. 23:31-34; Hab. 2:16; Mark 10:39; 14:36; Luke

22:42; John 18:11; Rev. 14:8, 10; 16:19; 18:6).<sup>356</sup> This was another symbolic action that God prescribed to communicate to His people, though in this case the action was not literal.

25:16 The outpouring of divine wrath on them, in war, would make them behave as though they had drunk too much wine. They would stagger around and lose control of their senses. Drunkenness in the Bible is sometimes a symbol of a sinful state that calls for judgment (cf. 13:12-14; Isa. 19:14; 28:7-13).

25:17 Jeremiah gave the messages of divine judgment to the nations to which God sent him.<sup>357</sup>

"This section identifying the judgments of God against the evil nations is expanded in chapters 46 through 51. These chapters are appropriately held off until the end of the book of Jeremiah since the main burden of the prophet is the destiny of his own people, Judah, and the record would therefore give precedence to this. Furthermore, the judgments upon the evil nations would fall after the judgment upon Judah, and so the position of chapters 46 through 51 is chronologically fitting at the end of the book."<sup>358</sup>

25:18-26 Jeremiah sent messages of judgment to Jerusalem and Judah, Egypt, the land of Uz (to the east, Job 1:1), Philistia, Edom, Moab, Ammon, Tyre and Sidon and their colonies in the Mediterranean, the desert areas of Dedan and Tema (both southeast of Edom), Buz (possibly in northern Arabia), some desert Arab tribes and nations, Zimri (perhaps between Arabia and Persia), Elam and Media (east of the Tigris River), other nations farther north and everywhere else, and Babylon.<sup>359</sup> Babylon conquered all these other nations.

25:27 Jeremiah was to announce the doom of all these nations by military conquest. Their fate would be similar to that of a drunken man.

25:28 If they refused to accept Jeremiah's prophecies, the prophet was to tell them that they would experience God's judgment anyway.

---

<sup>356</sup>It is also a symbol of God's blessing (cf. Ps. 16:5; 23:5; Luke 22:17, 20; 1 Cor. 10:16; 11:24-25). In a larger sense it refers to one's lot in life be it cursing or blessing.

<sup>357</sup>The following list of nations differs from the nations addressed in chapters 46—51 only slightly. Damascus does not appear here, but other nations not in that later group do. See the map of the ancient Near East at the end of these notes.

<sup>358</sup>Jensen, p. 75.

<sup>359</sup>The name Sheshach (v. 26) is apparently a code name for Babylon that the writer may have used when writing under Babylonian scrutiny. See Feinberg, p. 535. The same code, called atbash, occurs in 51:1 and 41 (cf. 1 Pet. 5:13). For further explanation of this code, see Dyer, "Jeremiah," p. 1162.

25:29 God's work of judgment in Jerusalem was just the beginning of larger scale judgment that would extend to all nations (cf. Amos 3:2; 1 Pet. 4:17). Final fulfillment awaits the return of Jesus Christ when He will destroy all nations that oppose Him (Rev. 16:14-16).

### **Universal judgment to come 25:30-38**

25:30 Jeremiah was also to announce that God would prepare to judge all the inhabitants of the earth (v. 29). As a lion announces its intent to attack with a roar, so Yahweh would one day announce His attack on earth-dwellers (cf. Rev. 6).<sup>360</sup> He would vigorously tread the nations in the winepress of His wrath (cf. Rev. 14:18-20; 16:14-16). This anticipates Tribulation judgments (Rev. 6—18).

25:31 His judgment would cause clamor worldwide. He would judge everyone because He holds them guilty in a lawsuit. The wicked would die violent deaths.

25:32 Almighty Yahweh also announced that evil was spreading all over the world. As a result, a storm of divine judgment of global proportions was also being stirred up.

25:33 The Lord would slay people in all parts of the world during this judgment. So many people would die that they would lie on the ground unburied like manure (cf. Rev. 14:20).

25:34 Leaders of peoples then should mourn and weep because the day of their destruction and the dispersion of their nations had come. In this judgment the shepherds would die along with the sheep. Like a choice piece of pottery these nations would fall and break apart.

25:35-37 The leaders would not be able to escape the judgment but would weep and wail over their fate. They would bewail the fact that Yahweh was destroying their nations in His fierce anger (cf. Rev. 16:8-11).

25:38 The Lord would leave His place of obscurity and attack His enemies like a lion (cf. v. 30; Rev. 19:11-21). The earth would become a devastation because the Divine Warrior would vent His fury.

This is the end of the collection of prophecies that were warnings of judgment on Judah and Jerusalem (chs. 2—25).

---

<sup>360</sup>A less likely interpretation, I think, is that the roar is thunder, the metaphorical voice of God.



## **B. CONTROVERSIES CONCERNING FALSE PROPHETS CHS. 26—29**

These chapters contrast the true prophet of Yahweh with the false prophets. Distinguishing between them was difficult for Jeremiah's contemporaries, but their essential difference is clear. The true prophets proclaimed the Lord's words, and the false prophets announced their own messages. It is the response to Jeremiah's preaching that these chapters stress rather than the content of his preaching, which is the emphasis in chapters 1—25.

"The subject of the previous five chapters has been the certainty of judgment to come. In the next four chapters attention is directed to the man Jeremiah, who preached the message of judgment."<sup>361</sup>

### **1. Conflict with the people ch. 26**

This section consists of four parts: a summary of Jeremiah's Temple Sermon (vv. 2-6), the prophet's arrest and trial (vv. 7-16), the elders' plea for his life (vv. 17-19, 24), and the incident involving Uriah and his execution (vv. 20-23). As the other chapters in 26—45, this one contains an incident out of Jeremiah's life.

26:1 Another message from Yahweh came to Jeremiah at the beginning of King Jehoiakim's reign. Jehoiakim began reigning over Judah in 609 B.C. The terminology used to describe the date is technical referring to the time between the king's accession to the throne and the first full year of his reign.<sup>362</sup> This is the earliest date mentioned in the book with the exception of Jeremiah's call (1:2).

"Little more than three months had seen King Josiah killed in battle, his successor deported to Egypt, and this third king, a man of no scruples, imposed on the country. At such a moment, to give strong warnings of potentially worse things in store was to take one's life in one's hands, especially when these warnings touched the temple and the holy city, popularly thought to be inviolable."<sup>363</sup>

26:2 The Lord commanded His prophet to stand in the temple courtyard and deliver every word of this message to the people who came there. He was not to omit one word for fear of the consequences of his preaching nor to trim his message to please his hearers. The occasion may have been a special feast since people from many parts of Judah came to the temple then. What follows is a summary of the Temple Sermon previously recorded in 7:1-15, but here the reaction that the sermon created is the

---

<sup>361</sup>Jensen, p. 76.

<sup>362</sup>Thompson, p. 524.

<sup>363</sup>Kidner, p. 96.

main point. This message also summarizes the essential content of chapters 7—10.

- 26:3 There was still hope that the people would repent and avoid the judgment that God would bring upon them for their sins.
- 26:4-6 Jeremiah's message was that if the people continued to refuse to listen to the Lord through His prophets and to disobey the Mosaic Covenant, He would destroy the temple and Jerusalem. The temple would suffer complete destruction as the town of Shiloh had, and Jerusalem would become a curse, namely, an object of ridicule and an example of horrible suffering (cf. Gen. 12:3). Making the temple like Shiloh would involve three things: desecration of the sanctuary, removal of the holy furniture, and withdrawal of Yahweh's name.<sup>364</sup> The Philistines evidently destroyed the town of Shiloh about 1104 B.C. during the battle of Aphek (cf. 7:12, 14; 1 Sam. 4).
- 26:7-8 When the priests, prophets, and people heard this message, they laid hold of Jeremiah and threatened to put him to death.<sup>365</sup>
- 26:9 His accusers asked why he had given such a prophecy against the temple and Jerusalem. They believed that in view of God's promises He would never forsake the temple or the capital. Thus Jeremiah appeared to them to be a false prophet and to be blaspheming God, capital offenses in Israel.
- 26:10 When the princes of Judah heard what had happened they left the palace complex and assembled at the New Gate of the temple (cf. 20:2; 2 Kings 15:35). Gates were the normal sites of court sessions (cf. Gen. 23:10-20; Deut. 21:19; Ruth 4:1; 2 Sam. 15:2; Prov. 31:23; Amos 5:10-12). The exact location of the New (Benjamin, Altar, Upper, North) Gate is unknown, though it was an opening in the barrier that separated the outer and inner courtyards on the north side of the temple (cf. 36:10; Ezek. 8:3, 5; 9:2).<sup>366</sup>
- 26:11 Jeremiah's accusers demanded that the princes pass a death sentence against the prophet for saying what he did.<sup>367</sup>

"When a man stands up in the communist or other totalitarian countries today and really speaks of the judgment of God, he gets the same treatment as Jeremiah. Even in the West the results are similar. Men say, 'You're

<sup>364</sup>Pamela J. Scalise, *Jeremiah 26—52*, p. 16. This commentary appears under Keown, Scalise, and Smothers in the bibliography.

<sup>365</sup>According to Scalise, p. 7, verses 8-16 contain the only complete trial account in the Old Testament.

<sup>366</sup>See the diagram near 20:2.

<sup>367</sup>The Book of Jeremiah records no face-to-face encounter between Jeremiah and King Jehoiakim.

against our culture, you're against the unity of our culture, you're against the progress of our culture, you're against the optimism of our culture, and we're going to do what we can against you.' Our culture may do little if we preach only the positive message but if we are faithful and also preach judgment in state or church, the result will be the same as with Jeremiah."<sup>368</sup>

- 26:12 Jeremiah responded with a threefold defense. He said that he had simply preached a message that Yahweh had sent him to deliver; he had not spoken presumptuously (cf. Deut. 18:20).<sup>369</sup>
- 26:13 He then underlined the importance of all the people repenting. If they did, they could avert the Lord's threatened judgment (cf. 18:1-12).
- 26:14-15 Finally, Jeremiah yielded himself to the will of the people but warned them that if they killed him they would be guilty of shedding innocent blood since Yahweh really had sent him with his message.
- 26:16 The officials and some of the people then defended Jeremiah saying that he had brought a message from Yahweh and should not die for having done so. They concluded that he was neither a false prophet nor a blasphemer (cf. John 19:4).
- 26:17-19 Some of the older men reminded the gathering that the prophet Micah had predicted a similar fate for Jerusalem, and King Hezekiah (715-686 B.C.) had not put him to death (cf. Mic. 1:1; 3:12). Hezekiah had prayed to the Lord and the Lord had relented (2 Kings 19:1, 15-19). They would be doing something wicked if they killed Jeremiah.<sup>370</sup>
- ". . . while the people and the princes recognized Jeremiah's divine authority, they apparently still refused to amend their ways and obey God's voice, or this would have been the beginning of spiritual awakening in the nation, a change which Jeremiah longed to see."<sup>371</sup>
- 26:20 Another prophet, Uriah ben (the son of) Shemaiah from Kiriath-jearim, about 8 miles west of Jerusalem, preached against Judah and Jerusalem in the Lord's name, as Jeremiah did.

---

<sup>368</sup>Schaeffer, p. 60.

<sup>369</sup>The Apostle Paul similarly defended his message in his epistle to the Galatians.

<sup>370</sup>According to Harrison, *Jeremiah and . . .*, p. 128, this is the only direct citation of another prophet's words in the prophetic literature of the Old Testament.

<sup>371</sup>Jensen, p. 78.

- 26:21 When Jehoiakim and his soldiers and administrators heard what Uriah said, they tried to execute the prophet. But he became afraid and escaped to Egypt.
- 26:22-23 The king sent a delegation of representatives to Egypt and brought Uriah back to Jerusalem. Elnathan ben Achbor had been one of Josiah's officials, and he may have been Jehoiakim's father-in-law (2 Kings 22:12, 14; 24:8). He later tried to stop Jehoiakim from destroying Jeremiah's prophecies (36:25).

"The extradition of political refugees was frequently inserted as one of the clauses in the treaties of the second millennium B.C. We may conjecture that there was a suzerain-vassal treaty between Egypt and Judah since Necho placed Jehoiakim on the throne in 609 B.C. and required him to pay tribute (2 K. 23:34-35). Such extradition clauses were reciprocal, becoming part of international law."<sup>372</sup>

The king put Uriah to death and gave his body an undistinguished burial, probably in the valley of Kidron (cf. 2 Kings 23:6).<sup>373</sup> God does not protect all His faithful servants from death at the hands of their enemies.

#### Shaphan's Sons and Grandsons

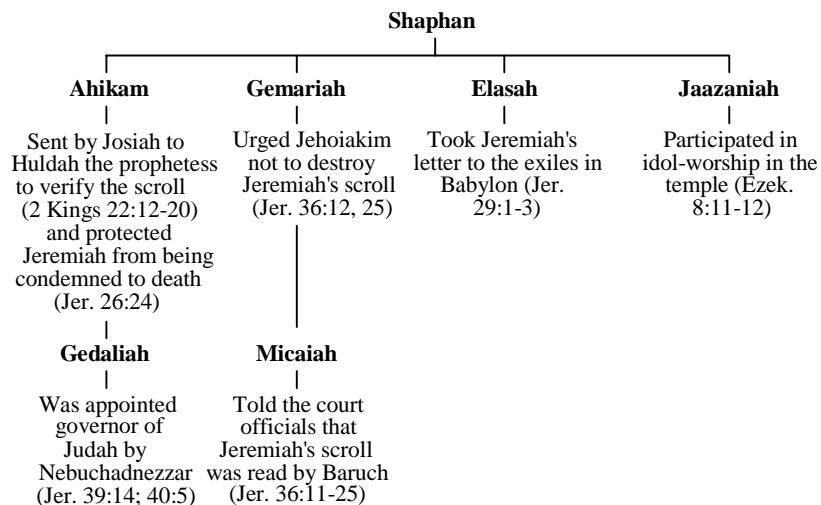

- 26:24 However, Ahikam exercised his influence and Jeremiah escaped death. Ahikam and his family came to Jeremiah's aid more than once (cf. 36:10, 25; 39:14; 40:5-16; 2 Kings 22:3-14; 25:22).

<sup>372</sup>Thompson, p. 527.

<sup>373</sup>The prophet Zechariah is the only other prophet whose execution the Old Testament records (Matt. 23:35; cf. 2 Chron. 24:20-22). However, there appear to have been other martyrs among the prophets (cf. Matt. 23:37; Luke 13:34). Perhaps the writer included the information about Uriah's death to help us appreciate the great danger in which Jeremiah stood.

The priests of Jerusalem later brought Jesus Christ and the apostles to trial and charged them with preaching the destruction of the temple (cf. Matt. 24:2; 26:57-68; Mark 14:58; Acts 6:12-14; 21:28-36).

## **2. Conflict with the false prophets in Jerusalem chs. 27—28**

Chapters 27 and 28 record the controversies Jeremiah had with false prophets in Jerusalem before the Babylonian captivity. The events recorded may have happened sometime after a failed coup attempt against Nebuchadnezzar in Babylon in December of 595 and January of 594 B.C.<sup>374</sup>

### **Jeremiah's warning against making a coalition to resist Nebuchadnezzar ch. 27**

This chapter contains three parts: Jeremiah's warning to the foreign messengers (vv. 1-11), his appeal to King Zedekiah (vv. 12-15), and his appeal to the priests and people of Jerusalem (vv. 16-22).

27:1            Jeremiah received a message from the Lord toward the beginning of King Zedekiah's reign.<sup>375</sup> The first verse of chapter 28 locates the time of this prophecy more exactly, namely, in the king's fourth year (594 or 593 B.C.).

27:2            The prophet was to make fetters, specifically yokes, and to put one set of them on his neck. Evidently Jeremiah walked around wearing this half-filled yoke as a lopsided burden to illustrate his message. This was another of his symbolic acts (cf. 13:1-11; 19:1-13; 1 Kings 22:11; Isa. 20). The animal yoke, of course, represented submission, servitude, and captivity (cf. 1 Kings 22:11; Ezek. 7:23).

27:3-4         Jeremiah was then to send word to the kings of Edom, Moab, Ammon, Tyre, and Sidon through the envoys that had come from those places to visit King Zedekiah (cf. 25:21-22).<sup>376</sup> These ambassadors were to take a message from Yahweh back to their masters. He apparently made one set of the object lesson for each of the ambassadors to take back home with him.<sup>377</sup>

The Babylonian Chronicles illuminate the historical background of this situation. Two years earlier an unnamed enemy had attacked

---

<sup>374</sup>Dyer, in *The Old . . .*, p. 615.

<sup>375</sup>E. Henderson, *The Book of the Prophet Jeremiah*, p. 171, noted that the Jews sometimes divided periods of time into halves: the beginning half and the end half. Thus the writer meant that this prophecy came in the first half of Zedekiah's reign (cf. 28:1).

<sup>376</sup>These kingdoms had all been vassals or treaty partners with David and Solomon in the past (cf. 2 Sam. 8:11-12; 1 Kings 5; 7:13-47).

<sup>377</sup>This is the meaning of the Hebrew text, though the Septuagint suggests that Jeremiah made only one yoke.

Nebuchadnezzar, and the following year he had to deal with a revolt within his borders. Smaller nations in the west saw this as an opportunity to throw off Babylon's authority. The same nations had formed a confederacy to revolt against Assyria years earlier, so the purpose of these messengers seems to have been to form another treaty but this time against Babylon.<sup>378</sup> The recent accession of Psammetik II as Pharaoh of Egypt may have been another inducement to revolt.<sup>379</sup>

27:5 Yahweh announced that He was the creator of all things and would give His creation to whomever was pleasing in His sight.

"Marduk of Babylon might claim authority over nations by right of conquest, but the LORD claims the right to rule as creator."<sup>380</sup>

27:6-7 The Lord had determined to give their lands to Nebuchadnezzar, His servant (cf. 25:9; 43:10), until the time came when He would turn over Nebuchadnezzar's lands to another master (i.e., Cyrus the Persian). This would not be until Nebuchadnezzar's son and grandson had ruled, however, namely, Evil-Merodach and Belshazzar (52:31; Dan. 5:1, 30).

27:8 If any of the nations Jeremiah was addressing failed to submit to Nebuchadnezzar, the Lord would destroy that nation using Nebuchadnezzar as His instrument. War, famine, and disease would follow resistance to the Babylonian invader.

"To resist the known will of God is always spiritual suicide."<sup>381</sup>

27:9-10 These foreign kings should not listen to their counselors and prophets who advocated resistance to Nebuchadnezzar. If they did, they would only experience greater destruction, deportation, and death.

27:11 However, if those kings surrendered to Nebuchadnezzar, their people would be able to remain in their own land and live in it.

**Kings of the Neo-Babylonian Empire**

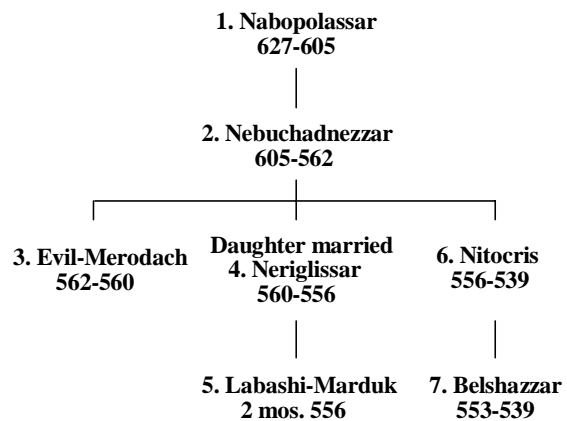

<sup>378</sup>Thompson, p. 532.

<sup>379</sup>Feinberg, p. 544.

<sup>380</sup>Scalise, p. 49.

<sup>381</sup>Feinberg, p. 544.

"To be able to discern the signs of the times (Mt. 16:3) and know what the will of the Lord is (Eph. 5:17) demands close fellowship with God and an obedient, perceptive spirit."<sup>382</sup>

27:12-13 Jeremiah also counseled Zedekiah to surrender to Nebuchadnezzar. If he did, the Judahites could continue to live. But if he resisted, the people of Judah would die by the sword, starvation, and sickness.

27:14-15 Jeremiah told Zedekiah not to listen to the false prophets who were advocating resistance because Yahweh had not sent them. Listening to their advice would result in exile and death for the king and the false prophets.

"To underestimate the power of a lie in times of national distress is sheer folly."<sup>383</sup>

27:16 Jeremiah also prophesied to the priests and the people assuring them that the prophecies of the speedy end of the captivity and the soon return of the people that had already gone into exile were lies.

27:17 The priests and people should not listen to these false prophets. They should submit to Nebuchadnezzar and live rather than resisting and see Jerusalem destroyed.

27:18 If the false prophets were true, they should ask Yahweh to keep the remaining furnishings and accessories still in Jerusalem from being taken captive to Babylon (cf. 2 Kings 25:13-17; Dan. 1:1-2). The granting of their petition would validate them as authentic prophets.

27:19-22 The Lord's word concerning these treasures of the temple, palace, and city was that Nebuchadnezzar would take them to Babylon where they would remain until the Lord restored His people to their land (cf. Ezra 1:7-11).

### **Jeremiah's conflict with Hananiah ch. 28**

Jeremiah's symbolic act of wearing a yoke led to another symbolic act, the breaking of that yoke. Jeremiah's act brought a false prophet into direct confrontation with the true prophet.

28:1 The following event took place in the same year as the preceding one, 594 or 593 B.C., in the fifth month. Another prophet, Hananiah ben Azzur from Gibeon in Benjamin (about 5 miles northwest of Jerusalem), spoke to

---

<sup>382</sup>Harrison, *Jeremiah and . . .*, p. 129.

<sup>383</sup>Feinberg, p. 545.

Jeremiah in the temple courtyard before the priests and the people who had assembled there (cf. 27:16).<sup>384</sup>

- 28:2-3 Hananiah prophesied that Yahweh had broken Babylon's authority over Judah. Within two years the Lord would return to the temple the vessels that Nebuchadnezzar had already taken to Babylon. Hananiah, whose name means "Yahweh has been gracious," announced a message that Yahweh would be gracious.<sup>385</sup> Jeremiah predicted that the captivity would last 70 years (25:11-12; 29:10), but Hananiah predicted it would last only two years.
- 28:4 The Lord would also return Jeconiah (Jehoiachin) and the people who went with him to Babylon as captives, Hananiah predicted, because Yahweh would break Babylon's yoke. This flatly contradicted Jeremiah's prophecy that Jeconiah would die in Babylon (22:24-27; cf. 52:31-34).
- 28:5-6 Jeremiah responded to Hananiah sincerely but ironically. So be it, he said. Would that the Lord would do just as Hananiah had predicted. Jeremiah wished that Hananiah's prophecy would come true because he loved his people and his land and did not want them to experience the horrors of invasion and a long exile.
- 28:7 Yet Jeremiah urged the people to listen to what he was about to say to them. What Jeremiah wished would happen would not.
- 28:8-9 Time would tell, he said, whether Hananiah's prophecies of peace or Jeremiah's prophecies of war were truly from Yahweh. One of the tests of a true prophet in Israel was the fulfillment of his predictions (cf. 23:16-40; Deut. 18:21-22).
- "Jeremiah's meaning was that the usual message of the earlier prophets was one of doom, and that when he spoke of judgment he was more in the line of the predecessors than Hananiah, who spoke only of peace and prosperity (Deut. 18:20-22)."<sup>386</sup>
- 28:10-11 Hananiah proceeded to deliver a symbolic act of his own by vandalizing Jeremiah's sign. He dramatically smashed the yoke that Jeremiah had been wearing on his neck (cf. 27:2). He claimed that similarly within two years Yahweh would break the yoke of Nebuchadnezzar off the neck of all the nations that he was oppressing.

---

<sup>384</sup>Ironically, the Gibeonites had deceived the Israelites in Joshua's day (Josh. 9:1-15), and now a man from Gibeon would again try to deceive the Israelites.

<sup>385</sup>There are about 14 different Hananiahs in the Old Testament; his was a common name. This man probably appears only here, though he may have been the brother of Jaazaniah whom Ezekiel denounced (Ezek. 11:1-3).

<sup>386</sup>Thompson, p. 540.



28:12-13 Shortly after these events, the Lord told Jeremiah to return to Hananiah with a message. He told the false prophet that by breaking the wooden yoke off Jeremiah's neck he had only made Nebuchadnezzar's oppression more certain. Failure to repent had resulted in more certain judgment.

". . . we only add to our chastening when we resist it—  
exchanging wood for iron."<sup>387</sup>

28:14 Jeremiah told Hananiah that Yahweh of Hosts, Israel's God, said that all the nations round about would serve Nebuchadnezzar. The Babylonian king would even control the beasts; his supremacy would be total. Nothing the people could do would divert this judgment (cf. Acts 20:26-27). His yoke over them was as unbreakable as iron (cf. 15:12).

28:15-16 Jeremiah also told Hananiah that the Lord had not sent the false prophet. Furthermore, the Lord had revealed that He would take Hananiah's life within a year because he had encouraged the people to rebel against the Lord's word. The penalty that false prophets were to suffer under the Mosaic Covenant was death (Deut. 18:20).

"It is a serious thing indeed to use the name of God to say that secondary solutions can cure our problems when the real problem is that people have turned away from God and the truth that He has revealed in verbalized, propositional form concerning Himself."<sup>388</sup>

28:17 Sure enough, about two months later Hananiah died (cf. v. 1; 2 Kings 1:17; 7:19-20; 8:10-15; Ezek. 11:13; Acts 5:1-11). The prophet who predicted deliverance in two years died in two months. God graciously gave him two months to repent before He put him to death. His death was another object lesson to the people on the importance of obeying God's word.

"In chapters 26—29 the deaths of four prophets are predicted and/or reported. Of the prophets named in these chapters, only Jeremiah survives to see the fulfillment of the prophecies given to him by the LORD."<sup>389</sup>

### **3. Conflict with the false prophets in exile ch. 29**

This chapter continues the theme of the previous three, namely, controversies about false prophets. Jeremiah also had problems with the false prophets who were part of the 3,023 exiles who went into captivity in 597 B.C. (52:28).

---

<sup>387</sup>Kidner, p. 99.

<sup>388</sup>Schaeffer, p. 59.

<sup>389</sup>Scalise, p. 58.

There are references to and citations from at least four letters that went back and forth between Jerusalem and Babylon in this narrative.<sup>390</sup> Three of them were from Jeremiah, and one was from a false prophet in Babylon. We do not know exactly where in Babylon Jeremiah's letters went, but the largest settlement of exiles was near Nippur, close to the Kabar canal.<sup>391</sup>

Jeremiah wrote a letter to the exiles (vv. 1-23).<sup>392</sup> He then wrote a letter to the false prophet Shemaiah in Babylon (vv. 24-28) in which he referred to a previous letter that Shemaiah had written to the priest Zephaniah, who lived in Jerusalem (vv. 26-28). Finally, Jeremiah wrote a third letter, this time to the exiles again (vv. 31-32).

Within all this correspondence there are two promise oracles (concerning the exiles' immediate future, vv. 4-7; and concerning Israel's distant future, vv. 10-14). There are three judgment oracles (on false prophets, vv. 16-19, 21-23, 31-32), a warning oracle (concerning false prophets, vv. 8-9), and an unfinished though implied judgment oracle (concerning a false prophet, vv. 25-28).

### **Jeremiah's first letter to the exiles 29:1-23**

- 29:1-3        Jeremiah sent a letter to all the Judahites who had gone into exile in Babylon with King Jeconiah (Jehoiachin) in 597 B.C. We do not know the date of its composition, but Jeremiah probably wrote it within a few years of 597 B.C. The recipients included the elders, priests, prophets, the queen mother (Nehushta), court officials, princes, craftsmen, smiths (or artisans), and other citizens. King Zedekiah sent Elasah, one of Shaphan's sons (cf. 26:24), and Gemariah ben Hilkiah (36:10-26; cf. 2 Kings 22:3-14) to Babylon to deliver the letter. Both of these messengers were friendly toward Jeremiah, as is clear from other references to them. It was customary for vassals, such as Zedekiah, to communicate frequently with their overlords, like Nebuchadnezzar, in the ancient Near East.<sup>393</sup>
- 29:4        The letter was really a message from Yahweh Almighty, Israel's God. The exiles needed to recognize that He had sent them to Babylon; they were not there primarily because of Nebuchadnezzar. This reminder would have assured them of His sovereign control over the affairs of their lives.
- 29:5-7       The exiles were to settle down in Babylon and carry on life as usual rather than planning to return home soon. They were to build houses, plant gardens, marry, have children, and anticipate grandchildren.

---

<sup>390</sup>According to Feinberg, p. 551, verses 1-23 contain the first letter in the Bible. For other letters in the Old Testament, see 2 Chron. 21:12-15; 30:1, 6-9; 32:17; Ezra 1:2-4; 4:9-22; 5:7-16; 6:3-12; 7:12-26.

<sup>391</sup>Harrison, *Jeremiah and . . .*, p. 132.

<sup>392</sup>Scalise, p. 65, suggested that what Jeremiah sent the exiles was more like a booklet containing a collection of prophecies than a simple letter. This letter contains several messages from Yahweh.

<sup>393</sup>S. A. Meier, *The Messenger in the Ancient Semitic World*, p. 131.

"The external circumstances are far removed from humanity's first home in a fruitful garden, but the divine blessing and human task are remarkably similar (compare Gen. 1:28-29; 2:8-9, 15-16)."<sup>394</sup>

The exiles were also to seek the welfare of the city to which they had gone rather than plotting its downfall. They were even to pray for Yahweh's blessing on it (cf. Ps. 122:6; Matt. 5:43; Rom. 12:21; Titus 2:10; 1 Pet. 2:18). They would prosper as the city prospered. Ezekiel indicated that the exiles had their own organization of elders (Ezek. 8:1; 14:1), so many of the exiles followed Jeremiah's instructions. They were neither slaves nor prisoners in Babylon but enjoyed considerable autonomy.

"History shows that in all the centuries of their world-wide dispersion, the Jews have tried to follow this pattern. They have identified themselves with the country of their residence, while at the same time looking toward eventual restoration to their native land."<sup>395</sup>

29:8-9 The Lord instructed the exiles not to let the prophets among them deceive them into thinking that the captivity would be short. Such predictions were not from Him.

29:10 The captivity would last 70 years (cf. 25:11-12).

"It is remarkable that Jeremiah was able to propose that the power of Babylon would last so brief a time."<sup>396</sup>

At the end of that time, the Lord would again intervene in their affairs, fulfill His promise to them, and bring them back to the Promised Land. This is one indication that God wanted the exiles to return at the end of the captivity. Those who chose to remain in Babylon then were acting contrary to God's will for them (cf. 50:8; 51:6; Deut. 30:1-5; Isa. 48:20).

29:11 The Lord's plans for His people were for their ultimate welfare, not endless calamity. They would have a future beyond the Exile, so they could have hope.

29:12-13 At the end of the Exile God's people would call out to Him in prayer (cf. Dan. 9). Yahweh promised to listen to them. They would find Him when they sought Him wholeheartedly.

---

<sup>394</sup>Scalise, p. 80.

<sup>395</sup>Feinberg, p. 553.

<sup>396</sup>Thompson, p. 547.

- 29:14 Again He promised that they would find Him. He would then restore their fortunes and would gather them from all the places where He had driven them and return them to the Promised Land.
- Since the exiles did not seek the Lord wholeheartedly, and since He did not return all of them to the land at the end of the Exile, premillennialists look for a fulfillment of these promises in the future.<sup>397</sup> The returns from exile under Zerubbabel, Ezra, and Nehemiah were only partial fulfillments of these promises. Most of the exiles chose to remain in Babylon (e.g., Mordecai and Esther).
- 29:15 The people were concluding falsely that the Lord had raised up prophets for them in Babylon. He did indeed raise up Ezekiel and Daniel, but false prophets are in view here, as is clear from the following verses.
- 29:16-17 Verses 16-19 are a digression that stresses the fact that the Lord would complete the judgment of Judah before any restoration would begin.
- The true message from Yahweh concerning the Davidic king, Zedekiah, and the remaining Judahites who were still in the Promised Land was that they would experience war, famine, and plagues. They would be like rotten figs: good for nothing (cf. 24:2-3).
- 29:18-19 The Lord Himself would drive them from the land and kill them. They would become objects of horror and shame to the nations where He would drive them because they had not listened to His servants the prophets. The Lord had sent these messengers to them repeatedly, but they would not listen.
- 29:20 Since the Judahites still in the Promised Land had not listened to God and would therefore suffer punishment, it was important that the exiles pay attention to the Lord's words to them.
- 29:21 The Lord also announced the fate of two false prophets in Babylon: Ahab ben Kolaiah and Zedekiah ben Maaseiah. Yahweh would deliver them into Nebuchadnezzar's hand, and the Babylonian king would execute them in the sight of the exiles.
- 29:22-23 Their deaths would become a proverbial curse (Heb. *qelalah*) for the exiles who wanted to wish the worst type of fate on someone. They would wish that Yahweh would make the end of their enemies as terrible as that of those two false prophets. The Hammurabi Code refers to burning people alive (Heb. *qalah*) as a Babylonian method of execution, as does the Book of Daniel (cf. §25, §110, §157; Dan. 3:6).<sup>398</sup> These false

---

<sup>397</sup>See Kaiser, pp. 110-12; Feinberg, p. 555.

<sup>398</sup>Pritchard, ed., pp. 167, 170, 172.

prophets had acted like fools, had committed adultery in violation of the covenant (Exod. 20:14), and had falsely claimed to announce messages from Yahweh. The Lord said He knew exactly what these men were doing. Nebuchadnezzar would not have executed these men for these offenses, so probably they were guilty of other political crimes as well, perhaps encouraging the exiles to revolt.<sup>399</sup>

### Jeremiah's letter to Shemaiah in Babylon 29:24-28

Jeremiah wrote another letter, this time in response to a letter that the false prophet Shemaiah in Babylon wrote to Zephaniah the priest and the Judahites still in Jerusalem. Jeremiah quoted Shemaiah's letter, and it fills most of this section (vv. 26-28). Shemaiah's letter was a reaction to Jeremiah's first letter to the exiles (vv. 1-23).

29:24 The Lord had a message for Shemaiah the Nehelamite, too. There are no other references to this man in the Bible. "Nehelamite" may come from the Hebrew word *halam*, meaning "to dream." Thus this may be a nickname for him: the dreamer (cf. v. 8; 27:9).<sup>400</sup> This word could also be the name of his family or birthplace, though no other families or places of that name are known.

29:25-26 This man had sent letters in his own name, not in Yahweh's name, to Zephaniah ben Maaseiah the priest, the other priests, and the people in Jerusalem. He had told them that the Lord wanted Zephaniah to be the priest in charge of order in the temple instead of Jehoiada, the authorized priest.<sup>401</sup> Zephaniah was to put any "mad man" who prophesied in the Lord's name in the stocks and his neck in an iron collar (cf. 20:1-3).<sup>402</sup>

"The irony is that Zephaniah would, according to Deut 28:34, become a madman himself when he witnessed the judgment coming upon Jerusalem."<sup>403</sup>

29:27-28 Shemaiah also reproved Zephaniah for not rebuking Jeremiah since Jeremiah had written the exiles encouraging them to settle down in Babylon (vv. 4-7).

This pericope does not record what the Lord said would happen to Shemaiah because he had done what he did; verse 25 has no apodosis. We must assume that divine judgment

<sup>399</sup>W. L. Holladay, *Jeremiah*, 2:143.

<sup>400</sup>Thompson, p. 549.

<sup>401</sup>Zephaniah ben Maaseiah consulted Jeremiah twice for King Zedekiah (21:1: 37:3). He was then or later became the priest who was second in command in the temple (52:24). He went into captivity in 586 B.C. and suffered execution in Babylon (52:24-27; 2 Kings 25:18-21). Jehoiada had evidently replaced Pashhur, who may have been taken to Babylon as an exile (cf. 20:1-6).

<sup>402</sup>The Hebrew word translated "iron collar" occurs only here in the Old Testament. Its meaning is somewhat obscure, though it probably describes some type of restraining device.

<sup>403</sup>Scalise, p. 79.

would come on him. The main reason for this pericope is to expose the wicked advice Shemaiah was giving, not to explain the judgment he would receive. The next pericope tells what would happen to Shemaiah.

### **Jeremiah's second letter to the exiles 29:29-32**

After Zephaniah had read Shemaiah's letter to Jeremiah (v. 29), the Lord moved Jeremiah (v. 30) to write a second letter to the exiles (vv. 31-32).

29:29            Zephaniah the priest read Shemaiah's letter to Jeremiah.

29:30            Then the Lord gave a message to Jeremiah. He was to tell the exiles that because Shemaiah had prophesied falsely, Yahweh would punish Shemaiah and his descendants. The Lord would cut off his family line, and Shemaiah would not live to see the good that Yahweh would do to His people.<sup>404</sup> Shemaiah's prophesying constituted advocating rebellion against Yahweh.

Chapters 26—29 all record the terrible consequences of rejecting the word of the Lord that one of His faithful servants, the true prophets, announced.

## **C. THE BOOK OF CONSOLATION CHS. 30—33**

This section of the Book of Jeremiah is a collection of prophecies that focus on the hope that lay before the Israelites. To this point in the book the emphasis has been mainly on judgment to come, though we have seen occasional promises of restoration (23:1-8; 24; 29). Here the emphasis changes from negative warnings to repent to positive promises of a glorious future. This section of the book, then, is similar to Isaiah 40—66 and Hosea 1—3, which also contain comforting promises of future blessing.

"At this point in the book of Jeremiah, over half has been the recording of the prophet's message of 'pluck up and . . . break down' (1:10). It is not surprising, therefore, that such an intense, though relatively unlengthy, concentration of the bright message of 'build and . . . plant' (1:10) should appear."<sup>405</sup>

"The content of the Book of Consolation repeatedly deals with the relationship between present suffering, further danger, and future salvation."<sup>406</sup>

### **1. The restoration of all Israel chs. 30—31**

Two things mark these first two chapters of the Book of Consolation, one having to do with content and the other with style. Most of the dozen or so prophecies in this section deal with the Northern Kingdom, as is clear from the names of people and places in the

<sup>404</sup>Compare Jeremiah's words of judgment on Hananiah (28:15-16).

<sup>405</sup>Jensen, p. 85.

<sup>406</sup>Scalise, p. 83.

text. Many scholars believe that Jeremiah wrote most of these prophecies, though not all of them, earlier in his ministry, probably during the reign of King Josiah (627-609 B.C.), when the Babylonian invasion was not so threatening. Others believe Jeremiah wrote them shortly before the destruction of Jerusalem (cf. 32:1; 33:1).<sup>407</sup>

Stylistically, most of the prophecies in this section are poetical. In contrast, all of them in the next section (chs. 32—33) are in prose. The form of composition as well as the content evidently guided the writer and or editor(s) as they put the book in its final form.

### **The superscription 30:1-3**

- 30:1-2        The Lord instructed Jeremiah to write all the messages that He had given the prophet in a book.
- 30:3         There needed to be a permanent record of these predictions since the people rejected the Lord's words. When He restored the fortunes of Israel and returned the people to their land the book would vindicate His faithfulness. It would also vindicate His predictions of judgment to come.

### **Jacob's distress and deliverance 30:4-11**

- 30:4         This oracle concerns all the Israelites, those of both the Northern and Southern Kingdoms.
- 30:5-6       A time of great terror, dread, and unrest was coming. Men would behave as though they were in labor; they would hold themselves in pain as women do when they are about to give birth. This is a picture of powerlessness and panic.
- 30:7         A coming time would be the worst Jacob had ever experienced or would ever experience. This anticipates the Tribulation in which Israelites will suffer more greatly than they ever have or ever will (cf. 46:10; Isa. 2:12-21; 13:6; 34:1-8; Ezek. 30:3; Dan. 9:27; 12:1; Joel 1:15; 2:1-2, 11; Amos 5:18-20; Mic. 1:2-5; Zeph. 1:2—3:8; Zech. 14:1-8, 12-15; Matt. 24—25; Rev. 6—18). Perhaps the Lord referred to His people here as Jacob because the patriarch Jacob experienced many extreme distresses. However, the Israelites would not perish in this distress because the Lord promised them deliverance, both physical and spiritual (cf. Zech. 12:10—13:1).
- 30:8-9       At that time Yahweh would set His people free from all those who restrained and enslaved them (cf. Exod. 7:16). The Israelites were not slaves in Assyria or Babylon. This points to a future deliverance (cf. Ezek. 34:23; Hos. 3:5). Instead they would serve their God and David their king, whom the Lord would raise up for them. This probably refers to a

---

<sup>407</sup>Liberal interpreters usually date this material after the exile.

successor to David rather than King David himself (cf. 23:5; Isa. 55:3-5; Ezek. 34:23-25; 37:24-25; Hos. 3:5).<sup>408</sup>

"The Targum, though interpretative, is correct in identifying this ideal King as 'Messiah, the son of David.' Among the Jews the name David came to be used of royalty, much as Pharaoh, Caesar, or Czar, but only in the highest and final sense."<sup>409</sup>

"They [verses 8-9] deal with the whole people of Yahweh in messianic times."<sup>410</sup>

In view of later revelation, we know that this successor to David is Jesus Christ (Luke 1:69; Acts 2:30; 13:23, 34, 38).

30:10 The Lord promised to save His people from afar and their descendants from the land of their captivity. Therefore they should not fear or be dismayed. The Israelites would return to their land where they would enjoy lasting peace and security. This will happen in the Millennium.<sup>411</sup>

30:11 The Lord would chasten His people with punishment for their sins, but He would not destroy them completely. He would, however, completely destroy the nations that had oppressed them in their captivity (cf. 46:27-28; Isa. 41:8-10; 43:1-6; 44:2-5).

"These passages cannot refer to the destruction of Jerusalem in A.D. 70, for the Davidic monarchy was not restored after that date and the Jews were not saved out of it, but were killed by the thousands and many were carried away."<sup>412</sup>

### **The healing of Zion's incurable wounds 30:12-17**

30:12-15 Yahweh had inflicted His people with a wound from which they could not recover because they had sinned greatly. No one could intercede effectively for them because the Lord had determined to punish them. Israel's political allies had forsaken her and would not help her. Even crying out would not help them.

30:16 Nevertheless, the Lord would turn the hostility of Israel's enemies back on themselves and punish them with the punishment they had inflicted on His people.

---

<sup>408</sup>Dyer, "Jeremiah," p. 1168, viewed this as referring to David himself (cf. Ezek. 34:23-24). He later wrote, in *The Old . . .*, p. 618, that it could refer to David or to Christ.

<sup>409</sup>Feinberg, p. 561.

<sup>410</sup>Thompson, p. 556.

<sup>411</sup>Amillennial interpreters view these predictions as describing spiritual conditions that believers enjoy presently and or eternal blessings that we will enjoy in heaven. See Kidner, pp. 103, 105.

<sup>412</sup>Kaiser, p. 112.



30:17 He would restore the Israelites to health and heal their wounds (cf. Isa. 53:5). Part of the reason for His salvation would be the nations' charge that Yahweh had forsaken His people.

### **The restoration of Jacob 30:18-22**

30:18 Yahweh promised to restore Israel's tribal fortunes (cf. Num. 24:5-6), to have compassion on His peoples' towns and homes, and to rebuild Jerusalem and the royal palace there.

30:19 Thanksgiving and merrymaking would mark the people. The Lord would increase their numbers and honor them.

30:20 Their children would be secure and happy, as they were before God judged the people. The people as a whole would again be stable, and the Lord would punish their oppressors.

30:21 Their leader would be one of them, not a foreign ruler who imposed his rule on them. The Lord would draw this leader to Himself, would call Him to His place of service. Approaching Yahweh was a priestly prerogative, so this verse may hint at the future ruler's priestly as well as His kingly function (cf. Ps. 110:4; Zech. 6:13).

"The ruler will need no mediator. Thus he will be greater than even David and Solomon. Like Melchizedek he will have a dual role. No man can take to himself the office of priesthood (cf. Heb 5:4). In fact, it was dangerous for even a king to do so (cf. Jeroboam in 1 Kings 12:26-33; 13:1-6; and Uzziah in 2 Chron 26:16-20). . . . Here is a reiteration of the promise to restore the Davidic line (cf. v. 9). . . . The Targum, though interpretative, is correct in its rendering 'Messiah shall be revealed to them out of their own midst.'"<sup>413</sup>

30:22 Israel and Yahweh would again be in covenant relationship as people and God (cf. 7:23; 11:4; Gen. 17:7; Exod. 6:7; Lev. 26:12; Deut. 7:26; Isa. 35; Ezek. 36:28).

### **The divine judgment 30:23—31:1**

30:23-24 The Lord's wrath would break forth on the wicked like a severe storm. It would not slacken until the Lord accomplished all His purpose (cf. 23:19-20). Therefore the carelessly sinful should feel no false sense of security from these promises of future pardon.

---

<sup>413</sup>Feinberg, p. 564.

The people did not understand this prophecy fully when the prophet first gave it, but they would in the far distant future. Similarly, God told Daniel to seal up his prophecy because it was not time for His people to understand it yet (Dan. 12:4, 9).

- 31:1 At that future time, the Lord would establish an intimate relationship between Himself and all the families of His people (cf. Gen. 17:7; Zech. 12:11-14). He would finally achieve what His people had always frustrated by their sins.

This verse concludes the material in chapter 30 and serves as a heading for chapter 31. All of chapter 31 describes the national restoration of Israel.<sup>414</sup>

### **Israel rebuilt and planted by a loving God 31:2-6**

- 31:2 When the Israelites would seek rest from the attacks of their enemies (cf. 6:16; Exod. 33:14; Deut. 3:20; Josh. 1:13, 15; 22:4; Isa. 63:14), they would find it in the wilderness (cf. 2:2; Rev. 12:14-16).<sup>415</sup> They will find refuge in the wilderness in the Tribulation, as they did following the Exodus (cf. Exod. 14:5-23; 33:14; Num. 14:20). But Israel's ultimate rest will occur in the Millennium when they rest in the Promised Land.

- 31:3 Assurance of future salvation rests on Yahweh's eternal commitment and His loving election of Israel (cf. Exod. 19:5-6; Deut. 7:9). He had loved it "from afar" in the wilderness following the Exodus, and He would love it "from afar" in the Exile. "Love" and "faithfulness" are both strong covenant terms.

"It is the LORD's constant commitment to Israel that bridges the generations and makes restoration possible."<sup>416</sup>

- 31:4 The Lord would rebuild His people into a nation that was His uniquely. He would see her just as appealing as in the time she departed from Egypt, like a virgin. Joy and rejoicing would return to the Israelites who would, however, first experience a silencing of their joy in exile (7:34; 16:9; 25:10).
- 31:5 They would return to Samaria and resume their agricultural pursuits, which the Lord, not Baal, would bless with fertility.
- 31:6 Watchmen in the Northern Kingdom would again summon their fellow countrymen to make pilgrimages to God's chosen city, Jerusalem, to

---

<sup>414</sup>This is verse 25 of chapter 30 in the Masoretic Hebrew Bible, and verse 31:2 begins the next chapter.

<sup>415</sup>Another view sees this as a reference to the captivity of the Northern Kingdom (cf. Hos. 2:14-15; e.g., Thompson, p. 566).

<sup>416</sup>Scalise, p. 108.

worship Him there. Since the kingdom divided, the northern Israelites worshipped at Bethel and Dan, not at Jerusalem. Thus a reunited Israel is in view.

Verses 4-6 picture God's restoration of Israel as a time of renewed joy (v. 4), peace and prosperity (v. 5), and renewed commitment to Yahweh (v. 6).

"This restoration reverses at least six aspects of the judgment suffered by Israel and Judah: no resting place in exile, a nation torn down, celebrations silenced, vines and plants uprooted, watchmen announcing the invading conqueror, and the temple destroyed. The poem also introduces an Israel transformed from a desperate adulteress (4:30) to a joyful maiden on her way back to God."<sup>417</sup>

### **Israel's homecoming 31:7-14**

- 31:7 In the future the Israelites would sing joyfully among the chief nations where they dwelt. They would call on Yahweh to save the remaining remnant of His people. Calling on Him to do this would praise Him because He promised to save them (cf. Isa. 11:11; 28:5).
- 31:8 A great number of Israelites of all types would return to the Promised Land from all over the world, not just from the north where they went into Assyrian and Babylonian captivity. The disadvantaged as well as the able-bodied would come, even pregnant women and those about to give birth. If the Lord would bring even these dependent types of people back, there was hope for all (cf. Isa. 35:5-6).
- 31:9 They would return weeping tears of repentance and praying for the Lord's favor. He would lead them back tenderly, as a father deals with his firstborn son (cf. Exod. 4:22; Deut. 32:6; Luke 15:11-32), and would make the trip refreshing, pleasant, and safe.
- 31:10 The nations also needed to hear that Yahweh would re-gather the flock of people that He had scattered, namely, Israel.
- 31:11 The Lord would purchase His contrary people and set them free from those strong enemies who would hold them captive, as He did earlier in the Exodus (cf. Exod. 6:5; 15:13, 15; Deut. 7:8; 9:26; Isa. 35:8-10; 43:1; 44:22-23; 48:20).
- 31:12 Back in Zion the Israelites would rejoice greatly over the change that Yahweh had made in their condition. They would enjoy all types of bounty (cf. Isa. 58:11), and they would never languish again. The food and

---

<sup>417</sup>Ibid., pp. 109-10.

drink mentioned were staples in the Israelite diet. This must refer to eschatological blessing, since the Jews are presently languishing.

31:13-14 All ages of people would celebrate because the Lord would change their mourning and sorrow into comfort and rejoicing. The priests would enjoy great abundance of blessing, and all the people would find satisfaction in the Lord for His goodness.

Verses 12-14 may be referring to the eschatological banquet that will occur on earth at the beginning of the Millennium (cf. Isa. 25:6-10). Then the Israelites will appreciate Yahweh as their father (v. 9), shepherd (v. 10), redeemer (v. 11), and king (v. 12). They cannot describe conditions following the Israelites' return to the land after the Babylonian captivity, as is clear from Ezra, Nehemiah, Haggai, and Zechariah.

### **The end of Rachel's mourning 31:15-22**

31:15 The Lord described the Israelite mothers, under the figure of Rachel, weeping for their children who had died because of the Assyrian invasion.<sup>418</sup> Rachel was the mother of Joseph, the father of Ephraim and Manasseh, and Benjamin and so represented all the Israelites, from the north and the south. Ramah was a town about five miles north of Jerusalem that stood in Benjamin near the border between Israel and Judah. The exiles stopped at Ramah, and undoubtedly wept there, on their way to exile in Babylon (40:1).

"Rachel's life story sets her apart from the other Israelite ancestors. She alone had only a grave and never a home in the promised land (Jer 30:3). She died 'on the way' (Gen 35:19), and her last words express her sorrow (Gen 35:18). Not every mother will give up her own life for her child's (e.g., Jer 19:9; Lam 2:20; 4:10; 2 Kgs 6:28-29). Rachel's death in childbirth makes her deeply credible as an example of the profound extent of a mother's love. Rachel is a mother who does not forget her children (cf. Isa 49:15)."<sup>419</sup>

31:16-17 The Lord comforted "Rachel" by assuring her that her children would return from exile. All the work she had expended on them was not in vain. There was hope for their future.

31:18 Yahweh heard Ephraim, the people of the Northern Kingdom, acknowledging that He had chastened them like an untrained calf. They cried out to Him to restore them because He was their God.

---

<sup>418</sup>The figure appears again in Matt. 2:17-18 where Rachel, the symbolic mother of all Israelites, weeps for the children that Herod the Great slew. See Dyer, "Jeremiah," p. 1170, for a brief discussion of Matthew's use of this figure.

<sup>419</sup>Scalise, p. 119.

- 31:19 Ephraim repented and felt humiliated and ashamed of his previous youthful rebellion against the Lord. Slapping one's thigh, an onomatopoeic expression in Hebrew, was a common expression of remorse in ancient Near Eastern culture (cf. Ezek. 21:12).<sup>420</sup>
- 31:20 Yahweh still regarded the people of Ephraim as His dear son and delightful child. Even though He had rebuked him, He still remembered and yearned for him. He would surely have mercy on these people (cf. Hos. 11:1-4, 8-9).
- 31:21 The special object of Yahweh's love, Israel (cf. v. 4), should give attention to returning to the Promised Land (cf. Isa. 35; 40:3-5, 11; 41:18-20; 42:16; 43:1-7; 44:3-4; 49:9-13).
- 31:22 Israel had wandered from the Lord long enough, as a wayward daughter. He would bring a new thing to pass, namely, Israel's repentance and return to the land. The last line of this verse may have been a popular proverb describing something very unusual and unexpected. Some interpreters, following Jerome, have taken it as a prophecy about Mary's conception of Jesus, but this seems unlikely. Others view it as just a figure expressing security, here of Israel's security back in the land. Perhaps the expression points to something amazing and hard to believe that would happen without being explicit about what it would be. Still other interpreters believe the woman represents Israel and the man Yahweh, the point being that the woman who had formerly departed from her Husband would cling to Him in the future (cf. 2:20-21; Hos. 1—3). I prefer this view. Another view is that the woman, Israel, will become aggressive and will cling to and overpower warriors among the nations who will oppose her.<sup>421</sup>

"Two things are 'new,' which have not been seen before in the land: (1) Faithless Israel, who is called a whore in chap. 3, will be taken back by God, even though such a thing is never done (3:1-2). (2) Mourning will be turned to joy."<sup>422</sup>

### **The regathering of Judah 31:23-26**

- 31:23 Instead of Judah being a target for cursing in the future, as she became because of the Babylonian exile, she would be a subject of blessing. She would become a place where righteousness dwelt, a holy hill.
- 31:24-25 Judah would experience great unity at that time because the Lord would satisfy the previously weary residents and refresh those who formerly languished.

<sup>420</sup>See Pritchard, ed., p. 108.

<sup>421</sup>Wiersbe, p. 123. See Feinberg, p. 571, and idem, "Jeremiah 31:22: Proverb, Promise, or Prophecy?" *Bibliotheca Sacra* 123:492 (October 1996): 315-24, and 124:493 (January 1967):16-21, for further discussion.

<sup>422</sup>Scalise, p. 123.

31:26 Jeremiah awoke from the sleep in which he had received this encouraging revelation from the Lord feeling good. The revelation was positive, and it encouraged him. Perhaps since sleep is often symbolic of death (cf. Job 14:12; et al.), Jeremiah may also represent Judah that awakens to new life.<sup>423</sup>

### **Future fruitfulness 31:27-30**

31:27 Days would come when the Lord would fill the Promised Land with people and animals once again. The land had become desolate because of the exiles.

31:28 As Yahweh directed the breaking down of His nation, so He would oversee its building up.

31:29-30 In that time of future blessing people would no longer repeat a popular proverb that said that the children were bearing the consequences of their fathers' sins. This proverb expressed a popular misconception (cf. Deut. 24:16; Ezek. 18:25). It blamed present trouble on past ancestors inordinately. In that day everyone would bear the consequences of his own actions. Justice would be obvious then whereas at present it did not seem to be operating. Whereas people do suffer for the sins of their ancestors to a limited extent (corporate responsibility), they much more consistently suffer for their own sins (individual responsibility).

### **The New Covenant 31:31-34**

Many commentators believe that Jeremiah's revelation of the New Covenant was his greatest theological contribution. They view it as the high point of the book, the climax of the prophet's teaching.

"The prophecy of Jeremiah marks a watershed in Hebrew religious and cultic life. From this point onwards there is a significant divergence between what has obtained in the past and what will characterize the future religious observances of Israel."<sup>424</sup>

31:31 In the future the Lord would make a new covenant with all the Israelites, specifically the Israelites who had inhabited the Northern Kingdom and those who had inhabited the Southern Kingdom (cf. 32:40; Ezek. 37:26; Luke 22:20; 1 Cor. 11:25; 2 Cor. 3:6; Heb. 8:8—9:28; 12:24).<sup>425</sup>

---

<sup>423</sup>Ibid., p. 129.

<sup>424</sup>Harrison, *Jeremiah and . . .*, p. 138.

<sup>425</sup>This is the only place in the Old Testament where the term "new covenant" appears, though there are references to it elsewhere.

"The short passage which develops from the simple announcement in this verse is one of the most important in the book of Jeremiah. Indeed it represents one of the deepest insights in the whole OT."<sup>426</sup>

31:32 This New Covenant would be different from the Mosaic Covenant, which the Israelites consistently and inevitably broke in spite of Yahweh's faithful commitment to them. They had worshipped Baal (Heb. *ba'al*) even though Yahweh had been a faithful husband (Heb. *ba'al*) to them.

31:33 Instead of God's law being external to them, the Lord would write it on their heart (i.e., mind and will; cf. 17:1). He would do something for them that they could not do for themselves (cf. Deut. 30:5-6). Writing on the heart suggests the removal of written documents and merely human mediators. Having the Lord's word in the heart prevents sin and fosters obedience (cf. Deut. 11:18; Ps. 40:8; 119:11).

"It will become part of the nature of God's people; it will be *instinctive*. The core of the new covenant is God's gift of a new heart (cf. Ezek 36:25-27). Herein lies the sufficient motivation for obeying God's law."<sup>427</sup>

God would also enter into intimate relationship with His people as His covenant partners (cf. 7:23; 11:4; 24:7; 30:22; 31:1; 32:38; Deut. 31; Ezek. 11:20; 36:28). The old Mosaic Covenant being broken, a new relationship would begin.

"If the sheer grace of God's election of Israel as covenant partner was apparent in the first covenant making, how much more so in this promise following their history of unfaithfulness and rebellion (v 32)."<sup>428</sup>

Notice that Jeremiah revealed nothing about human responsibility under the New Covenant. That would come later with the teachings of Jesus Christ and the apostles.

31:34 All the Israelites, from the least to the greatest, would also know the Lord intimately, without having to be exhorted to do so.

"The verb *know* here probably carries its most profound connotation, the intimate personal knowledge which arises between two persons who are committed wholly to one another in a relationship that touches mind, emotion, and

---

<sup>426</sup>Thompson, pp. 579-80.

<sup>427</sup>Feinberg, "Jeremiah," p. 576. Italics mine. Cf. Wiersbe, p. 123.

<sup>428</sup>Scalise, p. 133.

will. In such a relationship the past is forgiven and forgotten."<sup>429</sup>

They would know Him in this intimate way because He would forgive their sins and not bring them to memory or judgment any more. True forgiveness, in contrast to the covering of sin that the Old Covenant sacrifices provided, would make intimacy with God possible.

"The old covenant spoke of a great physical deliverance from Egypt through the blood of lambs and the power of God; the new covenant proclaims a great spiritual deliverance from sin and death through the efficacious blood of the Lamb of God and the power of God. The Passover Feast memorialized the first; the Lord's Supper memorializes the second."<sup>430</sup>

There are three basic views concerning the identity of the people with whom God would make this new covenant and when He would make it. One view is that God will make it with Israel alone when He resumes dealing with that nation as formerly, namely, in the Millennium (cf. Rom. 11). Another view is that God made it with the church alone, which advocates of this view (i.e., covenant theologians) say replaces Israel in God's plans, and he made it at the Cross. A third view is that God made it with Israel at the Cross, and the church, which does not replace Israel, somehow enters into its blessings.

I hold the third of these views. It seems to me that God made the New Covenant with Israel when Jesus Christ died on the cross (Luke 22:20). The church now operates under this covenant (1 Cor. 11:25; 2 Cor. 3:1-14; Heb. 8:8-12; 10:16-17).<sup>431</sup> However, Israel will enter into the blessings of this covenant, which God promised her, at the time of Israel's restoration, namely, at the second coming of Christ.<sup>432</sup>

---

<sup>429</sup>Thompson, p. 581.

<sup>430</sup>Feinberg, "Jeremiah," p. 575.

<sup>431</sup>The Apostle Paul pointed out seven contrasts between the Old and New Covenants in 2 Cor. 3:6-11. See other comparisons of the two covenants in Heb. 8:8-13; 9:15-28; 10:15-18, 28-29; and 12:18-24. E. W. Hengstenberg, "The New Covenant," in *Classical Evangelical Essays in Old Testament Interpretation*, pp. 237-51, argued that the differences between the old and new covenants were only matters of degree, but this view fails to recognize the profound differences between these two covenants.

<sup>432</sup>See John F. Walvoord, "The New Covenant," in *Integrity of Heart, Skillfulness of Hands: Biblical and Leadership Studies in Honor of Donald K. Campbell*, pp. 186-200; J. Dwight Pentecost, *Thy Kingdom Come*, pp. 164-77; Rodney J. Decker, "The Church's Relationship to the New Covenant," *Bibliotheca Sacra* 152:607 (July-September 1995):290-305; Bruce A. Ware, "The New Covenant and the People(s) of God," in *Dispensationalism, Israel and the Church*, pp. 68-97; Craig A. Blaising, "The Fulfillment of the Biblical Covenants," in *Progressive Dispensationalism*, pp. 179-211. John R. Master, "The New Covenant," in *Issues in Dispensationalism*, pp. 93-110, argued for two new covenants, one with Israel and one with the church, as did L. S. Chafer, *Systematic Theology*, 4:325. See also Charles C. Ryrie, *The Basis of the Premillennial Faith*, pp. 105-25.



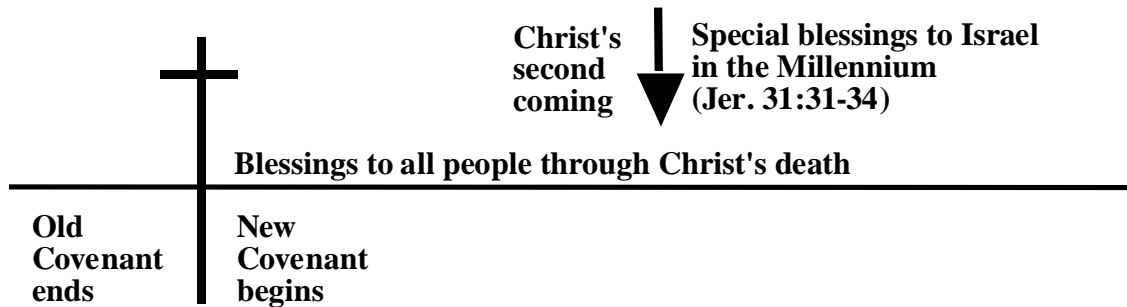

This arrangement resembles one that is possible to set up in a Charitable Lead Unit Trust under the Internal Revenue Code of the United States. Suppose there was a vastly wealthy and generous philanthropist of the magnitude of a Bill Gates. As he prepared his will he bequeathed millions of dollars to various charitable causes that would benefit millions of people all over the world when he died. He also wrote into his will that when his only son reached the age of 21 he would inherit billions of dollars. When this man died, his son was only five years old, so for 16 years he did not enter into his father's inheritance. However as soon as the philanthropist died the millions of dollars he had bequeathed to charity went to work immediately to help many people.

This illustration shows how the church enters into the blessings of the New Covenant. When Christ established the Lord's Supper it was as though He notarized His will; it became official then. The will is the New Covenant. When He died His "estate" became available to those He chose to profit from it, namely, both Jewish and Gentile believers in Jesus Christ. Soon many people around the world, Jews and Gentiles in the church, began to benefit from the blessings of His death. However God's chosen people, His son Israel, will not enter into his unique inheritance until the appointed time, namely, the Millennium. Blessings for the church began almost immediately after Christ's death. Blessings for Israel will not begin until God's appointed time arrives.

"Perhaps an[other] illustration will help us better understand this dual fulfillment of the new-covenant prophecy. Standing with Jeremiah and Ezekiel at their vantage point in history, we are in a dark tunnel. As we look with them toward the light at the end of the tunnel, we see God making a new covenant with ethnic Israel. We then move through the tunnel and emerge into the light. There ahead of us we see the same scene we saw from afar—God implementing his covenant with ethnic Israel. But now that we have stepped out of the tunnel into the light, our peripheral vision is expanded. To the side of us, incapable of being seen from back in the tunnel, is another scene—God implementing this same covenant with the church of the present era, comprised of both Jews and Gentiles. The prophets were not wrong—they simply had 'tunnel vision' because their focus was on ethnic Israel."<sup>433</sup>

<sup>433</sup>Chisholm, *Handbook on . . .*, p. 196.

Which blessings of the New Covenant does the church enjoy now and which are for Israel in the future? There are four promises in verses 33 and 34. The promise of having God's law written on the heart has been fulfilled to a limited extent. Christians do have an innate desire to please God because of the indwelling Holy Spirit's ministry, but we do not have the innate understanding of God's will that God promised here since that was a promise for the Israelites. All people do not know the Lord, from the least to the greatest, now. Second, we have a unique covenant relationship with God as Christians, but it is not the same covenant relationship that God promised the Israelites here. Third, all Christians know the Lord to some degree of intimacy now, but we do not all have the depth of relationship with God that He promised the Israelites here. We still need teaching and teachers, but this will not be the case for Israel in the future. Fourth, Christians enjoy the complete forgiveness of sins, as the Israelites will in the future. So I would say we enjoy all these blessings to some extent, but not to the extent Israel will enjoy them in the future. We may enjoy the last promise just as the restored Israelites will. As the return from exile was a partial fulfillment of the promises of restoration, so the church's enjoyment of these blessings is only a partial fulfillment of what God promised Israel.<sup>434</sup>

The New Covenant is a branch of the Abrahamic Covenant. In the Abrahamic Covenant, God promised Abraham a piece of real estate for his descendants, an incalculable number of descendants, and blessing for his descendants and for all people through his descendants (Gen. 12:1-7; et al.). Deuteronomy 29—30, sometimes called the Palestinian Covenant, gave more information about the land God had promised to Abraham. The Davidic Covenant gave more information about God's promises regarding descendants (2 Sam. 7). The New Covenant revealed the particulars of the promised blessing (Jer. 31). Each of these later covenants relates to the Abrahamic Covenant organically; each is an outgrowth of it in the progress of revelation. In contrast, the Mosaic (Old) Covenant does not relate organically but "was added" (Gal. 3:19) to explain how the Israelites could maximize the benefits God had promised in the Abrahamic Covenant. Consequently when God terminated the Old Covenant it did not eliminate anything He had promised in the Abrahamic, "Palestinian," Davidic, or New Covenants.<sup>435</sup>

### **Permanent restoration 31:35-37**

- 31:35           The Lord reminded His people that He was the one who controlled the course of nature, not Baal. It operated regularly and within His set limits, as He promised Noah it would (cf. Gen. 8:22; 9:8-17). The sun and moon do not vary from their positions, but the sea appears to operate chaotically, yet the Lord controls them all.
- 31:36           Future Israel would no more cease from being a special nation in God's sight than the fixed order of nature would cease. This is strong testimony that the church has not replaced Israel in God's plans.

<sup>434</sup>See also Dyer, in *The Old . . .*, p. 620.

<sup>435</sup>I have put "Palestinian Covenant" in quotation marks because Deut. 29—30 does not contain all the features of a typical ancient Near Eastern covenant, as the other covenants mentioned do. Some authorities prefer to view these chapters as simply more information about the land promises in the Abrahamic Covenant.

31:37 If people could thoroughly explore the heavens above or the earth beneath, then the Lord would cast off future Israel because of her sins.

"Looking beyond national Israel for the fulfillment of this prophecy in the church, as a spiritual Israel, fails to grapple with the certainty of the statements in Jeremiah 31:36-37."<sup>436</sup>

### **The new Jerusalem 31:38-40**

31:38-39 In the future, Jerusalem would undergo rebuilding for the Lord. It would be built larger than it had been before its destruction by the Babylonians. The tower of Hananel was at the northeast corner of the city (Neh. 3:1; 12:39; Zech. 14:10), and the Corner Gate seems to have been on the northwest side of Jerusalem (2 Kings 14:13; 2 Chron. 26:9; Zech. 14:10). The locations of the hill Gareb and Goah are unknown, but they may have been on the west side since this would fill out the picture of the city.

31:40 The whole new, enlarged city would be devoted to Yahweh, and it would never experience invasion or overthrow again. The valley of the dead bodies probably refers to the Hinnom Valley to Jerusalem's south and west (cf. 7:31). The brook Kidron lay on Jerusalem's east side, and the Horse Gate stood at the southeast corner of the city wall and led out to the Kidron Valley. What had formerly been unclean land, full of dead bodies, would be holy to the Lord. The city's change in character would be even more remarkable than its change in size.

"Since a literal nation must have an actual geographical location in which to reside, it is now revealed that the capital, Jerusalem, will be rebuilt and expanded—yes, the very city that Jeremiah was before long to see destroyed by the Chaldean army."<sup>437</sup>

The description of rebuilt Jerusalem in Nehemiah's day does not coincide with this picture. Furthermore the temple that the restoration community rebuilt did not continue to exist (cf. v. 40); the Romans destroyed it in A.D. 70. That this is a description of a heavenly city is unlikely in view of the large amount of literal detail. Contextual considerations also demand an eschatological rebuilding of the city on the ancient site. Ezekiel 40—48 and Zechariah 2 and 14 also describe this future city.

## **2. The restoration of Judah and Jerusalem chs. 32—33**

The second part of the Book of Consolation (chs. 30—33) is entirely prose material, not mainly poetry as were chapters 30—31. It describes conditions just before the fall of Jerusalem, not conditions quite a while before then (chs. 30—31). And it deals mainly

<sup>436</sup>Kaiser, p. 113.

<sup>437</sup>Feinberg, "Jeremiah," p. 579.

with the future restoration of Judah and Jerusalem, not that of the Northern Kingdom (chs. 30—31).

### **A challenge to Jeremiah's faith ch. 32**

All of chapter 32 centers around one event in Jeremiah's life. By this time he had given many prophecies about the restoration of Israel to her land. Something happened that challenged his faith in those promises. The chapter records what happened and how the prophet responded.

#### **Jeremiah's purchase of land 32:1-15**

This was another of Jeremiah's symbolic acts (cf. 16:1-4; 18:1-12; 19:1-2, 10-11; 27:1—28:17; 43:8-13; 51:59-64).

- 32:1            A message came to the prophet from the Lord about 587 B.C., the year before Jerusalem fell.
- 32:2            Jerusalem was then under siege by the Babylonians, and Jeremiah was imprisoned in the court of the guard somewhere in the palace complex. This appears to have been a guarded yard similar to a modern prison yard.<sup>438</sup>
- 32:3-5          King Zedekiah had imprisoned Jeremiah for preaching in the Lord's name that Yahweh was about to turn Jerusalem over to Nebuchadnezzar who would take possession of it. Zedekiah would not escape, Jeremiah had said, but would face Nebuchadnezzar who would take him captive to Babylon (cf. 2 Kings 25:4-7). There he would remain until the Lord visited him, evidently with death. Jeremiah had preached that fighting against the Chaldeans would be fruitless, which sounded like treason.
- 32:6-7          The Lord told Jeremiah that his cousin Hanamel would offer to sell him a field in Anathoth, Jeremiah's hometown, just a few miles northeast of Jerusalem.<sup>439</sup> Jeremiah had the right to buy it according to the laws of redemption (Lev. 25:25-31; cf. Ruth 4:1-12).
- 32:8            Sure enough, Hanamel visited his cousin in prison and made Jeremiah the offer, confirming the Lord's message. Hanamel probably wanted to sell his property before he left the land as an exile. The handwriting was on the wall and he could read the signs of the times. To try to sell a piece of confiscated property to a relative in prison reflects insensitivity at best and total contempt at worst. He was offering to sell Jeremiah a piece of the battlefield! Perhaps Hanamel was one of those kinsmen that the Lord told Jeremiah would hate him (cf. 11:19-23; 12:6).

<sup>438</sup>Chapters 37—38 provide more historical background.

<sup>439</sup>Hanamel's name does not appear elsewhere in the Old Testament.

". . . was there ever a more insensitive prison-visitor?"<sup>440</sup>

This offer constituted a test of Jeremiah's faith in the promises of restoration that the Lord had given him and an opportunity to give witness to that faith. Anathoth was already in Babylonian hands when Jerusalem was under siege. Imagine being offered property to buy that you could not take possession of or had no hope of ever using!

32:9-10 Jeremiah bought the field for 17 shekels (about seven ounces) of silver. Since we do not know the size of the field or anything else about its condition, we cannot tell if this was a fair price. Jeremiah signed and sealed the deed with witnesses and exchanged the money with his cousin. This would have been viewed as a very foolish thing to do since the Babylonians had taken possession of all the land around Jerusalem by this time.

"Since the early, doubt-ridden days [15:18; 20:7] he has learnt, and still teaches the rest of us, to recognize the hidden hand of God in what befalls him, from whatever human quarter it may arise."<sup>441</sup>

32:11-12 Then Jeremiah gave the original purchase document and a copy of it to Baruch ("Blessed") in the sight of all the people who were present.<sup>442</sup>

32:13-15 Jeremiah instructed Baruch to store the documents in an earthenware jar, so they would last a long time.<sup>443</sup> The Lord had revealed to him that the Israelites would again buy and sell land in Judah. In spite of the imminent captivity, they would return to the land and resume life as usual eventually.

### Jeremiah's prayer 32:16-25

The prayer begins with a long ascription of praise to Yahweh (vv. 17-23) and concludes by expressing incredulity that the Lord had commanded His servant to buy the land in Anathoth (vv. 24-25; cf. Neh. 9:6-37; Dan. 9:4-19).<sup>444</sup>

32:16 Shortly after Jeremiah gave Baruch the purchase deed, he prayed to the Lord.

---

<sup>440</sup>Kidner, p. 112.

<sup>441</sup>Ibid.

<sup>442</sup>Archaeologists have unearthed similar duplicate deeds in the ancient Near East, one sealed and the other unsealed. See Harrison, *Jeremiah and . . .*, p. 141.

<sup>443</sup>These jars were undoubtedly similar to the ones in which the Dead Sea Scrolls were preserved and discovered two millennia later, still in fairly good condition. The jars were usually sealed with pitch.

<sup>444</sup>This prayer and the ones in Nehemiah 9 and Daniel 9 are similar in that they all contain praise, confession, and lament.

- 32:17-18 Citing God's creation of the cosmos as evidence that nothing was too difficult for Him, Jeremiah acknowledged God's extreme covenant loyalty and the justice of His punishment of Judah. Not even restoring Israel to her land and making the property in Anathoth valuable to the Israelites again was too difficult for Yahweh, Jeremiah believed.
- 32:19 God is wise and strong, fully aware of all that happens, and just in giving everyone what he deserves. This is a classic statement of how God judges: according to people's deeds, what they really do rather than what they intend or promise to do. The basis of divine judgment is human works (cf. John 6:29; Rev. 22:12).
- 32:20-21 Yahweh had established His reputation of being powerful in the Exodus both among the Israelites and among all people.
- 32:22 He had given the Israelites the good land of promise, as He had sworn to the patriarchs.
- 32:23 The Israelites had taken possession of the land but had not obeyed the Lord, either spoken messages from prophets or the written Torah (instruction). Consequently all the calamities that the Israelites were facing had come upon them.
- 32:24 Calamity had culminated in the siege of the city by the Babylonian soldiers. They were about to take it in fulfillment of what the Lord had warned His people about, but He was fully aware of present conditions.
- 32:25 Yet the Lord had commanded Jeremiah to buy the field in Anathoth even though the Chaldeans were ready to take Jerusalem.

Though Jeremiah did not ask for an explanation of the Lord's directions to him, that is the point of his prayer. He wanted an explanation for this unusual command. Did he have second thoughts after purchasing the property, did his faith waver, or was his prayer an expression of his faith?

"It is a fine example of the way to pray in a desperate situation: concentrating first on the creative power (17) and perfect fidelity and justice (18-19) of God; remembering next his great redemptive acts (20-23a; to which the Christian can now add the greatest of them all)—and then with this background, laying before God the guilt of the past (23b), the hard facts of the present (24) and the riddle of the future (25)."<sup>445</sup>

#### **Yahweh's reply to Jeremiah's prayer 32:26-44**

The Lord's response to the prophet's prayer assured him that He would indeed restore Israel to her land. Jeremiah had not made a mistake buying the property.

---

<sup>445</sup>Kidner, p. 113.

- 32:26-27 The Lord began His reply by affirming His universal deity and the fact that indeed nothing is too difficult for Him (cf. Luke 1:37). By restating Jeremiah's statement back to him as a question, the Lord was asking if he really believed it (v. 17).
- 32:28-29 He explained that He was about to turn over Jerusalem to Nebuchadnezzar who would burn all the places where the people had practiced idolatry, namely, throughout the city.
- 32:30-32 The Lord would do this because ever since the Israelites had built Jerusalem all of them had been practicing idolatry there. Solomon completed building the city, and he was the first of Israel's kings to practice idolatry.
- 32:33 The people had turned away from the Lord rather than seeking Him.
- 32:34-35 They had defiled the temple precincts by placing images of idols there and had built places of worship for Baal in the Hinnom Valley. They had even practiced child sacrifice there, something that Yahweh had not even imagined let alone commanded. The Lord's disclaimer hints that some of the people may have been claiming that child sacrifice fulfilled His law.<sup>446</sup>
- 32:36-37 Nevertheless the Lord promised to bring His people back into the land from which He was about to drive them. He would make them dwell securely in the city He was about to hand over to their enemy.
- 32:38-40 He would reestablish covenant relationship with them, give them all a faithful heart, and they would then always fear Him (cf. 31:31-34). The result would be blessing for them and for their descendants. His (new) covenant with them would be everlasting, a promise not mentioned in the New Covenant passage in the preceding chapter (cf. Ezek. 36:24-32). He would always do them good, and they would always reverence Him, not just know Him (31:34).
- 32:41 It would please Him to bless them, and He would wholeheartedly return them to the land in faithfulness to His promise.
- 32:42 As surely as He had brought calamity on them, He would bring this blessing.
- 32:43-44 The land that then lay desolate would again see the buying and selling of property, as Jeremiah had just done. This would be true of the whole land that was then under siege, all of Judah. Yahweh would restore the fortunes of His people.

---

<sup>446</sup>Scalise, p. 159.

### The restoration of Jerusalem and Judah confirmed 33:1-13

- 33:1 Jeremiah received another message from the Lord while he was still confined in the court of the guard (cf. 32:2).
- 33:2 The Lord introduced Himself as the Creator and Establisher of the earth (cf. 32:17; Gen. 1). This was appropriate since He would say that He was going to do some things that required great power.
- 33:3 He commanded Jeremiah, and perhaps the people, to pray to Him with the promise that He would hear him and tell him inaccessible (Heb. *besuroth*) things that the prophet did not know (cf. Ps. 91:15). The Hebrew word *besuroth* describes something made inaccessible by fortifying or enclosing it, such as a city (cf. Num. 13:28; Deut. 3:5; 28:52; Ezek. 21:20). The Lord's plans for Israel were inaccessible to most people, but He would unlock some of these secrets and share them with Jeremiah in answer to the prophet's prayer. We must ask the Lord for some things before He will give them to us (cf. Matt. 7:7; James 4:2).

"While God is always ready to answer the cry of the human heart, man must first request assistance."<sup>447</sup>

"In other words, although God can make himself heard, and has already done so in saying this, nevertheless to reveal all that he wants to say, he desires a hearer who is already reaching out to him. This is why prayer is never superfluous to the study of Scripture or the quest for guidance. God is then speaking to an upturned face, not a preoccupied back."<sup>448</sup>

We may assume that Jeremiah, and perhaps the faithful remnant, prayed this prayer. What follows are incredible promises concerning the restoration of the nation, its rulers, and its worship leaders.

- 33:4 The Lord would do something to the city, which at this time was full of houses that the Jerusalemites had demolished to build up the city walls so the Chaldeans could not break through them. They had also used some of the palace wood and stone for this purpose (cf. 22:5).
- 33:5 The city was also full of Judahite corpses that had died in the siege. Really these people had died because the Lord was fighting against His people. He had not responded to their cries of help because of their wickedness.

---

<sup>447</sup>Harrison, *Jeremiah and . . .*, p. 143.

<sup>448</sup>Kidner, p. 114.



- 33:6 The Lord promised to bring health and healing to the city and to restore His people (cf. 30:17). He would bless them with much peace and truth in the future.
- 33:7 He would restore the fortunes of both the Northern and Southern Kingdoms and would rebuild these nations as they had been formerly.
- 33:8 He would cleanse them of their iniquities against Him, and He would pardon their sins and transgressions (cf. 31:34; 50:20; Ezek. 36:25-26).
- 33:9 Jerusalem would become a city associated with joy, praise, and glory in the thinking of all the world when people heard of all the good things that Yahweh had done for her. The nations would fear and tremble because of all the good and the peace that He would make for her.
- 33:10-11 Presently desolate Jerusalem and the cities of Judah would experience joy and thank God because He would restore their fortunes as they had been formerly.<sup>449</sup>
- 33:12-13 Judah would again become a quiet and secure place where shepherds would pasture their flocks. This may refer to leaders of people as well as to shepherds of sheep (cf. 23:1-3; Ezek. 34:1-6; Luke 15:3-7; John 10:1-18).<sup>450</sup>

### **The restoration of David's dynasty and the legitimate priesthood 33:14-26**

This section consists of a small collection of messianic prophecies.

- 33:14 Future days would come, the Lord promised, when He would fulfill His promises concerning the restoration of all Israel.

"The predicted restoration ('the days are coming') is not, however, to be looked for in the immediate time of the return from the Captivity. Only in a limited and preliminary way were these promises fulfilled in Zerubbabel and Sheshbazzar after the Captivity (cf. Ezra 1:8; 2:2; also 2:40-54; 8:15-20). Ultimately, they are combined in the highest sense in Christ (cf. Ps 110:4) and are yet to be fulfilled in the reign of Messiah on earth."<sup>451</sup>

<sup>449</sup>Verse 11 is the closing part of the benediction used in the modern Jewish wedding ceremony.

<sup>450</sup>The Targum interpretation substituted the word "Messiah" for the phrase "the one who numbers them."

<sup>451</sup>Feinberg, p. 591. See also Kaiser, pp. 114-16; and Jensen, p. 93. "Days are coming" (Heb. *hinneh yamim ba'im*) has appeared 16 times so far in Jeremiah referring to coming judgment on Judah and the surrounding nations. In the remaining nine occurrences of the phrase in the book, it points to a time of future blessing for Israel. See Dyer, "Jeremiah," p. 1176.

- 33:15 At that future time, Yahweh would cause a righteous Sprout from the Davidic line of kings to appear, a legitimate ruler. He would rule in justice and righteousness on the earth (not just in heaven; cf. 23:5-6).<sup>452</sup>
- 33:16 Then Judah would enjoy salvation, and Jerusalem would dwell in safety. The name of the city would be "Yahweh our righteousness." Formerly this was to be the name of a ruler (23:6), but it will also be the name of Jerusalem (cf. Ezek. 48:35).
- "The inference is that Jerusalem would so manifest the qualities of justice and righteousness (in contrast to her past bad record) that she would be worthy of such a name and exemplify the divine order for all the cities and all the people in Israel."<sup>453</sup>
- 33:17 From then on, there would always be a Davidic king ruling over the nation of Israel (cf. 1 Kings 2:4; 8:25; 9:5).<sup>454</sup>
- That King has appeared, but His subjects, the Israelites, refused to accept Him as their King. Therefore, He returned to heaven, but He will return to earth to rule over restored Israel in the future, at the Second Coming. Christ's present rule over the church today from heaven is not the same rule as the one promised here. The one promised here is a reign over the Israelites at the time of their future restoration.<sup>455</sup>
- 33:18 Likewise the Levitical priests would resume functioning and would continue to do so forever.<sup>456</sup> They would offer sacrifices of worship continually (in the millennial kingdom). The burnt and grain (or meal) offerings were primarily for worship rather than to remove the defilement of sin (cf. Lev. 1—2).<sup>457</sup> In Jeremiah's day, the priesthood was corrupt, and it may even have included non-Levitical priests (cf. 6:13; 19:1; 26:10-11). The lack of legitimate priests was a problem in the early years of the restoration community (cf. Ezra 8:15).

---

<sup>452</sup>Other messianic passages in Jeremiah picture Him as the fountain of living waters (2:13), the good Shepherd (23:4; 31:10), the Lord our righteousness (23:6), David the king (30:9), and the Redeemer (50:34).

<sup>453</sup>Thompson, p. 601.

<sup>454</sup>See Douglas K. Stuart, "The Prophetic Ideal of Government in the Restoration Era," in *Israel's Apostasy and Restoration: Essays in Honor of Roland K. Harrison*, pp. 283-92.

<sup>455</sup>Covenant premillennialists and "progressive" dispensationalists take a slightly different position. They believe that Christ's present rule from heaven is the first phase of His reign as the Davidic King, and the second phase will begin with His return to the earth to rule over Israel and the whole world. For further discussion of this view, see Craig A. Blaising, "The Kingdom of God in the New Testament," in *Progressive Dispensationalism*, pp. 257-62, 282.

<sup>456</sup>This verse and the ones that follow are the only references to the restoration of the legitimate priesthood in the book.

<sup>457</sup>The Levitical priests will worship God under the New Covenant. The Old (Mosaic) Covenant came to an end at the Cross.

In the Millennium there will be a restoration of Levitical priests, though instead of looking forward to the coming of the ultimate Sacrifice the worship will look back to it.<sup>458</sup>

33:19-21 This promise of the restoration of a Davidic king and of Levitical priests would be as certain as the Lord's promise that day would follow night forever (cf. 31:35-36; Gen. 1:5, 14-18; 8:22; Num. 25:12-13; Deut. 4:19; Ps. 19:1-6; 136:7-9).

33:22 Yahweh promised to multiply the descendants of David and the Levites as the stars of the heavens and as the sand of the sea (cf. Gen. 13:16; 15:5; 22:17).

"Just as the covenant with Noah (cf. Gen 8:22) is kept, so the covenant with David (cf. 2 Sam 7) and that with Levi (Num 17) will also be kept."<sup>459</sup>

33:23-24 The Judahites had concluded that Yahweh had rejected the two families of the Israelites: the Northern and Southern Kingdoms (cf. 30:3). They were saying that there was no future for them as nations.

33:25-26 But Yahweh promised that He would restore the fortunes of Jacob's seed and that a descendant of David would rule over all the Israelites in the future. This promise was as sure as God's promise to provide day and night faithfully. The Lord's compassion prevented Him from abandoning His chosen people and gave hope for their restoration.

"The greatest argument for the future restoration of Israel as a nation is the character of God. He made a series of covenants with the patriarchs, David, and the Levites; His character demands that He will ultimately fulfill these promises to their nation."<sup>460</sup>

"The salvation announcements in chap. 33 answer at least two questions left from chap. 32 (and 30—31): (1) How can people who persistently rebelled and even offered their children to Molech, become covenant partners with God? The LORD will heal, cleanse, and forgive them (vv 6-8) out of mercy for them (v 26). (2) What will life be like for the people whom God will plant in the land? Families will grow again (v 11), worship will resume at the temple (vv 11, 18), and God will always

---

<sup>458</sup>The Lord Jesus gave the church the Lord's Supper only until He would return. Amillennialists believe that this promise of the restoration of Levitical worship finds fulfillment in the present spiritual worship of the church (the symbolic meaning of Jerusalem here) and or that it anticipates heavenly worship. See, for example, Harrison, *Jeremiah and . . .*, p. 145; or Kidner, p. 115.

<sup>459</sup>Feinberg, "Jeremiah," p. 592. See also Lev. 25:12-13.

<sup>460</sup>Dyer, "Jeremiah," p. 1177.

provide a legitimate and righteous ruler (vv 14-26), so that people can live in safety (v 16). All this will be accomplished by the Creator, for whom nothing is too difficult (32:17, 26) and whose willingness and power to do good inspires awe among the nations (33:9)."<sup>461</sup>

#### **D. INCIDENTS SURROUNDING THE FALL OF JERUSALEM CHS. 34—45**

The Book of Consolation contained messages of future hope for Judah (chs. 30—33). Now Jeremiah returned to document her present judgment. Chapters 34—45 continue the theme of judgment on Judah and Jerusalem from chapters 2—29.

All the events and messages contained in these chapters date near the fall of Jerusalem, which happened in 586 B.C. As mentioned previously, the Book of Jeremiah follows a generally chronological arrangement, but within various sections of the book the material is not always completely chronological. Jeremiah is unique among the prophetic books in that it records the fulfillment of its own prophecies about the fall of Jerusalem and the beginning of the Exile.

#### **1. Incidents before the fall of Jerusalem chs. 34—36**

The events recorded in these chapters took place during the siege of Jerusalem, which lasted from about 589 to 586 B.C. During this period, there was a break in the siege. The Babylonians heard that Pharaoh Hophra (589-570 B.C.) was leading an army into Palestine from Egypt, probably in 588 B.C. (cf. 37:6-11; 44:30). The Babylonian army went to meet the Egyptian army, but the Egyptians returned home without joining battle. During this time Jerusalem enjoyed a respite from its siege. The material in this section of the book is again biographical.

#### **The announcement of Zedekiah's fate 34:1-7**

"The Book of Consolation has ended, and 34:1 confronts its readers with the full force of the invading imperial army. The destruction of Jerusalem and the remainder of Judah seems inevitable (v 3) because the LORD has made Nebuchadnezzar ruler over all the nations and because burning with fire is a fitting consequence for their deeds. . . .

"This unit serves to direct the readers' attention to the issue of obedience to the LORD's word as it is explored in 34:8-22 and chaps. 35—36."<sup>462</sup>

34:1            The following message came to Jeremiah when Nebuchadnezzar and his large army were besieging Jerusalem (cf. 21:1-10). Zedekiah's rebellion against Babylon in 589 B.C. had instigated the siege (2 Kings 24:18-20—25:1; Ezek. 17:11-21).<sup>463</sup> The vassal nations under Nebuchadnezzar's

<sup>461</sup>Scalise, p. 175.

<sup>462</sup>Ibid., p. 181.

<sup>463</sup>This incident antedates the events recorded in chapters 32—33, however, because Jeremiah was not yet imprisoned.

suzerainty were bound to supply troops to assist him in his wars against his enemies, which they had done (cf. 2 Kings 24:2).<sup>464</sup>

"This verse underscores that the Nebuchadrezzar who now invades Judah is the same Nebuchadrezzar to whom the LORD, the creator, had granted authority over 'all nations,' and even the wild animals, for a time (27:6-7)."<sup>465</sup>

- 34:2 The prophet was to go to King Zedekiah and tell him that Israel's God was going to deliver Jerusalem to Nebuchadnezzar who would burn it (cf. 21:4-7; 2 Kings 25:6-7). His rebellion against Babylon's authority would not succeed.
- 34:3 Zedekiah would not escape but would be captured and would stand before Nebuchadnezzar face to face (cf. 39:5-7). He would also go to Babylon as a prisoner of war. All this came to pass (cf. 39:4-7; 52:7-11).
- 34:4-5 Zedekiah would not die by the sword, however, but in peace.<sup>466</sup> The people of Judah would lament Zedekiah's death by burning spices, a traditional way of expressing grief (cf. 22:18; 2 Chron. 16:14; 21:19). Yahweh promised this to the king. The Babylonians evidently permitted the Judeans in exile to mourn the death of their king in this way.
- 34:6-7 Jeremiah delivered this message to Zedekiah when Nebuchadnezzar was besieging the last two remaining fortified cities of Judah (beside Jerusalem), namely, Lachish and Azekah, both important Judean towns in the Shephelah.<sup>467</sup> Lachish stood about 25 miles southwest of Jerusalem and Azekah about 11 miles north of Lachish and about 18 miles west southwest of Jerusalem.<sup>468</sup> Lachish was larger than Jerusalem.<sup>469</sup> It fell to the Babylonians in 587 B.C.

### Treachery against servants 34:8-22

This incident happened during the respite in the siege, as did those recorded in 32:1-15; 37—38; and 39:15-18 (cf. vv. 21-22). The year was about 588 B.C.

<sup>464</sup>See M. Weinfeld, "The Loyalty Oath in the Ancient Near East," *Ugarit-Forschungen* 8 (1976):380.

<sup>465</sup>Scalise, p. 180.

<sup>466</sup>Since Zedekiah died in prison in Babylon, some commentators believe Jeremiah's prophecy of his peaceful death was conditioned on his surrendering to the Babylonians. Probably the promise was not conditional and contrasted a death in battle with a death not in battle, which would have been peaceful by comparison.

<sup>467</sup>The Shephelah was the foothills between the coastal plain to the west and the hill country to the east.

<sup>468</sup>An important archaeological find, the Lachish Letters, 21 in all, contain calls for help from outpost commanders to the garrison commander at Lachish. These letters confirm the accuracy of the biblical references to the siege of Lachish. See Pritchard, ed., p. 324.

<sup>469</sup>Harrison, *Jeremiah and . . .*, p. 146.

- 34:8-9 The following message came to Jeremiah from the Lord after Zedekiah had commanded all the Jerusalemites to free their fellow Israelite servants.<sup>470</sup>
- 34:10 The people of Jerusalem entered into a covenant to free their servants, and they followed through with their promise and liberated them. We do not know their motive(s). Perhaps the servants were needed to defend the city along with their masters, or they may have provided too many mouths for their masters to feed. Perhaps this represents repentance on the part of the masters who wanted to honor the Mosaic Covenant (cf. Exod. 21:2-6; Deut. 15:12-18). If it was repentance, it was short-lived and shallow.
- 34:11 Shortly thereafter the masters reneged on their promise, broke their covenant, and brought their servants back into subjection. It was a predictable response from people who had long ago and repeatedly demonstrated that they were covenant-breakers. Nebuchadnezzar's withdrawal may have been the impetus for the peoples' decision to break their promise to their servants. They may have thought that they were safe and that life would return to normal soon.
- 34:12-13 The Lord then sent Jeremiah to remind the people that He had made a covenant with their forefathers to set them at liberty from their bondage in Egypt (Exod. 19:4-6). They of all people should have shown mercy to others in bondage. The Passover commemorated their emancipation from Egyptian slavery.
- 34:14 Part of the Mosaic Covenant specified that the Israelites should liberate their servants who had sold themselves to them after six years of service (cf. Exod. 21:2-6; Deut. 15:12-18). But the forefathers had disobeyed the Lord and disregarded His word.
- 34:15-16 Recently the people had made a covenant to release their neighbors and had followed through with it, but then they changed their minds and brought them back into servitude. The fact that they had made this covenant in the temple indicates that they made it with the Lord as well as with one another. Breaking it profaned the Lord's name (reputation) because they had made the covenant in His name.<sup>471</sup>
- 34:17 Because the people had not released their servants, the Lord was going to release them from His protection to experience the sword, disease, and starvation. They would become an awful example to the other kingdoms of the earth. Then there would be no distinction between Hebrew masters and servants; they would all be servants of Nebuchadnezzar.

---

<sup>470</sup>Israelites sometimes entered into servanthood to pay off a debt they owed to the person who became their master. This seems to have been the most common cause of this condition in Israel.

<sup>471</sup>This temple event was not a full-fledged covenant renewal ceremony, only a pledge to emancipate their servants.

34:18-20 The Lord would give all the people who had broken the covenant, regardless of their social position, into the hand of their enemy. They would die without the privilege of a burial; birds and beasts would consume their carcasses (cf. 7:33; 16:4; 19:7; Deut. 28:26). They had used a typical covenant-making ritual. They had cut a young calf in two and the parties of the covenant then passed between the halves (cf. Gen. 15:10, 17).

"The fate of the animal was a picture of the fate that would befall them if they broke the covenant. The rite has its parallel in the covenant ceremonies of the ancient Near East in which a beast was cut in pieces to serve as a symbol of the judgment that would befall the covenant-breaker."<sup>472</sup>

This judgment would be the fate of the people (v. 20).

34:21 Yahweh would also give Zedekiah and his officials into the hand of the Babylonians, even though at the time of this message the Babylonian army had withdrawn from Jerusalem temporarily.

34:22 The sovereign Lord was going to command the Babylonian army to go back to Jerusalem, to fight against it, to take it, and to burn it. He would also make the cities of Judah a desolation without human inhabitants (cf. 10:22). This further breach of covenant was one more nail in the coffin of the Southern Kingdom.

"When Jeremiah redeems his cousin's land (chap. 32) and when the Rechabites refuse to drink wine (chap. 35), they act out of loyalty to ancient obligations in spite of the threatening circumstances of the Babylonian attack. When Judah's leading citizens take back their slaves, they not only violate covenants old and new; they deny the LORD's word through Jeremiah that their land had been assigned to Nebuchadnezzar's control, just as King Jehoiakim had denied it (chap. 36)."<sup>473</sup>

### **The lesson of the Rechabites ch. 35**

The theme of Judah's faithlessness carries over from chapter 34. The promise-breakers in 34:8-22 contrast with the promise-keepers in chapter 35. The events described in chapters 35 and 36 preceded those in chapters 32—34 chronologically.

This was another of Jeremiah's symbolic acts that the Lord commanded. The chapter consists of three parts: the main narrative (vv. 1-11), a prose oracle addressed to the people of Judah and Jerusalem (vv. 12-17), and a prose oracle addressed to the Rechabites (vv. 18-19).

<sup>472</sup>Thompson, p. 613. Cf. Gen. 15:12-21.

<sup>473</sup>Scalise, p. 190.

### The meeting with the Rechabites 35:1-11

- 35:1 This oracle came to Jeremiah during King Jehoiakim's reign (609-598 B.C.) after the Babylonians had begun to invade Judah (v. 11). Second Kings 24:1-2 reads, "In his [Jehoiakim's] days Nebuchadnezzar king of Babylon came up and Jehoiakim became his servant for three years; then he turned and rebelled against him [in 602 B.C]. And the LORD sent against him bands of Chaldeans, bands of Syrians, bands of Moabites, and bands of Ammonites. So He sent them against Judah to destroy it . . ." This seems to be the setting for what follows. The year was probably 602 or 601 B.C. (cf. 12:7-13).
- 35:2 Jeremiah was to visit the Rechabite family and to bring them to the temple. In one of the rooms that surrounded the temple proper, Jeremiah was to give them wine to drink.
- The Rechabites were a branch of the Kenite clan that descended from Jethro, Moses' father-in-law (cf. Judg. 1:16; 1 Chron. 2:55).<sup>474</sup> They had previously settled in northern Israel (Judg. 4:17; 5:24) and in southern Judah (1 Sam. 15:6). Evidently Jonadab's branch of the family had moved from the north into the Southern Kingdom following the Assyrian invasion of 722 B.C. (cf. v. 6).
- 35:3-4 The prophet did as the Lord had commanded him. He brought the whole extended family of the Rechabites into one of the large rooms on the second floor of the temple (cf. 1 Kings 6:5; 1 Chron. 28:12; 2 Chron. 31:11). The specific description of the location of the room in which this event took place contributes to the authenticity of the story.
- Jaazaniah was evidently the leader of the clan at this time. The reference to Hanan ben Igdaliah as "the man of God" probably identifies him as a prophet, though it could simply mean that he was a godly man. His "sons" may have been his disciples. He appears to have been an ally of Jeremiah's. Maaseiah was probably the father of Zephaniah the priest (cf. 21:1; 29:25; 37:3). His position of doorkeeper of the temple, of which there were three, was an important one; those who held it received special punishment when the Babylonians took Jerusalem (cf. 52:24-27; 2 Kings 25:18-21).
- 35:5 Jeremiah also set before the Rechabites pitchers of wine and cups to drink it, and he told them to drink the wine. He did not just ask them if they would like some wine to drink, but He made it very easy for them to drink it. His position as a true prophet of Yahweh would have encouraged them further to drink.

---

<sup>474</sup>Gerald L. Keown, *Jeremiah 26—52*, pp. 195-96, wrote an extended excursus on the identity of the Rechabites. Keown wrote the commentary on chapters 35-45 and 52 for this volume.



- 35:6 The Rechabites refused Jeremiah's offer explaining that one of their ancestors, Jonadab ben Rechab, had commanded his descendants never to drink wine. Abstinence was not a requirement of the Mosaic Law; it was simply a requirement that Jonadab imposed on his family.<sup>475</sup>
- Jonadab lived in the Northern Kingdom during the reign of King Jehu (841-814 B.C.). He helped Jehu purge Israel of Baal worship about 840 B.C. (cf. 2 Kings 10:15-23).
- 35:7 Jonadab had also commanded his family not to build a house or plant crops or grapevines or to own a vineyard. They were to live in tents as semi-nomads rejecting all aspects of settled living. We do not know why Jonadab had imposed these restrictions, but he may have felt that settled living in a Canaanite culture involved some temptations that a nomadic existence guarded against.<sup>476</sup>
- 35:8-10 The Rechabites explained that they had obeyed their ancestor's commands faithfully since the time he gave them. For over 200 years they had been faithful and obedient (cf. 2 Kings 10:15-23).
- 35:11 The only time they lived in a city was when Nebuchadnezzar's vassals invaded the Judean countryside. Then they moved into the city for protection out of necessity, not because they had abandoned their principles. Jerusalem was not under siege at this time, but the surrounding countryside was being invaded.

### **The rebuke of the Judahites 35:12-17**

- 35:12-13 After this experience, the Lord instructed Jeremiah to speak to the people of Jerusalem and Judah. He was to ask them if they would not receive instruction from Him.<sup>477</sup>
- 35:14 The Rechabites had faithfully obeyed their ancestor, but the people of Judah and Jerusalem had not obeyed the Lord's instructions even though He had spoken to them repeatedly. Jeremiah was not expressing approval for the nomadic life and ascetic convictions of the Rechabites, only their faithful obedience to their forefather.

"Nor is it [this story] per se a temperance lesson, despite its use for that purpose by some Sunday school quarterlies."<sup>478</sup>

---

<sup>475</sup>Faithful Nazirites also abstained from wine and grape products (cf. Num. 6; Judg. 13:4-7; 1 Sam. 1:11), though the Rechabites do not seem to have been Nazirites. The Nazirite vow was normally for a brief time, but the Rechabites had abstained from wine for generations.

<sup>476</sup>Thompson, pp. 617-18.

<sup>477</sup>Kidner, p. 118, speculated that Jeremiah may well have expected that when the Lord sent him a message it would have been one censuring the Rechabites for their eccentric lifestyle, legalism, and refusal to drink wine. But the Rechabites' chosen lifestyle was no problem to Yahweh.

<sup>478</sup>Feinberg, "Jeremiah," p. 600.

- 35:15 The Lord had also sent His servants the prophets to His people again and again urging them to repent, to change their deeds, and to stop worshipping idols. If they did, they could continue to dwell in the land the Lord had given their forefathers. But the people had refused to listen.
- 35:16 The Rechabites had obeyed Jonadab's instructions, but the Judahites had not listened to Yahweh (cf. 7:24-28; 11:1-17; 13:10; 25:4-8; 26:2-6; 29:17-29). The Lord used the Rechabites as a clinching argument in His "trial" against Judah.
- 35:17 Therefore, the Lord was going to bring on the people all the disaster that He had previously warned them about. They had not listened to Him when He spoke to them or answered Him when He called to them.

"Notice the telling contrasts between the Rechabites and Judah.

"1. The Rechabites obeyed a fallible leader (v. 14); Judah's leader was the eternal God (cf. Mal 1:6).

"2. Jonadab gave his commands to the Rechabites only once; God repeatedly sent his messages to his people (v. 15).

"3. The restrictions that bound the Rechabites did not deal with eternal issues; God's messages to his people had eternal as well as temporal implications.

"4. The Rechabites obeyed the commands of Jonadab for about three hundred years; the Lord's people constantly disobeyed (v. 16).

"5. The loyalty of the Rechabites would be rewarded; for their disloyalty God's people would be punished (v. 17)."<sup>479</sup>

### **The promise to the Rechabites 35:18-19**

- 35:18 Jeremiah then took a promise from the Lord back to the Rechabites. The Lord praised them for their tenacity in clinging to what they believed to be right.
- 35:19 Someone from their family would "stand before" Yahweh forever because they had obeyed their father, Jonadab. "Stand before" usually describes someone who served Yahweh in some special way (cf. 7:10; 15:19; Deut. 4:10; 10:8; 1 Kings 10:8; 17:1; 18:15; 2 Kings 3:14; 2 Chron. 29:11). However it also describes simple worshippers of Yahweh (7:10; Lev. 9:5; Deut. 4:10). The promise probably pointed to a continuing line rather than to a specific ministry.<sup>480</sup>

"According to the Mishnah 'the children of Jonadab son of Rechab' had a fixed day in the year for bringing wood for

---

<sup>479</sup>Ibid., p. 602.

<sup>480</sup>Dyer, "Jeremiah," p. 1180.

the altar of the temple. Other traditions refer to 'water-drinking' sacrificers whose descent is traced to Jonadab."<sup>481</sup>

"Even today, in Syria and Arabia, there are groups that claim to be Rechabites and that follow the Rechabite rule."<sup>482</sup>

"God is always looking for individuals whose lives are characterized by faithfulness. Such individuals will experience God's blessing even in the midst of trials."<sup>483</sup>

"Incidentally, as a secondary thrust of this episode, we are reminded that God, who loves unity and truth, is no lover of uniformity. By his own order of Nazirites he called some people, but not others, to an austerity not unlike that of the Rechabites, to make a particular point; and the fact that Jesus and John the Baptist glorified God by different lifestyles should open our minds to the reality and value of specialized callings—such as even the once-flourishing temperance movement which adopted the name of Rechabites in nineteenth-century England."<sup>484</sup>

### Jeremiah's scroll ch. 36

"While ch. 36 is, in a sense, an independent unit, it is at the same time the last segment in a 'tradition complex' which begins at ch. 26, where Jeremiah is vindicated as a true prophet of Yahweh by Jerusalem's highest court and where the aim of his prophetic ministry is set out, and ends with ch. 36 where the continuing negative response of the people and of the king reaches a climax and the rejection of the nation is confirmed. The history of the mediation of Yahweh's word by the faithful prophet Jeremiah concludes and another complex of chapters dealing with the prophet's sufferings follows in chs. 37—43."<sup>485</sup>

### Its writing 36:1-8

36:1           The Lord sent a message to Jeremiah in the fourth year of King Jehoiakim's reign, sometime between April of 605 and April of 604 B.C. (cf. 25:1)

"The preaching of Jeremiah offers Judah an opportunity to turn from their sinful ways and avoid destruction, but Jehoiakim's rejection of the prophetic word brings Judah

<sup>481</sup>Thompson, p. 619. The references in the Mishnah and Talmud are in his footnotes.

<sup>482</sup>Graybill, p. 681.

<sup>483</sup>Dyer, in *The Old . . .*, p. 625.

<sup>484</sup>Kidner, p. 119.

<sup>485</sup>Thompson, p. 621.

under a sentence of irrevocable judgment. The 'fourth year of Jehoiakim' (605 BC) is a critical moment in Judah's history where the fate of the nation is sealed and Babylon under Nebuchadnezzar emerges as the human instrument of divine judgment. Deliverance is reserved for only a tiny minority (the Rechabites and Baruch) who reflect faithfulness in their lives. National restoration will only come in the distant future when that faithfulness characterizes the nation as a whole (cf. 31:31-34)."<sup>486</sup>

36:2 Jeremiah was to write on a scroll (Heb. *megillath sepher*) all the prophecies that he had delivered concerning Israel, Judah, and the other nations since he began prophesying in the reign of Josiah (627 B.C.; cf. 1:2; 25:3).<sup>487</sup> Perhaps the Babylonians' victory over the Assyrians and Egyptians at Carchemish in 605 B.C. provided the impetus for this project. With the Babylonians in power, Judah was one giant step closer to invasion.

36:3 All these recorded prophecies of coming judgment might move the Judahites to repent (cf. 25:13). If the people repented, the Lord would forgive them.

36:4 Jeremiah then called for Baruch ben Neriah who copied down these prophecies from the Lord as Jeremiah dictated them to him (cf. 32:12-13).

"Writing was a specialized skill, often restricted to a professional class. Learned men could read, but (like executives today) scorned to write."<sup>488</sup>

36:5-6 When the papyrus or parchment scroll was complete, Jeremiah instructed Baruch to take it and to read the prophecies to the people of Jerusalem and Judah in the temple courtyard. Baruch was to do this on a fast day so many people would hear him. At this time in Israel's history the nation's leaders sometimes called fast days in times of national emergency (cf. 2 Chron. 20:3; Joel 1:14; 2:12, 15). Evidently Jeremiah anticipated a crisis since Babylon became the major power in the ancient Near East, the "enemy from the north," with its victory at Carchemish. Jeremiah could not go to the temple himself for reasons the text does not explain.

---

<sup>486</sup>Gary E. Yates, "Narrative Parallelism and the 'Jehoiakim Frame': A Reading Strategy for Jeremiah 26—45," *Journal of the Evangelical Theological Society* 48:2 (June 2005):281.

<sup>487</sup>Most of the prophecies in the present Book of Jeremiah that date from this period are in chapters 1—25 and 46—51, but they were probably not in the same order on this scroll. Since Baruch and Jehudi read them on three separate occasions in one day (vv. 8, 15, 21), perhaps Baruch did not read the whole scroll on the first two of these occasions.

<sup>488</sup>Graybill, p. 681.

36:7 Jeremiah hoped that the reading of the scroll would move the people to repent and to pray since the Lord was very angry with His people.

36:8 Baruch then went to the temple and did as Jeremiah had instructed him.

**Its reading 36:9-20**

36:9 During the winter of 604-603 B.C., the people, not the king, declared a fast. The occasion for the fast may have been the arrival of Babylonian armies on the Philistine plain or the Babylonians' defeat of Ashkelon then.<sup>489</sup>

36:10 On this occasion Baruch read Jeremiah's scroll to all the people. He stood in the room of Gemariah ben Shaphan the scribe (state secretary) in the upper or outer temple courtyard near the New Gate of the temple (cf. 20:2; 26:10; 2 Kings 15:35).<sup>490</sup> This position would have made it easy for the people there to hear him. It also suggests that Gemariah was sympathetic to Jeremiah (cf. 26:24). When the priests discovered the scroll of the law in the temple during Josiah's reign, it was Shaphan, Gemariah's father, who read it to the people (cf. 2 Kings 22:3—23:3).<sup>491</sup>

36:11-13 When Micaiah, Gemariah's son, heard the scroll read, he went into the scribe's room in the palace where all the king's officials had gathered and told them what he had heard. Achbor, the father of Elnathan, had been present at the reading of the law scroll in Josiah's day (2 Kings 22:12).

36:14 The officials then sent Jehudi to Baruch in the temple precincts and told him to bring Baruch and the scroll to them. Jehudi must have been an important person since the writer mentioned three generations of his ancestors, though there are no other references to him in the Bible.

36:15-16 When Baruch arrived, the officials asked him to sit down and read the scroll to them, which he did. What he read surprised them, and they told him that they would report what he had read to the king.

36:17-18 They asked Baruch how he wrote the scroll, and Baruch replied that he had written it as Jeremiah dictated the prophecies to him. They evidently wanted to make sure that Jeremiah was the source of the prophecies and not Baruch.

36:19 The officials then told Baruch to go into hiding with Jeremiah and to tell no one where they were. They expected the king to react negatively and

---

<sup>489</sup>Harrison, *Jeremiah and . . .*, p. 151. See also D. J. Wiseman, *Chronicles of Chaldean Kings (626-556 B.C.) in the British Museum*, p. 69.

<sup>490</sup>See the diagram of Solomon's Temple near my comments on 20:2.

<sup>491</sup>See the diagram with information about Shaphan's sons near my comments on 26:24.

violently when he heard the news. Earlier Jehoiakim had extradited and murdered the prophet Uriah who had also prophesied against Judah and Jerusalem (26:20-24).

- 36:20 The officials first deposited Jeremiah's scroll in the room where they were for safe keeping and then went and told Jehoiakim what the scroll contained.

### **Its burning 36:21-26**

- 36:21 The king proceeded to send Jehudi to get the scroll from Elishama in the scribe's room. When Jehudi returned with it, he read it to the king and his officials.
- 36:22 Since it was winter, the king was sitting in his winter quarters with a fire burning in the brazier before him (cf. Amos 3:15). The king's winter quarters were evidently warm rooms in the palace.
- 36:23 After Jehudi had read a few columns of text, Jehoiakim reached over and cut off what he had read and tossed it into the fire.<sup>492</sup> He did this with the whole scroll; he burned it all up. This was a symbolic act; Jehoiakim was claiming that Jeremiah's prophecies would come to an end just as surely as his scroll came to an end.<sup>493</sup> Jehoiakim's slow, methodical destruction of the scroll made his rejection of its message a much more emphatic gesture than if he had burned the whole thing at once in a fit of rage.<sup>494</sup>

This king's response to hearing the Lord's word stands in stark contrast to that of his father Josiah who tore his clothes in remorse when he heard the law scroll read to him (2 Kings 22:11-20). Josiah had feared and called the people to repentance, but Jehoiakim feared nothing and called for the prophet's arrest.

- 36:24-25 Jeremiah's prophecies did not frighten the king or his servants at all nor did they express any grief over what Jeremiah had predicted. The entreaties of three of his officials did not discourage Jehoiakim from burning up the whole scroll. One of these men, Elnathan ben Achbor, had previously extradited the prophet Uriah from Egypt (cf. 26:20-23). The people had failed to listen to the Lord, and now the king and his servants

---

<sup>492</sup>Scrolls consisted of several sheet of papyrus or parchment that had been glued together and wrapped around a small rod. As the reader rolled the scroll off the rod and read it from right to left, the printing appeared in parallel, perpendicular columns that resembled doors. The Hebrew word for "column," *delathoth*, literally means "door." Binding documents in book (codex) form was unknown in Old Testament times.

<sup>493</sup>M. Kessler, "The Significance of Jer 36," *Zeitschrift für die Alttestamentliche Wissenschaft* 81 (1969):382.

<sup>494</sup>Kidner, p. 121.

did the same thing. Surely the possibility of national repentance seemed remote.

"This is an exact picture of our own generation. Men today do not perhaps burn the Bible, nor does the Roman Catholic Church any longer put it on the index, as it once did. But men destroy it in the form of exegesis; they destroy it in the way they deal with it. They destroy it by not reading it as written in normal literary form, by ignoring historical-grammatical exegesis, by changing the Bible's own perspective of itself as propositional revelation in space and time, in history."<sup>495</sup>

36:26 Then Jehoiakim ordered the arrest of Baruch and Jeremiah, but those sent to find them could not because the Lord had hidden them.<sup>496</sup> Having destroyed the scroll, the king turned next to destroy its authors. Jehoiakim did not continue to hunt down Jeremiah, however, because later the prophet was able to move about the city (ch. 35).

"The narrative in these verses seems to have been composed as a conscious parallel to 2 K. 22. In each case a scroll is brought before the king. First the scroll comes into the hands of a state official (2 K. 22:9-10; Jer. 36:10-11). Both narratives record the reaction of the king (2 K. 22:11-13; Jer. 36:23-26). Both narratives refer to an oracle that follows the king's response (2 K. 22:15-20; Jer. 36:28-31). In 2 K. 22:11 Josiah 'rent his clothes'; in Jer. 36:24 Jehoiakim did not rend his clothes but rent the scroll."<sup>497</sup>

"Josiah burns altars in an attempt at reform; Jehoiakim attempts to invalidate the message by burning the scroll. Josiah 'heard' the word of the LORD, while Jehoiakim pointedly does not 'hear.' Finally, the end result is that God 'hears' Josiah, but the outcome for Jehoiakim and Judah is another matter as Jer 36:30-31 clearly indicate . . ."<sup>498</sup>

### **Its rewriting 36:27-32**

36:27-28 The Lord commanded Jeremiah to make another copy of the scroll that the king had burned (cf. 2 Kings 22:15-20).

---

<sup>495</sup>Schaeffer, p. 61.

<sup>496</sup>According to Jewish tradition, the accuracy of which is uncertain, Jeremiah's place of concealment was the so-called "Grotto of Jeremiah" outside the Damascus Gate of Jerusalem.

<sup>497</sup>Thompson, p. 628.

<sup>498</sup>Keown, p. 203. For further development of these contrasts, see C. D. Isbell, "2 Kings 22:3—23:24 and Jeremiah 36: A Stylistic Comparison," *Journal for the Study of the Old Testament* 8 (1978):33-45; and M. Kessler, "Form Critical Suggestions on Jer 36," *Catholic Biblical Quarterly* 28 (1966):389-401.

- 36:29 He was also to send a message from the Lord to the king. Jehoiakim had burned the first scroll because it contained prophecies that Nebuchadnezzar would come and destroy the land and its inhabitants.
- 36:30 Because Jehoiakim had done this, he would have no descendant to follow him on Judah's throne. His son Jehoiachin did reign for three months after his father, but Jehoiachin assumed the throne without authorization and Nebuchadnezzar quickly deported him to Babylon. Furthermore Jehoiakim would suffer an ignominious death without burial (cf. 22: 18-19). He who threw (Heb. *hishlik*) the scroll into the fire would be thrown (Heb. *hushlak*) out into the elements. Josiah, in contrast, received an honorable burial (2 Kings 23:30; 2 Chron. 35:24). Jehoiakim evidently died either in a palace uprising or in a revolt by the people (cf. 22:18-19).<sup>499</sup>
- 36:31 The Lord would also punish him and his descendants and his servants with all the judgments that Jeremiah had predicted for the people of Jerusalem and Judah. He would send them because they had refused to listen to the Lord.
- 36:32 Jeremiah then dictated the prophecies to Baruch again, and he wrote them down on a second scroll. This time Jeremiah included other prophecies, those that he had received since he had dictated the first scroll. This document probably became the "first draft" of the present Book of Jeremiah.<sup>500</sup> The prophet uttered many more oracles between 604 and 586 B.C.

"As Hananiah later attempts to render the symbolic word of judgment futile by destroying the wooden yoke, so Jehoiakim attempts to destroy the word literally, in the fire. In Jer 28, a yoke of iron is Yahweh's last word. The end of this scene introduces a new scroll, with specific 'words' added for Jehoiakim in light of his rejection of the scroll. Jehoiakim cannot thwart the word of the LORD, and to attempt to do so brings inevitable consequences."<sup>501</sup>

## **2. Incidents during the fall of Jerusalem chs. 37—39**

The events recorded in these chapters all took place during the siege of Jerusalem (ca. 588-586 B.C.), when Zedekiah was king. They are in chronological order. Jeremiah was probably in his mid-fifties at this time.

### **Zedekiah's prayer request and its answer 37:1-10**

This event happened about 18 years after the one recorded in chapter 36.

<sup>499</sup>Feinberg, "Jeremiah," p. 609; Graybill, p. 682.

<sup>500</sup>This chapter is of special interest because it records the production of one of the books of the Bible.

<sup>501</sup>Keown, p. 207.



**The historical situation 37:1-5**

- 37:1 Nebuchadnezzar, sovereign over Judah since Jehoiakim's unsuccessful rebellion against him in 598 B.C., set up Zedekiah, Jehoiakim's brother, as Judah's king in 597 B.C. (cf. 2 Kings 24:17). Jehoiakim's son, Jehoiachin (Coniah), had reigned for three months following his father's deposition, but then Nebuchadnezzar deported him to Babylon (2 Kings 24:12). Jehoiachin was never the authorized king of Judah. Thus Jeremiah's prophecy about Jehoiakim's end had come to pass (cf. 36:30).
- 37:2 Neither Zedekiah nor his nobles nor the people of the land paid any attention to Jeremiah's prophecies to them.
- 37:3 However, Zedekiah sent two messengers to Jeremiah requesting the prophet's prayers on the nation's behalf. This was the second time that the king asked Jeremiah for information about the outcome of the invasion (cf. ch. 21). It is always easier to pray than to repent (cf. Isa. 1:10-20). Perhaps Zedekiah was hoping for a last-minute deliverance such as God granted Jerusalem in Hezekiah's days (2 Kings 19:32-37). But Jeremiah had already predicted the fates of this king and the city at the commencement of the siege (34:1-7).
- Zephaniah the priest was a member of the delegation that Zedekiah had sent to Jeremiah at the beginning of the siege (21:1-10). He was also the recipient of a letter from the false prophet Shemaiah, who was already in Babylonian exile, demanding Jeremiah's imprisonment (29:24-32). Jehucal appears later as Jeremiah's enemy (38:1).
- 37:4 Jeremiah was at this time still free to move about the city. Later his arrest and confinement prohibited this.
- 37:5 About this time Pharaoh Hophra's Egyptian army moved eastward toward Judah to support Zedekiah in his revolt against Babylon (2 Kings 24:7; Ezek. 17:11-21). This caused the Babylonians to lift the siege of Jerusalem and prepare to battle the Egyptians (cf. 34:8-11).

**The Lord's message to Zedekiah 37:6-10**

- 37:6-7 The Lord told Jeremiah to tell Zedekiah that the Egyptian army, which had come to help him, would return home. It did, in fact, retreat before joining battle.
- 37:8 The Babylonians would return, besiege, capture, and burn Jerusalem.
- 37:9-10 Zedekiah should not deceive himself by thinking that the Chaldeans had departed from Jerusalem permanently. Jerusalem's destruction was so

certain that even if the Judeans defeated the entire Babylonian army the Lord would use the wounded Chaldean soldiers to rise up and destroy the city. In other words, deliverance was out of the question.

### **Jeremiah's arrest and imprisonment 37:11-21**

The text records five steps in Jeremiah's prison experiences. First, he was arrested in the gate and committed to a dungeon on a false charge of treason (37:11-15). Second, he was released from the dungeon but restricted to the courtyard of the prison (37:16-21). Third, he was imprisoned in Malchijah's miry dungeon in the prison courtyard (38:6). Fourth, he was released from this dungeon but restricted to the prison courtyard again until Jerusalem fell (38:17-28). Fifth, Nebuzaradan, the captain of the Babylonian guard, took him in chains to Ramah, where he was released (40:1-4).<sup>502</sup>

### **The reason for his arrest and imprisonment 37:11-16**

37:11-12 During the lifting of the siege of Jerusalem just described (v. 5), Jeremiah left the city to conduct some personal business concerning the purchase of some property in the territory of Benjamin. This may have been the land in Anathoth that his cousin Hanamel later wanted him to buy (cf. 32:6-15).

Since Jeremiah was imprisoned in the court of the guard when Hanamel approached him about buying this property, Jeremiah may have left the city to view the land anticipating that his cousin would make the offer. The present incident closes with Jeremiah confined in the court of the guard (v. 21). This suggests that the present incident occurred before Hanamel's offer, which he made when Jeremiah was confined there. Or these may be two unrelated incidents.

37:13 Jeremiah was leaving Jerusalem by the northern gate that led to the territory of Benjamin when Irijah, a captain of the guard, arrested him.<sup>503</sup> He charged the prophet with defecting to the enemy. Jeremiah had urged others to submit to the Babylonians (21:9; 38:2), and some of the people had taken his advice (38:2, 19; 39:9; 52:15), so the charge was plausible.

37:14 Jeremiah denied the charge but to no avail. Irijah took him prisoner and brought him before the city officials.

37:15-16 The officials angrily beat Jeremiah and confined him in the house of a scribe named Jonathan, which they had converted into a jail.<sup>504</sup> Jeremiah remained in an underground dungeon for many days. The Hebrew words describing this cell are difficult to interpret. They may describe "a complex of large, underground cisterns that had been converted into a

<sup>502</sup>*The New Scofield . . .*, p. 812.

<sup>503</sup>Irijah's ancestor, Hananiah, would not have been the same man who opposed Jeremiah (28:10).

<sup>504</sup>This reference begins what some scholars have referred to as "Jeremiah's passion."

prison."<sup>505</sup> Jeremiah feared for his life there (v. 20). The attitude of Zedekiah's officials contrasts sharply with that of Jehoiakim's officials in the previous chapter (36:11-19).

### **The consequences of his arrest and imprisonment 37:17-21**

- 37:17 Zedekiah secretly sent for Jeremiah and brought him into the palace. The king feared his nobles who were "hawks" militarily and hostile to Jeremiah. Zedekiah asked the prophet if the Lord had given him any message in response to his previous praying (v. 3). Jeremiah replied that he did have a message from the Lord and it was that the king would become a prisoner of Nebuchadnezzar. The king was really the one bound in this situation, and the prisoner was the truly free man.<sup>506</sup>
- 37:18-19 Jeremiah then asked Zedekiah what he had done to deserve imprisonment. His prophecies had proved true whereas the messages of the prophets who predicted that Nebuchadnezzar would not invade the land had proved false. These false prophets were evidently free, but Jeremiah was in prison.
- 37:20 Jeremiah begged the king not to send him back to prison because he would die there.
- 37:21 Zedekiah conceded and sent him to a better place of confinement, the court of the guard (cf. 32:2; Neh. 3:25).<sup>507</sup> He also ordered that the prophet receive bread regularly as long as there was bread in the city (cf. Rom. 8:28).<sup>508</sup> Had Zedekiah not feared his nobles this vacillating king might have given Jeremiah his freedom.

"In many ways, Zedekiah is a tragic figure. It seems that he is attracted to Jeremiah and his message like iron filings to a magnet, yet he is never able to summon enough resolve to act in response to that message. While such conclusions are speculative, it is possible that Zedekiah presents a paradigm of persons whose rejection of the purposes of God through their weakness of character is every bit as damaging and damning as the aggressive rebellion of Jehoiakim."<sup>509</sup>

### **Zedekiah's last dealings with Jeremiah ch. 38**

Some scholars regard chapter 38 as a retelling of the event just narrated in chapter 37. There is some precedent for such a practice in this book. There are two accounts of

<sup>505</sup>Dyer, "Jeremiah," p. 1182. Feinberg, "Jeremiah," p. 613, interpreted the place as "a vaulted cell in a dungeon."

<sup>506</sup>This interview anticipates other similar ones between Jesus and Pilate and Herod, and between Paul and Felix, Festus, and Agrippa.

<sup>507</sup>It was here that his cousin Hanamel visited Jeremiah (34:1-15).

<sup>508</sup>This is the only place in Scripture where the name of a street in Jerusalem appears: Baker Street.

<sup>509</sup>Keown, p. 218.

Jeremiah's Temple Sermon (chs. 7 and 26) and perhaps two accounts of Jeremiah's release by the Babylonians (38:28b; 39:3, 14 and 39:11-12; 40:1-6). However it is also plausible that Jeremiah had to endure two similar imprisonments, or even more than two. I believe this chapter records a different, albeit similar, and subsequent incident because of the differences in the two accounts.

### **The plot to arrest Jeremiah 38:1-6**

38:1-3 Four prominent men in Jerusalem heard Jeremiah preaching that anyone who remained in Jerusalem would die but those who surrendered to the Chaldeans would live. He prophesied, apparently at this time from the court of the guardhouse (37:21), that Jerusalem would certainly fall to the Babylonians.

Gedaliah may have been the son of the Pashhur who beat Jeremiah and placed him in the stocks (20:1-6). Jucal was probably the Jehucal who visited Jeremiah during the temporary withdrawal of the Babylonians (37:3). Pashhur ben Malchijah also visited Jeremiah at the beginning of the siege of Jerusalem in 588 B.C. (21:1).

38:4 These nobles complained to Zedekiah that Jeremiah was weakening the morale of the soldiers and discouraging the people from resisting the enemy. They accused the prophet of desiring to harm the people rather than seeking their wellbeing. This was a seditious thing to do, and Jeremiah could have been put to death if his accusers proved him guilty of treason.

"It was ironical . . . that the leaders who had played the traitor against Babylon, their overlord, were such sticklers for internal loyalty, and that they should profess concern for the peace and welfare (shalom, v. 4b) of the citizens whom they insisted on sacrificing."<sup>510</sup>

38:5 Zedekiah turned Jeremiah over to the nobles. He claimed he could not overrule their will. Obviously he should have stood up for Jeremiah, but he feared his state officials (cf. vv. 25-27). He was an early-day Pontius Pilate who washed his hands of his responsibility (cf. Matt. 27:24).

38:6 The nobles had Jeremiah placed in a cistern of one of the royal princes, Malchijah, which was in the court of the guardhouse. Jeremiah had previously been confined in this court or stockade (37:21), but now he was lowered into the cistern with ropes. The cistern had no water in it, but the bottom was very muddy, and Jeremiah sank into the mud. The nobles wanted him to die there of "natural causes" probably to alleviate their guilt (cf. Gen. 37:18-19).

---

<sup>510</sup>Kidner, p. 124.

"A typical cistern was dug out of limestone rock and consisted of a narrow neck perhaps three feet across and three or four feet in depth opening into a much longer bulbous cavity of varying depth. Water from catchment areas was directed to the opening."<sup>511</sup>

### Jeremiah's rescue from the cistern 38:7-13

38:7-8 A courtier in the palace, Ebed-melech (lit. "servant of the king"), heard about Jeremiah's plight. He happened to be an Ethiopian or Cushite (from modern-day southern Egypt, northeastern Sudan, and northern Ethiopia).<sup>512</sup> Often courtiers were eunuchs, but the Hebrew word translated "eunuch" here, *saris*, often means simply a male court official (cf. 29:2; Gen. 39:1; Dan. 1:7; et al.). Ebed-melech sought out the king, who was then at the Benjamin Gate, to speak to him. Kings went to city gates to hear complaints from their citizens (cf. 2 Sam. 15:2-4), so Ebed-melech went there with his complaint.

". . . only a despised foreigner cared enough for the prophet to risk trouble in saving him (cf. 39:15-18)."<sup>513</sup>

38:9 Ebed-melech informed the king that Jeremiah's enemies had acted wickedly by putting him in the cistern. The prophet would die if he remained there because there was no more food in Jerusalem and he would be neglected. Zedekiah had previously promised to provide food for Jeremiah as long as there was food available (37:21), so Ebed-melech may have been appealing to this promise.

"God, as is His way so often, used an insignificant person to touch off Jeremiah's rescue."<sup>514</sup>

38:10 Zedekiah authorized Ebed-melech to use 30 of the eunuch's own men to extract Jeremiah from the cistern.<sup>515</sup> Evidently Zedekiah expected that Ebed-melech might encounter some opposition and would need a lot of manpower.

38:11 Ebed-melech assembled his men and gathered together old clothes and rags from the palace wardrobe storeroom and let them down by ropes to Jeremiah.

---

<sup>511</sup>Thompson, p. 638.

<sup>512</sup>See J. Daniel Hays, "The Cushites: A Black Nation in the Bible," *Bibliotheca Sacra* 153:612 (October-December 1996):404-6.

<sup>513</sup>Graybill, p. 683. Compare the foreigner who carried Jesus' cross, Simon of Cyrene, also from North Africa.

<sup>514</sup>Jensen, p. 100.

<sup>515</sup>The Septuagint and one ancient Hebrew manuscript have "three" instead of "30," but 30 is probably correct.

38:12-13 The Ethiopian then told Jeremiah to use the clothes to cushion the ropes that he was to put under his armpits. Jeremiah did this, and the men were able to pull the prophet out of the cistern. However, he remained confined in the court of the guardhouse.

#### **Zedekiah's last interview with Jeremiah 38:14-28**

38:14 Shortly after this event Zedekiah had Jeremiah brought to him at one of the temple entrances, possibly the king's private entrance (cf. 2 Kings 16:18). He told the prophet that he was going to ask him a question and he wanted a straight answer.

38:15 Jeremiah replied that if he did give the king a straight answer Zedekiah would execute him and disregard what he said.

38:16 The king swore to Jeremiah by the living Lord who gave life that he would neither kill him nor turn him over to his enemies who would kill him. The implication of this oath was that since Yahweh gives life, He could take Zedekiah's life if he proved unfaithful to his word.

38:17 We do not know what Zedekiah's question was, but it must have been, Has the Lord changed His mind? No, He had not, but Zedekiah needed to change his. Jeremiah promised the king on the authority of almighty Yahweh, Israel's God, that if he surrendered to the Babylonian military officers he would live. Furthermore they would not burn down the city, and his whole household would survive. This must have seemed like a very unlikely possibility to Zedekiah since he had proved to be a rebellious vassal of Nebuchadnezzar. Suzerains usually mutilated and killed rebel kings who surrendered to them.<sup>516</sup> Ironically, Chaldean officials would have spared Zedekiah's life, but Judean officials were seeking to snuff out Jeremiah's life.

38:18 If Zedekiah did not surrender, the Chaldeans would capture the city and burn it, and the king would not escape.

38:19 Zedekiah admitted that he feared the Jews who had already surrendered. He feared that if he surrendered the Babylonians would turn him over to those Jews and they would torture him.

38:20 Jeremiah assured him that what he feared would not happen if he surrendered. He also urged the king to obey the Lord and surrender so things would go well with him.

38:21-22 If Zedekiah kept refusing to give himself up, the Lord promised that all the women in the palace would end up as the property of the enemy officers.

---

<sup>516</sup>Harrison, *Jeremiah and . . .*, p. 156.

It was customary for a conquering king to take over the harem of his defeated foe (cf. 2 Sam. 16:21-22). These women would curse Zedekiah for allowing his friends to mislead him. They would use the words that Jeremiah here composed or perhaps quoted from a traditional song about being betrayed and deserted by friends (cf. 20:10; Ps. 41:9; 69:14; Obad. 7). While the king delayed, his officers would get away. What had happened to Jeremiah physically (v. 6) would happen to Zedekiah politically, militarily, and spiritually: both were stuck in the mud.

- 38:23 Moreover all the family members of Zedekiah would fall into the hands of Nebuchadnezzar along with himself, and the Babylonian king would burn the city.
- 38:24 Zedekiah made Jeremiah promise that he would not tell anyone that they had had this conversation. If he kept it a secret, the prophet could live.
- 38:25-26 If Zedekiah's nobles asked Jeremiah what he and the king had talked about, he was to say that he had asked the king not to send him back to the house of Jonathan because he would die there. He had asked the king not to return him there earlier (37:20).
- 38:27 Sure enough, the state officials asked Jeremiah about his conversation with the king, but Jeremiah responded as Zedekiah had instructed him. He only told the nobles what was necessary and no more.
- 38:28 Zedekiah kept his word to Jeremiah who was able to stay in the court of the guardhouse until the city fell to the Babylonians.

### **The fall of Jerusalem 39:1-10**

What Jeremiah had predicted for so long finally became a reality for Judah. There are four chapters in the Bible that record the fall of Jerusalem reflecting the importance of this event (39; 52; 2 Kings 25; 2 Chron. 36).

- 39:1-2 Nebuchadnezzar and the Babylonian army captured Jerusalem and began its siege in 588 B.C. It took the Babylonians about eighteen months to breach the walls of the city, which they did in 586 B.C. (cf. 52:4-6).<sup>517</sup>
- 39:3 All the officials of the Babylonian army entered the city and eventually took their places at a gate in the middle of the city, in fulfillment of Jeremiah's prophecy in 21:4. This Middle Gate was evidently an opening in a wall that separated two parts of Jerusalem. This is the only reference to this gate in the Bible.

---

<sup>517</sup>For discussion of the dates, see Feinberg, "Jeremiah," p. 621. Dyer, "Jeremiah," p. 1185, argued for the siege lasting just over 30 months. This was the total length of the siege including the period of respite previously mentioned.

The writer mentioned two, three, or four of the Babylonian officials by name: Nergal-sar-ezer, Samgar-nebu, Sar-sekim the Rab-saris or chief official, and perhaps another Nergal-sar-ezer the Rab-mag or chief magi. Nergal-sar-ezer was probably Nebuchadnezzar's son-in-law who ascended the throne of Babylon in 560 B.C. The writer may have described him with two different titles in this verse, or there may have been two men with the same name. Samgar may be the title of Nergal-sar-ezer, and Nebu may describe a geographical district that he ruled.<sup>518</sup>

"In its context v. 3 is a parenthesis describing one of the things that was done soon after the fall of Jerusalem. Its true context is at v. 13, where it is inserted again in the first account of Jeremiah's release."<sup>519</sup>

- 39:4 When Zedekiah saw the invaders within the city, he and many of the Judean soldiers tried to escape by night exiting Jerusalem by a gate in the king's garden. This was probably the Fountain Gate near the Pool of Siloam (cf. Neh. 2:14; 3:15; 12:37). They took a passageway between the two walls of the city there (cf. Isa. 22:11) and headed east toward the Arabah (Jordan Valley). Zedekiah evidently wanted to escape to Ammon, an ally of Judah's at this time (cf. Ezek. 21:18-23).
- 39:5 The Chaldean soldiers spotted Zedekiah fleeing and finally caught up with him in the plains near Jericho. They captured him and took him to Nebuchadnezzar, who was at Riblah, an ancient city located on a highway between Egypt and Mesopotamia on the Orontes River in central Aramea (cf. 2 Kings 23:33). Riblah stood about 50 miles south of Hamath and 65 miles north of Damascus. There Nebuchadnezzar passed sentence on his rebellious vassal. Nebuchadnezzar evidently did not personally participate in the siege of Jerusalem; his headquarters during this campaign was at Riblah.
- 39:6-7 Nebuchadnezzar then slew Zedekiah's sons as their father watched as well as the Judean nobles. He also blinded Zedekiah and sent him bound in strong chains to Babylon where he died (cf. 52:11; Judg. 16:21). The last sight Zedekiah saw was the execution of his own children. Truly this last king of David's line was a pathetic figure.
- 39:8 Back in Jerusalem, the Chaldeans burned the royal palace, the other houses in the city, including the temple (52:13), and broke down the city walls to make it uninhabitable and indefensible. Thus began "the times of the Gentiles" (Luke 21:24), the period in history during which Israel is under Gentile control, which will continue until Christ's second coming.

<sup>518</sup>Keown, p. 229; Harrison, *Jeremiah and . . .*, p. 157.

<sup>519</sup>Thompson, p. 645.



39:9-10 Nebuzaradan (lit. the chief butcher, an archaic title), the captain of Nebuchadnezzar's bodyguard, was in charge of deporting the Jerusalemites to Babylon. He deported almost everyone who was left in the city plus the Judahites who had defected to the Babylonians. The only native inhabitants that he left behind were some of the poorest of the people to whom he gave vineyards and fields. It was in Babylon's best interests to maintain the agricultural productivity of Canaan.

### **The first account of Jeremiah's release 39:11-14**

The more specific accounts of two men's deliverance follow in the rest of this chapter. In contrast to Zedekiah's horrible fate, Jeremiah enjoyed the attentive care of the Babylonians. This contrast reflects on their previous responses to the word of the Lord.

39:11-12 Nebuchadnezzar ordered Nebuzaradan to take good care of Jeremiah and to do for him whatever he requested.

39:13-14 Nebuzaradan passed the king's orders along to the other Babylonian officials in Jerusalem. They released Jeremiah from his confinement in the court of the guardhouse (cf. 38:28) and entrusted him to Gedaliah, another favored Judean, who took him into his home. Jeremiah stayed among the poor people who remained in Jerusalem for some time.

### **The Lord's blessing of Ebed-melech 39:15-18**

The preceding pericope recorded how the Lord preserved his prophet, and this one shows how He preserved the prophet's rescuer.

39:15-16 Before his release from the stockade, the Lord told Jeremiah to give a message to Ebed-melech (cf. 38:7-13). Yahweh said he was about to fulfill His predictions about the destruction of Jerusalem, and the Ethiopian would witness these events.

39:17 The Lord promised to deliver Ebed-melech from the Babylonian soldiers. They would not kill him. He had, after all, delivered Jeremiah from death at the hand of Zedekiah's officials. This would be his reward for trusting in the Lord. The evidence of his trust was his respect and concern for Jeremiah, who proclaimed the Lord's words.

"Jer 39 presents a strong contrast between faithfulness and the lack of faith. Jeremiah and Ebed-melech represent those who are faithful to the LORD and to whom the LORD is faithful in return. Zedekiah represents faithlessness. In some respects, Zedekiah's faithlessness is of the most troublesome sort among people of faith. His faithlessness is not rejection of the LORD but an inability to act in courage when pressures mount. Like the church at Laodicea in Rev 3:15 [which was also blind], Zedekiah was neither hot nor cold, and he paid a terrible price for his indecision."<sup>520</sup>

---

<sup>520</sup>Keown, p. 231.

### **3. Incidents after the fall of Jerusalem chs. 40—45**

One of the important theological lessons of this segment of the book, especially chapters 40—44, is that disobedience leads to judgment.

"One would think that the fall of Jerusalem would have taught Judah a lesson she would never forget. However, by recording the events that happened after the fall of the city, Jeremiah demonstrated that the basic character of the people who remained in the land was unchanged. They still refused to trust in God or to submit to Babylon (cf. Ezek. 33:23-29)."<sup>521</sup>

#### **Events in Judah 40:1—43:7**

##### **The second account of Jeremiah's release 40:1-6**

This account describes other things associated with Jeremiah's being set at liberty. It contains more detail than 39:11-14.

- 40:1 Evidently after Jeremiah's release in Jerusalem Babylonian soldiers rounded him up when they saw him in the city streets supposing him to be a regular Judean. They took Jeremiah to Ramah, about five miles north of Jerusalem, along with the other chained Judean prisoners headed for exile. Ramah appears to have been a collection point for deportees before the long trip to Babylon.
- 40:2-3 In Ramah, Nebuzaradan learned that Jeremiah was among the captives about to be sent to Babylonia, so he released him again. The captain of the guard confirmed to Jeremiah that Yahweh had done to Jerusalem just as He had said He would because of the sins of His people. This pagan could see what Yahweh was doing even though Judah's leaders were spiritually blind.
- "As God's people, we have to bow in shame when the world publicly announces the sins of the saints (Gen. 12:10-20; 20:1ff; 2 Sam. 12:14)."<sup>522</sup>
- 40:4 Then Nebuzaradan freed the prophet from his shackles and gave him the choice of going to Babylon as a free man or staying in Canaan. If he went to Babylon, the captain promised to take care of him there. If he chose to stay in Canaan, he could live and move about wherever he wished.
- 40:5 As Jeremiah lingered, Nebuzaradan urged him to go back and remain with Gedaliah (cf. 39:14), whom Nebuchadnezzar had appointed governor over the cities of Judah, and the other remaining Judahites. Gedaliah was a part

---

<sup>521</sup>Dyer, "Jeremiah," p. 1186.

<sup>522</sup>Wiersbe, p. 131.

of the noble family of Shaphan.<sup>523</sup> Yet the choice was entirely up to the prophet; he had complete freedom to go wherever he wanted. Nebuzaradan also gave Jeremiah some provisions and a gift before he let him go.

"The courteous and humane treatment from the nation's enemy contrasts markedly with what Jeremiah had received from his own countrymen [cf. Matt. 13:57]."<sup>524</sup>

40:6 Jeremiah left Ramah and proceeded to Mizpah, two miles to the northwest of Jerusalem, where he stayed with Gedaliah and some of the Judahites who were settling there. Mizpah became the center for Nebuchadnezzar's provincial government in Judah (cf. v. 8). Jerusalem was uninhabitable (cf. Lam. 2:13; 4:1), and Mizpah had been a political and religious center over the centuries (cf. Judg. 20:1-3; 1 Sam. 7:5-14; 10:17).<sup>525</sup>

#### **Gedaliah's leadership of the surviving community 40:7-12**

40:7-8 Several of the Judean guerrilla commanders who had escaped from the Babylonian invaders came to Gedaliah in Mizpah with some of their men when they heard that Nebuchadnezzar had appointed him over the region.

40:9 Gedaliah urged these commanders not to fear the Babylonians but to cooperate with them. If they remained in the land and submitted to Babylonian authority things would go well for them.

40:10 Gedaliah would act as a liaison with the Babylonians, but the commanders could continue to harvest the summer crops as usual in the outlying towns that they had taken over. The Babylonians did not colonize Judah as the Assyrians had Israel (cf. 2 Kings 17:24-27).

40:11-12 When the Jews who had previously fled to surrounding neighbor nations heard how the Babylonians were allowing their brethren to live in the land, they returned and joined in the harvest.

#### **The assassination of Gedaliah 40:13—41:3**

40:13-14 One of the remaining Judean princes, Johanan (cf. v. 8), asked Gedaliah if he was aware that the king of Ammon had encouraged another one of the Judean princes, Ishmael (cf. v. 8), to assassinate him. Baalis, the Ammonite king, shared Zedekiah's antagonism for Babylon (cf. 27:1-11), so he did not want a Babylonian puppet governing Judah. Furthermore, a

<sup>523</sup>See the diagram of Shaphan's descendants near my comments on 26:24.

<sup>524</sup>Harrison, *Jeremiah and . . .*, p. 160.

<sup>525</sup>Some scholars place the site of this Mizpah (lit. watchtower) four miles southwest of Ramah, at Nebi Samwil.

politically unstable condition in Judah would cause Nebuchadnezzar to concentrate his attention and troops there rather than on Ammon. Gedaliah did not believe that any such plot existed.

"Gedaliah had apparently forgotten that Ishmael was of the house of David [as well as a former chief official of Zedekiah's, 41:1] and thus did not appreciate being passed by in Gedaliah's favor. Or Ishmael may have considered Gedaliah a traitor for agreeing to govern under the Babylonians. Baalis [the king of Ammon] may have felt that eliminating Gedaliah would make it easier to carry out his own plans to conquer Judah. The king of Ammon may have feared that Gedaliah might again make Judah a formidable nation and a potential threat to him. Also, Baalis (v. 14), an ally of Zedekiah and an enemy of the Babylonians (cf. 27:3), was angry that the family of Ahikam opposed the league referred to in chapter 27."<sup>526</sup>

- 40:15      Johanan offered to assassinate Ishmael secretly so Gedaliah would not die and harm would not come to the remnant community.
- 40:16      Gedaliah refused to permit Johanan to carry out his plan because he thought he was misjudging Ishmael. Gedaliah was too trusting and naive even though he was a capable ruler and apparently a man of faith. His commitment to his own people seems to have blinded him to the political intrigues that were swirling around him (cf. John 2:24-25). He would have been wise to seek the Lord's will through Jeremiah and then to follow it.
- 41:1-2      In September-October, not long after the fall of Jerusalem, Ishmael and 10 other men came to Mizpah and ate a meal with Gedaliah.<sup>527</sup> During the meal they rose up and slew Nebuchadnezzar's appointee with the sword.<sup>528</sup> This was not only an act of treason but a violation of ancient Near Eastern hospitality customs.
- 41:3      The assassins also murdered the other Jews and the Chaldean soldiers who were there.

"Everything about him [Ishmael] disgraced the name of David his forebear [*sic*], who had resisted every impulse to 'wade through slaughter to a throne' and had awaited God's time and his people's will [1 Sam. 26:10; 2 Sam. 2:1, 4; 5:1]. This was no David but a Jehu—and a Jehu without the excuse of a crusade. Almost as outrageous as his treachery was his folly,

<sup>526</sup>Feinberg, "Jeremiah," p. 628. Ishmael's ancestor Elishama (41:1) was one of David's sons (2 Sam. 5:16).

<sup>527</sup>It is impossible to date this event by year, but most authorities believe it happened quite soon after the fall of Jerusalem (cf. 2 Kings 25:22-26).

<sup>528</sup>Jews in the postexilic period commemorated this event with a yearly fast (Zech. 7:5; 8:19).

in supposing that a regime that was devised in deception, imposed by violence, backed by ill-wishers (Ammon, 40:14; 41:10c) and in breach of God's decree (27:6), could have any hope of survival. It may seem far-fetched to draw parallels between this monster and ourselves; but here, although writ large and in blood, is the way in which even the well-meaning may be tempted to get things done, especially in corporate projects. That is, by guile rather than openness; by pressure rather than patience and prayer; in a word, by carnal weapons rather than spiritual, and towards ends of one's own choosing."<sup>529</sup>

### **Ishmael's further atrocities and Johanan's intervention 41:4-18**

41:4-5 Two days after Gedaliah's murder, before the news of it had spread, 80 religious pilgrims came down from the old towns of Shechem, Shiloh, and Samaria in northern Israel on their way to Jerusalem. Their dress and other signs of mourning (cf. 16:6; 48:37) demonstrated grief over the effects of the Babylonian invasion (cf. Ps. 74; 79; Isa. 63:7—64:12). They may also have been fulfilling a vow. However cutting their flesh was a pagan practice that the Mosaic Law condemned (Lev. 19:28; 21:5; Deut. 14:1; cf. Jer. 16:6). They came with grain and incense to offer to Yahweh in worship. It was probably impossible to make animal sacrifices at the temple site at this time. Evidently there was some continuation of worship in the ruined capital after the temple fell.

"Even the ruins were held to be sacred, just as the Western [Wailing] Wall of the temple in Jerusalem is sacred to this day. Also, a token shrine might have been built."<sup>530</sup>

Since it was the seventh month (September-October, v. 1), the pilgrims probably came to celebrate one or more of the fall festivals.<sup>531</sup> There were some people left in the territory of the old Northern Kingdom who still accepted and remained faithful to Josiah's reforms of 622 B.C. (cf. Deut. 12:5-6; 2 Kings 23:15-20; 2 Chron. 34:9, 33). These pilgrims apparently made a stop in Mizpah to pay their respects to Gedaliah.<sup>532</sup>

41:6 Ishmael went out from Mizpah to meet these men weeping as he went, pretending to share their grief. He invited them to come and see Gedaliah, who was now dead, as a way of trapping them.

---

<sup>529</sup>Kidner, p. 130.

<sup>530</sup>Feinberg, "Jeremiah," p. 631.

<sup>531</sup>The Jews celebrated the feast of Trumpets on the first day of the seventh month, the Day of Atonement on the tenth day of the month, and the feast of Tabernacles (Booths, Ingathering) on the fifteenth through the twenty-second of the month (Lev. 23:23-44). The first two events were optional for Israelites males to attend, and the third was required by the law. The first and third events were feasts, and the second was a fast.

<sup>532</sup>Keown, p. 244.

- 41:7 When they entered Mizpah, Ishmael and his henchmen turned on them, murdered them, and threw their corpses into a cistern. By not explaining his reason for doing so, the text paints Ishmael as a brutal murderer who was bent on carrying out a vendetta against all who had willing contact with Babylon and its representatives.
- 41:8 Ten of the men from the north convinced Ishmael to let them live by claiming that they had a hidden cache of food stored in a field. The Israelites frequently used dry wells and cisterns as underground silos.<sup>533</sup> Apparently Ishmael needed these supplies and so allowed these 10 men to live, at least until he had confiscated their food.
- 41:9 The cistern that Ishmael filled with dead bodies was one that King Asa of Judah had made on account of King Baasha of Israel (cf. 1 Kings 15:22; 2 Chron. 16:6). Good King Asa had made the cistern to preserve life, but wicked Ishmael now polluted it by filling it with corpses. To give these pilgrims such a burial showed no respect for them.
- 41:10 Then Ishmael took captive all the people of Mizpah that Nebuzaradan had placed under Gedaliah's charge including King Zedekiah's daughters (or perhaps women with royal blood).<sup>534</sup> He began to transport all these people to the nation of Ammon, his ally to the east of the Jordan River.
- 41:11 However, Johanan, who had warned Gedaliah to look out for Ishmael (40:13-16), and some remaining guerrilla commanders heard what Ishmael had done.
- 41:12 Johanan, the commanders, and their men pursued Ishmael intending to kill him. They caught up with him by the large pool in Gibeon about three miles southwest of Mizpah (cf. 2 Sam. 2:12-16). Since Gibeon was to the southwest of Mizpah it seems that Ishmael was taking a roundabout way to Ammon. Perhaps he went there to take more captives or to confuse his pursuers.
- 41:13-15 When the captives that Ishmael had taken saw Johanan and his men, they were glad. They forsook Ishmael and joined Johanan. Ishmael, however, escaped to Ammon with eight accomplices.
- 41:16-18 Johanan led the people he had rescued south to Geruth-Chimham (lit. the lodging place of Chimham) near Bethlehem, six miles south of Jerusalem. The location of this place is presently unknown, but it may have been a site that David gave to Chimham in appreciation for Barzillai (cf. 2 Sam. 19:37-40). Johanan and his party intended to proceed to Egypt because

---

<sup>533</sup>Harrison, *Jeremiah and . . .*, p. 162.

<sup>534</sup>Thompson, p. 660.

they feared that the Babylonian soldiers would kill them when they heard that Ishmael had assassinated Gedaliah.

### **The remnant's flight to Egypt 42:1—43:7**

This chapter continues the narrative begun at 41:4. The remnant leaders asked Jeremiah to obtain the Lord's word concerning their proposed flight to Egypt (vv. 1-6).

42:1-3 Then Johanan and his fellow leaders of the refugees asked Jeremiah to pray for them, as few as they were, that the Lord would tell them what to do. Zedekiah had made a similar request of Jeremiah and then chose to go against what the Lord commanded (37:3).

Many expositors believe that the remnant had already determined to proceed on to Egypt and simply wanted Yahweh's blessing (cf. 43:1-3).

"Sometimes God's people take this false approach in discerning the will of God. Instead of honestly seeking God's will, they go from counselor to counselor, asking for advice and hoping they'll find somebody who will agree with their hidden agenda."<sup>535</sup>

I tend to think their request was sincere in view of their words and the Lord's reply. It seems to me that if they had already decided to leave the land the Lord would have responded to them more strongly as hypocrites instead of as people who were in the process of making a decision.

42:4 Jeremiah agreed to seek the Lord's guidance and to report what He said to the remnant.

42:5-6 The people promised three times that they would obey the Lord, the faithful and true witness, in all that He told them to do so things would go well for them.

Jeremiah obtained and reported the Lord's message to the remnant camped near Bethlehem (vv. 7-22).

42:7-8 After 10 days word came back to Jeremiah from Yahweh, so he assembled all the people to tell them God's will. Perhaps the Lord waited this long to respond to see if the people would wait for His word or proceed on to Egypt without it.

42:9-10 The Lord told the people, in classic covenant terminology, that if they remained in the land He would build them up and plant them firmly (cf. 1:10; 24:6; 31:28; Deut. 28). He would also lessen His punishment of

---

<sup>535</sup>Wiersbe, p. 133.

them for their former disobedience that had resulted in the Babylonian invasion (cf. 18:18).

42:11-12 The Lord told them not to fear Nebuchadnezzar because He, the ultimate sovereign, would be with them to save and deliver them from Nebuchadnezzar's hand. Yahweh would have compassion on the people and cause Nebuchadnezzar to have compassion on them and allow them to stay in their land.

42:13-16 However if the people decided to leave the land and not listen to the Lord's voice, if they chose to go to Egypt where they thought they would be safe and have plenty of food, they would surely die by the sword, famine, and disease there. The Lord made His will very clear to the remnant. None of them would survive the calamity He would bring on them.

"Just as Yahweh's sovereignty can insure the safety of the faithful against repercussions from the king of Babylon, so will the judgment of Yahweh reach even to Egypt."<sup>536</sup>

42:18 As the Lord had dealt with the people of Judah and Jerusalem in the invasion, so He would deal with the remnant if they went to Egypt. He would pour out His wrath on them when they entered Egypt, they would become a terrible object lesson to others, and they would never return to the Promised Land.

42:19-20 Jeremiah added that his hearers should understand that the Lord was clearly telling them not to go to Egypt. He also reminded them that they had asked him to secure God's directions for them in prayer and had promised to do whatever He commanded.

42:21-22 The prophet sensed by the people's reaction that they were not going to obey, so he warned them again that they would die in Egypt if they went there.

The leaders of the remnant rejected the Lord's direction (43:1-7).

43:1-3 As soon as Jeremiah had finished telling the remnant what God's will was, Azariah, Johanan, and other arrogant men among them accused Jeremiah of lying to them. They claimed that Baruch was the source of the advice Jeremiah had given them rather than Yahweh. They believed that Baruch wanted the Chaldeans to slay or exile them. Baruch was Jeremiah's scribe, and both men were loyal to Yahweh (cf. ch. 45). Perhaps these opponents felt that Baruch was unduly influencing the prophet.

---

<sup>536</sup>Keown, p. 251.



"Here is a good example of a man [Azariah] who was so persuaded that his own wrong views were right that his mind was completely closed to any other possibility—an age-old phenomenon."<sup>537</sup>

43:4 Johanan, the guerrilla commanders, and all the refugees did not obey Yahweh's instruction to stay in the land. All the people in view here must be all the people in this group of Judahites near Bethlehem, not all the people still in the land. Many Judeans remained in the land and did not go to Egypt. Here was a final moment of opportunity for the Judahites still in the land, but they continued to reject the Lord's word.

43:5-7 These leaders took this remnant, which included Jews who had returned to the land from neighboring countries, Jews whom the Babylonians had left in the land, Jeremiah, and Baruch, and proceeded to Egypt. They stopped at Tahpanhes (Gr. Daphne; cf. 2:16), an Egyptian frontier town in the northeastern Nile Delta region on the road from Canaan, perhaps to obtain permission to settle in the land.<sup>538</sup> They did this in disobedience to the Lord. Note the continued emphasis on the people's disobedience throughout this whole chapter.

"Think of it! Abraham's descendants returned to Egypt long after their liberation from it. With great suffering they had been delivered from their bondage in Egypt only to return there a defeated and hopeless remnant nearly nine hundred years later . . ."<sup>539</sup>

It is difficult to tell whether Jeremiah went with them as a prisoner or by his own choice. It seems unlikely that this group of rebels against God's messages through Jeremiah would have forced him (and Baruch) to accompany them knowing that he would continue to be a thorn in their side. If Jeremiah went to Egypt by his own choice, he must have done so convinced that Yahweh wanted him to be His voice among the rebels. He could not have gone to escape danger and have been faithful to his Lord. Many of the commentators speculate that he did not go voluntarily (cf. 32:6-15; 40:1-6; 42:13-18).

### **Events in Egypt 43:8—45:5**

As the remnant moved from Judah to Egypt, so does the narrative.

#### **Jeremiah's prediction of Nebuchadnezzar's invasion of Egypt 43:8-13**

43:8 The Lord continued to give prophetic messages to Jeremiah in Egypt.

---

<sup>537</sup>Thompson, p. 668.

<sup>538</sup>See the map of the ancient Near East at the end of these notes.

<sup>539</sup>Feinberg, "Jeremiah," p. 637.

43:9 Yahweh instructed Jeremiah to perform another symbolic act (cf. 13:4-7; 19:1-13; 27:1—28:16; Ezek. 4:1-12; 5:1-4; 12:3-6, 18; 37:15-17). He was to hide some large stones in the mortar of the brick courtyard in front of an official government building or royal residence in Tahpanhes while some of the Judahites watched.<sup>540</sup> Perhaps the large stones symbolized the foundation of Nebuchadnezzar's future throne (v. 10) or the Jews over whom Nebuchadnezzar would rule.

"Sir Flinders Petrie, who excavated Tell Defenneh, found a large paved area which he believed to be the one referred to here. It was situated in front of what he identified as Pharaoh's house, and was probably used as an unloading and storage area."<sup>541</sup>

43:10 Jeremiah was then to tell the Judahites that Yahweh was going to bring Nebuchadnezzar, His servant (cf. 27:6; 45:9; Isa. 44:28), into Egypt. The Babylonian king would set up his throne and his royal canopy (or carpet) right over the place where Jeremiah had imbedded his stones.<sup>542</sup>

43:11 Nebuchadnezzar would fight the Egyptians. Those whom the Lord appointed for death would die, those He appointed for captivity would go into captivity, and those He appointed for battle would participate in battle.

"The meaning of the parable . . . is clear. Though the Judean refugees have buried themselves in populous Egypt, they will be discovered and feel, as their compatriots had done, the weight of Babylonian might."<sup>543</sup>

43:12 Nebuchadnezzar would do to Egypt what he had done to Judah. He would burn down the Egyptian temples and take people captive. He would capture Egypt as easily as a shepherd wraps himself with a garment, and he would depart from Egypt in safety.<sup>544</sup>

Nebuchadnezzar invaded Egypt about 568-567 B.C. and defeated Pharaoh Ahmose (Gr. Amasis, 570-526 B.C.; cf. Ezek. 29:17-20).<sup>545</sup>

---

<sup>540</sup>J. Bright, *Jeremiah*, p. 263, wrote that Pharaoh had a royal residence in Tahpanhes as well as at Elephantine, an island in the Nile River on the southern frontier of Egypt near modern Aswan.

<sup>541</sup>Graybill, p. 686.

<sup>542</sup>The Hebrew word *shapriro*, translated "canopy," occurs nowhere else in the Bible, and its meaning is debatable.

<sup>543</sup>Harrison, *Jeremiah and . . .*, p. 165.

<sup>544</sup>Some translations yield the image of the shepherd picking his cloak clean of lice, which is possibly what Jeremiah intended. In this case the figure is probably of Nebuchadnezzar picking his prey clean.

<sup>545</sup>See Pritchard, ed., p. 308.

43:13 Nebuchadnezzar would also break down the obelisks that stood at On (Gr. Heliopolis), the Egyptian city of the sun about five miles northeast of modern Cairo. And he would burn the temples of the gods of Egypt. Heliopolis was the site of the famous temple of Amon-Re, the sun god, which people approached by passing between two rows of obelisks.<sup>546</sup> Egyptian obelisks were sacred monuments that honored various pagan gods. As Moses, the servant of the Lord, had humiliated the gods of Egypt at the Exodus, so Nebuchadnezzar, a Gentile servant of the Lord, would humiliate them again.

### **The continuing hardness of God's people ch. 44**

This chapter records an incident late in Jeremiah's ministry, though how much later than chapter 43 is unknown. Many commentators suppose it dates from about 580 B.C. because it would have taken some time for the Judean refugees to spread throughout Egypt, as this chapter pictures them. This chapter contains the prophet's last known words.<sup>547</sup>

Jeremiah announced Yahweh's judgment on the idolatrous Jews in Egypt (vv. 1-14). Israel's future lay with the Jews in exile in Babylon, not with those who had fled to Egypt for safety or with the small remnant left in Canaan.

44:1 The Jewish refugees did not all stay in Tahpanhes. Some of them moved on and took up residence in the Egyptian towns of Migdol (probably about 25 miles east-northeast of Tahpanhes; cf. Exod. 14:2; Num 33:7; Ezek. 29:10; 30:6), Noph (Gr. Memphis, the chief city of lower or northern Egypt, about 13 miles south of Cairo on the western bank of the Nile), and in the territory of Pathros (lit. land of the south, i.e., upper or southern Egypt; cf. 44:15).<sup>548</sup> Other Jews had migrated to Egypt earlier to escape the Babylonians. The Lord gave Jeremiah another message for all of them.

44:2-3 Yahweh reminded His chosen people that He had brought calamity on Jerusalem and Judah and that the land lay in ruins. He had done this because of their wicked, idolatrous practices.

44:4-6 This destruction had come after the Lord had sent His servants the prophets repeatedly to warn the people that He hated what they were doing. Yet they did not listen and repent; they did not stop sacrificing to

---

<sup>546</sup>Thompson, p. 671. Only one of these obelisks still stands on the site. One of them is now in Central Park in New York City, and another is on the Thames Embankment in London. Both are wrongly called "Cleopatra's Needle." Graybill, p. 686.

<sup>547</sup>The prophecies in the succeeding chapters date from earlier times.

<sup>548</sup>A sizable Jewish community existed at Elephantine, in the Pathros region, during the fifth century B.C. Archaeologists have discovered important documents there that provide helpful information about their society. Their cult consisted of a mixture of Israelite and Canaanite religious elements. See A. Cowley, *Aramaic Papyri of the Fifth Century B.C.*

pagan gods. Their failure to repent was the cause of the destruction of Judah and Jerusalem.

44:7-8 The Lord asked why, then, His people continued to practice idolatry in Egypt. They were doing there what they had done in Judah that had resulted in Yahweh's judgment of them. If they continued to practice idolatry, the Lord would cut them off completely and would make them an object of ridicule.

44:9-10 He asked if they had forgotten the wickedness of all the people in Judah: their ancestors, the kings and their wives, and themselves and their wives. They had failed to feel contrite or to repent even to the present day.<sup>549</sup> They had not feared Yahweh or obeyed His covenant. They were arrogant, stubborn, and hard-hearted.

"It was Hegel, in the introduction to his *Philosophy of History* (1807), who rightly said: 'What experience and history teach is this—that people and governments never have learned anything from history, or acted on principles deduced from it.' So with these Jews in Egypt!"<sup>550</sup>

44:11-12 Yahweh, Israel's God, announced that He would oppose His people with unyielding judgment and cut off the entire Jewish community that had fled to Egypt. All these Jews would die by war or famine and would become illustrations for the other nations of what it means to be cursed. There would be no difference between the fate of the powerful and the poor among those whom God judged.

44:13-14 The Lord would punish His people in Egypt as He had punished them in Judah, with warfare, starvation, and disease. All but a few refugees of the remnant who had fled to Egypt to live there temporarily and then return to Judah would die in Egypt. They would not return to the Promised Land. Thus this judgment had as its focus those who fled to Egypt for temporary asylum, not all the Jews who had moved there earlier and had made it their permanent home.

The Jews then responded to Jeremiah's prophecy (vv. 15-19). We do not know how Jeremiah communicated his message to all the Jews throughout Egypt. He may have done so at a nationwide gathering, or he may have sent his prophecy to their settlements by messengers.

44:15-16 The Jews to whom this message came replied that they were not going to listen to Jeremiah. The wives of many of the Jewish men were burning

---

<sup>549</sup>The same Hebrew word translated "contrite" here, *dukke'u*, has been rendered "bruised" in Isa. 53:5.

<sup>550</sup>Feinberg, "Jeremiah," pp. 640-41.

sacrifices to pagan deities, with their husbands' knowledge, along with other women.

44:17-18 They intended to continue to worship the Queen of Heaven, a Near Eastern fertility goddess, as they had done in Judah (cf. 7:18; 2 Kings 17:16) because then they had plenty of food and life was pleasant for them.<sup>551</sup> Worship of this deity involved offering cakes made in the shape of the goddess or the moon, or stamped with her image (v. 19; cf. 7:18). Since the Judeans had stopped making burnt offerings and drink offerings to her they had experienced shortages, and many of them had died in war and famine. Their response challenged Yahweh's ultimate sovereignty.

During the long and relatively peaceful reign of evil King Manasseh (697-642 B.C.), pagan cults of many kinds flourished in Judah. When Josiah (640-609 B.C.) assumed the throne after wicked King Amon's brief reign (642-640 B.C.), he began to expel the cults and encourage Yahweh worship. Then a series of bad things began to happen in Judah. Pharaoh Neco killed Josiah, the Egyptians occupied Judah, and the Egyptians carried King Jehohaz away as a prisoner. Then Nebuchadnezzar invaded Judah several times, deported King Jehoiakim, destroyed Jerusalem, and took many Judeans captive including King Zedekiah. Most recently Ishmael had assassinated the new Judean governor, Gedaliah. It is understandable that so many of the people concluded that returning to Yahweh in Josiah's day had been a step backward for Judah. They failed to see that these calamities were punishments from Yahweh for forsaking Him and concluded that they were punishments from the idols for forsaking them.

"On a more doctrinaire plane, the secularist will blame Christianity, not the lack of it, for many of society's ills, ascribing our frustrations and tensions to the biblical restraints and moral absolutes; seeking freedom, as did Jeremiah's critics, not in God but from God."<sup>552</sup>

44:19 The women had carried on these idolatrous worship practices with their husbands' full knowledge and approval (cf. 7:17-19). This was not just a women's sin. The women seem to have meant that since their husbands approved of their actions (cf. Num. 30:7-15), why should Jeremiah object? As in Solomon's household, the women seem to have been very aggressive in pursuing idolatry, and their husbands followed their lead (cf. 1 Kings 11:1-8).

---

<sup>551</sup>See Keown, pp. 266-68, for a study on the Queen of Heaven.

<sup>552</sup>Kidner, p. 133. Similarly, some people in our day point to Christianity as the cause of the bad conditions that existed in the Middle Ages, since the Roman Catholic church dominated life then. Really those bad conditions resulted from a combination of causes.

Jeremiah then replied to the people (vv. 20-30).

44:20-23 The prophet reminded the people that Yahweh had devastated their homeland because of their idolatry. What they and their forefathers had done had not escaped His notice. It was a direct result of their accumulated sins. Covenant unfaithfulness had resulted in their present calamity.

44:24-27 Jeremiah proclaimed a further message from Yahweh to them. If they continued to practice idolatry, they would all die. They would not be able to invoke the Lord's name as their highest authority as they had since they became a nation because they would be dead. Again, the focus of this judgment was particularly the remnant that had recently fled from Judah and planned to return as soon as possible (cf. v. 14).

44:28 Only a few of the Judean remnant living in Egypt would survive (cf. v. 14). The Lord's people then would know whose word was true. They had said if they worshipped the Queen of Heaven they would prosper, but He had said they would perish.

Many Jews continued to live in Egypt for hundreds of years after these events.<sup>553</sup> This may indicate that many of the Jews repented at Jeremiah's preaching and that God spared them, but this is unlikely. Probably the Lord slew the Jews who had fled to Egypt with Johanan.

44:29-30 The Lord promised His people a sign that what He had said would happen. Pharaoh Hophra (Gr. Apries, ca. 589-570 B.C.) would experience a fate that would be the same as that of King Zedekiah. This was the Pharaoh who had promised support to Zedekiah but was turned back by Nebuchadnezzar in 588 B.C. when his army advanced into Judah (cf. 37:5). As Zedekiah had fallen to his enemy, so would Hophra. According to the Greek historian Herodotus, Hophra became the target of a *coup d'état* and Amasis, one of his generals, took his place. Hophra died later when Amasis handed him over to Egyptians who strangled him.<sup>554</sup> Josephus, however, wrote that Nebuchadnezzar slew him and reigned in his place.<sup>555</sup> Perhaps Nebuchadnezzar was the influential power behind Amasis' revolt and was, therefore, ultimately responsible for Hophra's death.

"In one of the strongest examples of direct defiance against Yahweh by Israel/Judah portrayed in the Hebrew Bible, Jer 44 underscores the inevitable judgment that will fall upon the Judean survivors in Egypt. The

<sup>553</sup>See J. P. Lange, ed., *A Commentary on the Holy Scriptures*, vol. 6: *The Book of the Prophet Jeremiah Theologically and Homiletically Expounded*, by E. W. Eduard Naegelsback, p. 356, for a brief history of Jewish life in Egypt until the time of Christ.

<sup>554</sup>Herodotus, *History*, 2:161-63; 4:159.

<sup>555</sup>Josephus, 10:9:7.

concluding passage in Jer 37—44 seals forever the fate of the Judean community that sought safety in Egypt."<sup>556</sup>

It also serves as a final strong warning against the practice of idolatry, which the preceding chapters of this book emphasized repeatedly.

Scripture gives no information about Jeremiah's personal history after this, his last prophecy. There is ancient tradition that he died in Egypt, but other traditions about the later events in his life are fanciful and make it very dangerous to speculate further.<sup>557</sup> Like the Book of Acts, Jeremiah does not record the death of its main character.

". . . though in a sense one's earthly ministry comes to a close, its fruits continue in time and eternity."<sup>558</sup>

### **Baruch's despair and consolation ch. 45**

This chapter belongs after chapter 36 chronologically, either after 36:8 or 36:32. It serves as an appendix to the historical incidents recorded there. Perhaps the writer or final editor placed it here to show that Yahweh exempted faithful Baruch from the threats to the Judean remnant recorded in chapter 44.

"Probably Jeremiah placed this chapter last in his prophecies to Judah (Jer. 2—45) to emphasize the response that God wanted from godly Jews during the Exile."<sup>559</sup>

This short chapter provides insight into Baruch's life.<sup>560</sup> It is also the last chapter in the book in which Jeremiah is part of the narrative.

- 45:1-2      The Lord had given Jeremiah a message for Baruch after he had copied Jeremiah's prophecies in 605 B.C. (ch. 36). Which copying this was is unimportant, the first one referred to in 36:8 or the second one in 36:32.
- 45:3        Baruch had complained about the sorrow, pain, inner turmoil, and restlessness that he had experienced because he carried out God's will. He had copied Jeremiah's prophecies and had suffered from his association with their negative message. His lament recalls Jeremiah's "confessions" and some of the personal lament psalms.
- 45:4        The Lord was about to tear down and uproot Judah (cf. 1:10; 2:21; 31:5; et al.).

---

<sup>556</sup>Keown, p. 269.

<sup>557</sup>See Feinberg, "Jeremiah," pp. 644-45, for some of these traditions.

<sup>558</sup>Jensen, p. 110.

<sup>559</sup>Dyer, "Jeremiah," p. 1192.

<sup>560</sup>For other references to Baruch in Jeremiah, see 32:12-13, 16; 36:4-5, 8, 10, 13-19, 26-27, 32; and 43:6.

45:5 It was wrong, therefore, for Baruch to expect a life of comfort and ease. Baruch was an educated man whose brother was a high official under King Zedekiah (51:59). His grandfather had been the governor of Jerusalem during Josiah's reign (cf. 32:12; 2 Chron. 34:8). He may have entertained hopes of attaining a position of distinction in the nation, but he, too, would have to participate in the fallout of Yahweh's judgment. The Lord promised to bless Baruch by preserving his life wherever he went because of his faithful service.

"Ironically, the very suffering through which Baruch passed because of his loyalty to Jeremiah gained him honor beyond anything he could have anticipated."<sup>561</sup>

"A crisis doesn't 'make a person'; a crisis reveals what a person is made of."<sup>562</sup>

The Lord's command not to seek great things for himself presupposes a proud motive. Seeking to serve the Lord in a significant position of ministry is not wrong in itself provided one's motive is to glorify God. It is seeking position for one's own glory that is wrong.

### **III. PROPHECIES ABOUT THE NATIONS CHS. 46—51**

In Jeremiah, prophecies concerning foreign nations come at the end of the book. In the other major prophets, Isaiah and Ezekiel, they come after oracles against Israel and or Judah and before oracles dealing with Israel's restoration. Oracles against foreign nations appear in every prophetic book except Hosea. Collections of them appear in Amos 1—2, Isaiah 13—23, Ezekiel 25—32, and Zephaniah 2:2-15, as well as here. Jeremiah follows a generally geographical order dealing first with a nation in the west and then moving east.<sup>563</sup> The fact that the prophets of Israel and Judah gave oracles about other nations reflects Yahweh's sovereignty over the whole world.

"The OAN [oracles against nations] had three main purposes: (1) to pronounce doom on a foreign nation, sometimes for mistreatment of Israel; (2) to serve as a salvation oracle or oracle of encouragement for Israel; (3) to warn Israel about depending on foreign alliances for their security . . .

"While in some OAN in the prophetic books foreign nations are condemned for their mistreatment of Israel and Judah, it is remarkable that, with the exception of the Babylon oracle . . ., none of the foreign nations in the OAN in Jeremiah is to be judged for such mistreatment. The oracles are not clearly nationalistically motivated, and thus it cannot be

<sup>561</sup>Thompson, p. 684.

<sup>562</sup>Wiersbe, p. 135.

<sup>563</sup>See the maps at the end of these notes for the locations of some places mentioned in these chapters.



shown that they functioned primarily, if at all, as salvation oracles for Judah. In six of the oracles in Jer 46—49, no reasons are given for judgment. The language about destruction is not strident; it gives no hint of xenophobic hatred. . . ."564

By common scholarly consensus, these chapters contain some of the finest Hebrew poetry in the Old Testament. The canonical arrangement of these oracles reflects general movement from Egypt in the southwest to Babylon in the northeast.

### **A. THE ORACLE AGAINST EGYPT CH. 46**

This chapter on Egypt contains three separate prophecies that Jeremiah delivered about the fate of that nation. Their purpose seems to have been to discourage King Jehoiakim (609-598 B.C.) and the pro-Egyptian party in Judah from forming an alliance with Egypt.

The first prophecy announced Egypt's defeat at Carchemish (vv. 1-12).

46:1            This verse serves as a title for the whole section to follow (i.e., chs. 46—51; cf. 14:1; 47:1; 49:34).

46:2            This is a title verse for the subsection dealing with Nebuchadnezzar's defeat of Pharaoh Neco at Carchemish (lit. fort of Chemosh, the god of the Moabites) in 605 B.C. (vv. 1-12). Jeremiah's prophecy apparently came after Neco's defeat, but it is possible that the English past tense (Heb. perfect tense) describes the future as certain.

Egypt controlled Canaan and Aramea (Syria) during most of the second millennium B.C. until about 1200 when internal weakness resulted in her losing her grip. Assyria, then Babylonia, then Persia took over control of this region in turn. But Egypt was still a force to be reckoned with even after she lost the upper hand. One particularly strong Egyptian Pharaoh was Shishak (945-924 B.C.) who invaded Canaan (cf. 1 Kings 14:25-26). In 609 B.C. Pharaoh Neco II (ca. 610-594 B.C.) marched to Carchemish on the Euphrates River in northern Syria (modern Turkey). On the way, King Josiah opposed him, and Neco slew the Judean king (609 B.C., 2 Kings 23:29). Neco wanted to assist the Assyrians in defeating the young and threatening Neo-Babylonian Empire, but the Babylonians, led by Prince Nebuchadnezzar, won the battle in 605 B.C. This is the victory that gave Babylonia sovereignty in the ancient Near East.

46:3-4        Jeremiah called the Egyptian infantry and cavalry soldiers to prepare for battle.

---

<sup>564</sup>Thomas G. Smothers, *Jeremiah 26—52*, pp. 275, 277. Smothers wrote the commentary on chapters 46—51 in this volume, which appears in the bibliography under Keown, Scalise, and Smothers.

- 46:5 He soon expressed shock, however, at seeing the Egyptians terrified and retreating.<sup>565</sup>
- 46:6 He called the Babylonians not to allow any of the Egyptians to escape.
- 46:7-8 Jeremiah asked who this was who was trying to imitate the Nile River by overwhelming its enemy. Egyptian soldiers evidently thought of themselves as capable of arising in battle like the Nile River arose during flooding. Pharaoh's proud and unrealistic intent was to sweep the enemy away (cf. Isa. 8:7-8).
- 46:9 The Egyptians and their allies, the Ethiopians, Libyans (or possibly residents of modern Somalia), and Lydians (cf. Isa. 66:19; or North Africans, cf. Gen. 10:13; Nah. 3:9) pressed the battle (cf. Ezek. 30:5).<sup>566</sup>
- 46:10 The outcome of the battle was up to sovereign Yahweh, the God of armies. He would use it to accomplish a slaughter according to His will. Part of His vengeance may have been over Neco's killing of King Josiah. The "day" in view is the day God would judge the nation; it has no eschatological connotation.
- 46:11 The prophet counseled the wounded Egyptians to go to Gilead to obtain healing balm (cf. 8:22; 46:11; 51:8; Gen. 37:25), but she would not recover from the wounds Yahweh had allowed her to sustain. It was ironic that Egypt could not heal herself since she boasted the most advanced medical arts in antiquity. Comparing Egypt to a virgin stressed her vulnerable and pitiable condition (cf. 14:17; 18:13; 31:4, 21).
- 46:12 The nations had heard of Egypt's defeat and her cry as she sought to save herself.

The second prophecy predicted Nebuchadnezzar's conquest of Egypt (vv. 13-24).

Shortly after the battle of Carchemish, Nebuchadnezzar returned to Babylon for his coronation. His father Nabopolassar had died in August of 605 B.C. Almost immediately Nebuchadnezzar returned to Palestine with his army to subdue Canaan. From there he moved west against Egypt about 568-567 B.C.

- 46:13 This is a title verse describing the prophecy about Nebuchadnezzar's invasion of Egypt that follows.

---

<sup>565</sup>For the expression "terror on every side," see 6:25; 20:3, 10; Ps. 31:13. According to Thompson, p. 688, this may have been a proverbial curse formula.

<sup>566</sup>Modern Somalia is east and south of Ethiopia. Libya was Egypt's neighbor to the west, and the Lydian Kingdom was in Anatolia (modern western Turkey).

- 46:14 Warnings were to go out to the major cities of Egypt that the same army that had devoured nations around her was coming. The cities are the same as those mentioned in 43:7-9 and 44:1 where Judeans had fled for safety (cf. 2:16).
- 46:15-16 The Egyptian gods were unable to stand against the aggressor. The bulls of Egypt, symbols of the nation, its gods, and its leaders, were in humiliating retreat. The Lord had overthrown them repeatedly. The allies of Egypt would speak of going home.
- "In this oracle it is deity against deity, bull against bull, king against king."<sup>567</sup>
- 46:17 The allies concluded that Pharaoh was nothing but talk since he had failed to defend his nation in a timely fashion.
- "Hophra was a big noise who seemed adept at missing the appointed time [cf. 37:5-6]."<sup>568</sup>
- 46:18 The true King, Yahweh of hosts, promised that an enemy would come against Egypt, and it would be as imposing as a mountain. Mount Tabor, which stood 1800 feet tall and towered over the Jezreel Valley below, and Mount Carmel, which rose 1700 feet beside the Mediterranean Sea, were such mountains.
- 46:19 The Egyptians had better pack their bags because the enemy would destroy Noph (Gr. Memphis), the capital of Lower Egypt, and burn it down. The Babylonians did this to Jerusalem too.
- 46:20 The enemy from the north would attack Egypt and leave a wound, like a horsefly stinging a heifer. This may be an ironical poke at Egypt since one of its deities was Apis the sacred bull.
- 46:21 The mercenary soldiers that the Egyptians hired to help them would turn and run from the enemy like fat, pampered calves. They would die like sacrificial animals because the Lord would punish them too.
- "The mercenaries mentioned were Ionians and Carians whom [Pharaoh] Psammeticus had hired, and had been retained by his successors."<sup>569</sup>
- 46:22 The enemy would advance against Egypt as relentlessly as an army of lumberjacks with axes, but Egypt would only be able to hiss like a snake

---

<sup>567</sup>Smothers, p. 293.

<sup>568</sup>Thompson, p. 692.

<sup>569</sup>Harrison, *Jeremiah and . . .*, p. 172.

at the foe. The snake was important in Egyptian religion and was a symbol of Pharaoh and the nation.

- 46:23 The innumerable enemy soldiers would cut down all the trees to use in their warfare against the Egyptians. Their coming would resemble an invasion of locusts.
- 46:24 Like a young girl taken captive against her will, Egypt would suffer shame when the power from the north conquered her.

The third prophecy against Egypt promised the humiliation of Egypt and the deliverance of Israel (vv. 25-28).

- 46:25 The sovereign Yahweh, Israel's God, announced that He would punish the gods, rulers, and people of Egypt. Amon was the chief deity of No (Gr. Thebes), the capital of Upper Egypt. Even though there is as yet no historical evidence that Nebuchadnezzar advanced this far in his conquest of Egypt, his invasion affected the whole nation.
- 46:26 The Lord would hand the nation over to Nebuchadnezzar who would kill the people. The crisis would pass, however, and life would eventually return to normal (cf. 48:47; 49:6, 39; Isa. 19:19-25; Ps. 87:4). This occurred later in Egypt's history, and the promise probably anticipates millennial conditions (cf. 48:47; 49:39).<sup>570</sup>
- 46:27 The Israelites should take courage because the Lord promised to save them from afar and to bring them back from their place of captivity. Contrary Jacob would return to his land and enjoy undisturbed security. The Israelites would experience restoration as well as the Egyptians (vv. 25-26; cf. 30:10-11; Isa. 41:8-13). As in the preceding verse, eschatological blessings seem clearly to be in view.
- 46:28 The Lord's servant Jacob should not fear because Yahweh would be with His people. He would punish the nations where He had sent them. He would not completely annihilate the Israelites but would punish them severely. Israel would have a bright future as a nation.

"It is important to note that nowhere in these oracles is there the suggestion that Egypt faced disaster because of her mistreatment of Israel/Judah. There is no expression of hatred or vengeance against Egypt, although satire, irony, and the taunt are fully in evidence. Egypt is judged for pride and aggression as is typical in other oracles concerning the nations. In fact it is doubtful that these oracles were intended for Egyptian ears. Rather the purpose of the oracles was to lead the kings of Judah away

---

<sup>570</sup>See Dyer, "Jeremiah," p. 1193.

from dependence on Egypt and toward the acceptance of vassalage to Babylon so that the nation might live."<sup>571</sup>

**B. THE ORACLE AGAINST THE PHILISTINES CH. 47**

It is not possible to date this oracle exactly, but Jeremiah evidently gave it sometime during Josiah's reign (640-609 B.C.; v. 1).

- 47:1 Jeremiah received a message from the Lord concerning the Philistines before Pharaoh conquered Gaza in 609 or 601 B.C.<sup>572</sup> The 609 B.C. date is more probable since we know that Nebuchadnezzar invaded Ashkelon in 604 B.C., and an invasion of that town was still in the future when Jeremiah gave this oracle (cf. v. 7).
- 47:2 An invader from the north would sweep in like a flood and overwhelm the land and Gaza. Everyone would bewail this situation. After the battle of Carchemish in 605 B.C. the likely invader would have been Babylon, but this oracle may date from before that battle.
- 47:3 The invading horses and chariots would so terrorize the people that parents would not even think to protect their children. They would be too concerned to find safety themselves in the panic.
- 47:4 The day would come when the Lord would use this enemy to destroy all the Philistines who had originally fled to Canaan from the islands of the northeastern Mediterranean, particularly Crete (cf. Deut. 2:23; Amos 9:7).<sup>573</sup> Yahweh would cut off Tyre and Sidon, north of the Philistine coast in Phoenicia, from all their allies. Perhaps Tyre and Sidon were allies of the Philistines at this time and therefore fell under their judgment.
- 47:5 Gaza and Ashkelon, in the southern part of Philistia, would suffer ruin, and the Philistines in that area would mourn and wail for a long time. Shaving the head and cutting oneself were signs of mourning (cf. 16:6; 41:5; 48:37).
- 47:6 Jeremiah called on the Lord to sheath His sword, to stop the slaying. The prophet did not relish the prospect of such a slaughter.
- 47:7 Then Jeremiah remembered that the Lord's sword (the invader from the north) had to continue to slay the Philistines until it had finished the job

---

<sup>571</sup>Smothers, p. 296.

<sup>572</sup>Herodotus, 2:159, mentioned that Pharaoh Necho conquered Gaza (Gr. Kadytis) in 609 B.C., and the *Chronicles of the Chaldean Kings* indicate that Necho may have attacked and defeated Gaza in 601 B.C. See Wiseman, pp. 23-25, 67-69. See Feinberg, "Jeremiah," pp. 654-55; Graybill, p. 688; or Dyer, "Jeremiah," p. 1194, for a brief history of the Philistines.

<sup>573</sup>This is not a reference to the eschatological day of the Lord.

He had given it to do. Nebuchadnezzar may have fulfilled this prophecy in 604 B.C. when he destroyed Ashkelon.<sup>574</sup> It was the sacking of Ashkelon at this time that precipitated a fast in Jerusalem during Jehoiakim's reign, which led to the reading and burning of Jeremiah's scroll (cf. ch. 36).

"A Babylonian prism, now in Istanbul, mentions the presence—presumably with little choice in the matter—of the kings of Tyre and Sidon (cf. v. 4), of Gaza (5) and of Ashdod, at the court of Nebuchadnezzar; while a prison list now in Berlin records the rations for the king of Ashkelon (5), among other noted prisoners (including Jehoiachin of Judah)."<sup>575</sup>

### **C. THE ORACLE AGAINST MOAB CH. 48**

This oracle is similar to the one in Isaiah 15 and 16.<sup>576</sup> Other oracles against Moab appear in Ezekiel 25:8-11, Amos 2:1-3, and Zephaniah 2:9, but this is the longest one. It is very difficult to say when Jeremiah gave this oracle, but it may have been one complete message.

"Moab joined in the marauding bands Nebuchadnezzar sent against Judah in 602 B.C., after Jehoiakim's revolt (cf. 2 Kings 24:2; Jer 12:7-13). They joined in a plot to revolt against Babylon early in Zedekiah's reign (cf. 27:1-11)."<sup>577</sup>

The oracle begins with a general prediction of Moab's destruction (vv. 1-10).

48:1 The Lord announced the destruction of two key cities in Moab, which was Judah's neighbor to the southeast, Nebo (Num. 32:3, 38) and Kiriathaim (Josh. 13:19).<sup>578</sup> Moab's boundaries were the Arnon River on the north, the Arabian Desert on the east, the Zered River on the south, and the Dead Sea on the west. At various times Moab occupied territory to its north, in the old Amorite kingdom of Sihon (Num. 21:21-31).

48:2 Heshbon, the ancient capital of the Amorites (Num. 21:25-30), would be the place where an enemy would plan Moab's destruction. It stood at the northernmost boundary of Moab during periods of Moab's expansion.<sup>579</sup> Madmen, another important Moabite town two miles northwest of Rabbah, would be the victim of warfare.

<sup>574</sup>See Wiseman, pp. 68-69.

<sup>575</sup>Kidner, p. 141. See Pritchard, ed., p. 308, for extracts from both lists.

<sup>576</sup>See Feinberg, "Jeremiah," p. 662, for a chart of the similar verses.

<sup>577</sup>Ibid., p. 656. See Harrison, *Jeremiah and . . .*, p. 174, for a brief history of Moab.

<sup>578</sup>The Moabite (or Mesha) Stone, erected about 840 B.C. but now in the British Museum, refers to many of the numerous Moabite towns mentioned in this chapter. For a translation of it, see Pritchard, ed., pp. 320-21.

<sup>579</sup>Smothers, p. 311.

- 48:3-5 The town of Horonaim would also experience great devastation. Moab's children would wail because of the calamity of battle. The hills near Luhith and Horonaim would witness the cries of their inhabitants. These sites were in southwestern Moab.
- 48:6 The Moabites would need to flee for their lives. They would be as rare, isolated, and forsaken as juniper trees in the desert, and their safety would lie in their isolation.
- 48:7 The reason for Moab's destruction was her self-confidence in her deeds and riches. Yet even she would undergo capture. Moab's chief god, Chemosh, would go into captivity along with his priests and the princes of the nation. It was customary for conquerors to carry off images of the gods of the people they defeated (cf. 49:3; Isa. 46:1-2; Amos 5:25).
- 48:8 All the cities, the valley, and the plateau—in short, the whole nation—would fall before the coming enemy, as Yahweh predicted. The valley was the Jordan Valley in which Moab had holdings, and the plateau refers to the tableland from Aroer northward to Heshbon (cf. Josh. 13:15-17). Most of Moab stood on this fertile plateau.
- "For defense, Moab had towering cliffs, and for wealth, her enormous flocks of sheep [cf. 2 Kings 3:4]; riches that were self-renewing. But the shelter of these things had bred more complacency than character."<sup>580</sup>
- 48:9 Moab needed wings since her people were bound to fly away into captivity and her cities would remain desolate. Another translation sees Moab sown with salt, a symbol of destruction in the ancient Near East (cf. Judg. 9:45), either to destroy Moab or to prepare it for the conqueror's occupation. Salt was an abundant material in Moab, which lay just east of the Dead (Salt) Sea.
- 48:10 The Lord uttered a curse on any of the soldiers that would not carry out His will against Moab as He had ordered. Christians often use this verse, appropriately, as a challenge to serve the Lord diligently. The last word in the AV rendering is "slackness."

The emphasis in the next section of the oracle is on the end of Moab's complacency (vv. 11-17).

- 48:11 The Lord compared Moab to a spoiled child and to wine that had not been poured from one container to another to remove its sediment.<sup>581</sup> Moab was famous for its wine production (cf. vv. 32-33; Isa. 16:8-11). Its peaceful

---

<sup>580</sup>Kidner, p. 142.

<sup>581</sup>Dyer, "Jeremiah," p. 1195, wrote a concise description of the whole wine-making process.

history had made Moab complacent. It was so isolated geographically that it had not experienced the discipline of frequent invasions and captivity. God sometimes sends trouble to strengthen people.

"Readers of the missionary classic, *Hudson Taylor in Early Years*, may remember the apt heading, 'Emptied from Vessel to Vessel', to a chapter describing an unsettled but ultimately fruitful few months in the missionary's second year in China."<sup>582</sup>

- 48:12-13      However the days would come when the Lord would upset Moab's complacency. He would send judgment pictured in terms of foreign "tilters" who would decant her wine, prepare it for distribution, and destroy its casks. Then Moab would be disillusioned with Chemosh for not protecting her even as Israel had been ashamed of the idols she had worshipped at Bethel.
- 48:14-15      Moab would not be able to boast about her mighty warriors in that day because others would overcome them, slay her young men, and destroy the nation. The sovereign King, Yahweh of hosts, made this promise (cf. 46:18).
- 48:16-17      Moab's destruction would come soon, so all her neighbor nations should mourn her destruction (cf. Deut. 32:35). They should bewail the fall of such a strong and splendid rule.
- Jeremiah next focused attention on the catastrophe coming on Moab's cities (vv. 18-28).
- 48:18          The prophet called the residents of Dibon to humble themselves because the destroyer would ruin their strongholds.<sup>583</sup>
- 48:19-20      Jeremiah appealed to the inhabitants of Aroer to inquire from fleeing residents what had happened. The answer was that Moab had fallen and was, therefore, humiliated. The news would go out in the Arnon Valley, Moab's northern border. Aroer stood southeast of Dibon on the southern boundary of the old Amorite kingdom, which was the Arnon River (Judg. 11:18-19).
- 48:21-24      Jeremiah listed 11 other cities of Moab that would experience destruction representing all the towns in the nation.
- 48:25          Moab would lose its strength, as when an animal lost its horn or when a person broke his arm.

---

<sup>582</sup>Kidner, p. 142.

<sup>583</sup>Archaeologists discovered the Moabite Stone at Dibon in 1868.



- 48:26 The nation would also become an object of ridicule, like a drunkard who wallows in his own vomit, because it became arrogant toward Yahweh. Implicit here is the idea of Moab drinking from the cup of Yahweh's wrath that produces drunkenness, staggering, insanity, and vomiting (cf. 25:15-29; 49:12-13; 51:6-10, 39, 57; Isa. 51:17-23; et al.). The nation had not humbled itself under Yahweh's sovereign authority, and now judgment would come.
- 48:27 Moab would become just as much a laughingstock to other nations as Israel had been to Moab when the Assyrians destroyed the Northern Kingdom. The Moabites had held the Israelites in contempt ever since that defeat.
- 48:28 The Moabites would head for the hills and hide in the caves in view of the coming destruction of their cities. They would try to hide anywhere.
- "The reputed silliness of the dove with its rickety nests is proverbial."<sup>584</sup>
- Moab's pride would finally come to an end (vv. 29-39).
- 48:29 The sins of Moab were well-known: haughtiness, pride, arrogance, and self-exaltation.
- "The sin of pride is one of the principal reasons for Moab's downfall. Had she boasted in the righteous deeds of the Lord (cf. Pss. 20:7; 34:2; Je. 9:24) she would have prospered. The Christian must avoid all false pride (cf. Mk. 7:22; Rom. 1:30; Jas. 3:5, etc.), and must boast instead in God's redemptive work in Christ (I Cor. 1:29f.; Gal. 6:14, etc.), since every human boast has been destroyed in Him (I Cor. 1:25-30)."<sup>585</sup>
- 48:30 Moab's arrogant anger and baseless boasts would not save her from just judgment.
- 48:31-33 The prophet would mourn over Moab's fate and for the fate of her people even more than people had wept over the fate of the fall of the town of Jazar. The Israelites had taken Jazar, a town 10 miles north of Heshbon, during their conquest of Transjordan (cf. Num. 21:32). Apparently the mourning over that destruction, or a subsequent one, had become proverbial. Moab was famous for its vineyards and fruit trees. Jeremiah compared the destruction to come to the cutting back of Moab's renowned products and its resulting sadness. The shouting would not be the glad

---

<sup>584</sup>Smothers, p. 317.

<sup>585</sup>Harrison, *Jeremiah and . . .*, p. 176.

rejoicing of treaders of grapes but the cries of warriors bent on destruction. Moab's tendrils stretching across the (Mediterranean) sea pictures her international trade in wine.<sup>586</sup>

- 48:34 The Moabites in Heshbon, Elealeh, and Jahaz would mourn her destruction, as would those in Zoar, Horonaim, and Eglath-shelishiyah. Even the waters near Nimrim, evidently one of Moab's more popular sites, would become desolate.
- 48:35 Yahweh promised to destroy Moab because of her idolatry.
- 48:36 Jeremiah continued to mourn over Moab's destruction. His mourning was like the sound of flute players in that it too sounded like wailing. The abundance of Moab's lost produce was good reason to sorrow.
- 48:37-38 When the nation fell there would be people expressing their grief in traditional ways everywhere. They would shave their heads, cut their beards short, cut their hands, and wear sackcloth around their hips (cf. 4:8; 16:6; 41:5; 1 Kings 18:28; Amos 8:10; Mic. 1:16). People would be lamenting on their housetops and in the streets, everywhere. Yahweh would destroy Moab as a person smashed an earthenware vessel that he or she no longer desired.
- 48:39 The nation would suffer defeat, the people would lament, the inhabitants would repent out of shame, and the kingdom would become an object of ridicule and a fearful prospect for onlookers.

The final section of the oracle stresses the full end of Moab (vv. 40-47)

- 48:40 Yahweh affirmed that like a swift eagle (or vulture) Moab's destroyer would descend on her. This was a fit figure for Nebuchadnezzar (cf. 49:22; Deut. 28:49).
- 48:41 The hearts of even mighty men in the nation would fail, like the heart of a woman in labor, at the news that Kerieth, one of the strongest of Moab's cities, and other strongholds, had fallen.
- 48:42 Moab would cease to exist as a nation because it had been arrogant toward Yahweh; it had not humbled itself under the sovereign Lord of all nations.
- 48:43-44 Escape would be unavoidable. If a person escaped one form of judgment, another one would get him. The Lord's devices would trap the people just as certainly as hunters used terror, pits, and snares to capture animals.<sup>587</sup> This would happen at the Lord's appointed time.

---

<sup>586</sup>Smothers, pp. 318-19.

<sup>587</sup>The three snares all begin with the same letters in Hebrew, forming a triple assonance.

- 48:45 Fugitives of the invasion would huddle weak in the shadow of Heshbon, the ancient capital of Sihon, king of the Amorites, because of the devastation planned and executed from there (cf. v. 2). The invasion would rob Moab and its complacent revelers of their glory, as when fire burns someone's hair off.
- 48:46 Moab would experience woe. The people of Moab, their god Chemosh's people, would perish, and their children would go into captivity (cf. Num. 21:28-29; 24:17).
- 48:47 Yet Yahweh promised to restore the fortunes of Moab in the distant future (cf. 46:26; 49:6, 39). This happened after the Exile, and it will happen in the eschaton when modern residents of Moab's territory will stream to Jerusalem to worship Messiah in the Millennium.<sup>588</sup>

The reasons for Moab's judgment were not its treatment of Israel or Judah but hubris (overweening pride) against Yahweh (vv. 26, 42), complacency (vv. 11-12), and self-sufficiency (vv. 14, 29-30). She had not bowed in submission to the Lord of all the earth.

The fulfillment of this prophecy evidently came when Nebuchadnezzar returned to Canaan in 581 B.C. to quell a rebellion by Moab and Ammon. He also took more Judahites back to Babylon with him when he returned home (52:30).

"The Moabites were conquered by Nebuchadnezzar and disappeared as a nation."<sup>589</sup>

#### **D. THE ORACLE AGAINST AMMON 49:1-6**

The Ammonites lived north of the Moabites, north of the Arnon River for most of their history, and east of the tribal territories of Gad and Reuben. However, the Ammonites had taken over some Israelite territory in Transjordan, and their borders to the north and south also changed from time to time. Ammon extended north to the Jabbok River and east to the Arabian Desert. The Ammonites, like the Moabites, descended from Lot, Abraham's nephew, and Israel's relations with both nations were normally unfriendly.<sup>590</sup>

- 49:1 The Lord asked why Malcam (lit. their king; Milcom or Molech, cf. 19:5; Deut. 12:31), the god of the Ammonites, had (from the Ammonites' viewpoint) taken over territory that formerly belonged to the tribe of Gad. Was it that there were no descendants of the Gadites to maintain control of it? No, they had not gained it by default but by stealing it from the Israelites. The Assyrians under Tiglath-Pileser III had removed the

<sup>588</sup>Feinberg, "Jeremiah," p. 663; Dyer, "Jeremiah," p. 1197.

<sup>589</sup>Feinberg, "Jeremiah," p. 656.

<sup>590</sup>See Thompson, p. 715, for more history of the Ammonites. He also wrote good summary histories of the other people-groups mentioned in this chapter.

Israelites from Transjordan in 734 B.C., and the Ammonites had moved into their territory then.

- 49:2 Because Ammon had taken over territory that Yahweh had given to His people, the Lord would send soldiers against the capital city, Rabbah (modern Amman, the capital of Jordan). He would destroy it and the other Ammonite towns and enable Israel to repossess what the Lord had given her.
- 49:3 The Ammonites in chief cities would mourn over the destruction of their other towns. Heshbon was normally a Moabite city, but at certain periods the Ammonites occupied it. This Ai must have been an Ammonite town; it could not be the Ai near Bethel in Cisjordan. The enemy would take images of Malcam into captivity along with the idol's priests and the princes of the nation (cf. 46:25; 48:7).<sup>591</sup>
- 49:4 Ammon's sins were her boasting over her natural resources (cf. 48:26, 29, 42), her material treasures that she had accumulated (cf. 48:7; 1 Tim. 6:17), and her security (cf. 48:11). Steep valleys surrounded remote Ammon on three sides. The people of Ammon, personified as a daughter, were slipping away from their secure position, as the water in their valleys flowed away.
- 49:5 Yahweh promised to terrorize the Ammonites with enemies that would attack from all directions (cf. v. 29; 6:25; 20:3-4, 10; 46:5). No one would be able to organize the fugitives because the scattering would be so great.
- 49:6 Later, however, Yahweh would restore the fortunes of the Ammonites. This occurred briefly after the Exile. Tobiah was a Persian governor of Ammon during the postexilic period (cf. Neh. 2:10, 19; 4:7). But restoration of this region will also take place in the Millennium (cf. 46:26-28; 48:47).

Nebuchadnezzar brought the Ammonites under his authority when he advanced into Palestine in 605 B.C. After that Ammon proved disloyal to Babylon in 594 B.C. (27:3) and in 589 B.C. (Ezek. 21:18-32). King Baalis of Ammon had some part in the assassination of Gedaliah (40:13—41:15). Because of these acts of unfaithfulness Nebuchadnezzar invaded Ammon, as well as Moab and Judah, in 581 B.C.<sup>592</sup> This weakened Ammon so much that Arab tribes were able to destroy her, along with Moab and Edom. By the middle of the sixth century B.C. Ammon had ceased to exist as an independent nation.

---

<sup>591</sup>If we should translate "Malcam," the meaning becomes: the enemy would take "their king" into captivity along with his priests and princes.

<sup>592</sup>Josephus, 10:9:7.

Some reasons for Yahweh's judgment on Ammon were her military aggression (v. 1) and her proud trust in her geographical situation and her treasures (v. 4).

### **E. THE ORACLE AGAINST EDMON 49:7-22**

The Edomites lived to the southeast of Judah, south of Moab. The Zered River was their northern border, the Gulf of Aqabah (about 100 miles to the south) the southern, the Arabah the western, and the desert the eastern borders. The Edomites were descendants of Esau, and a long history of antagonism with the Israelites that reached back to the days of Jacob and Esau and Israel's wilderness wanderings marked their relationship (cf. Num. 20:14-21; Judg. 11:17).

- 49:7 Teman (lit. south), a town in Edom about halfway between the Dead Sea and the Gulf of Aqabah, was famous for the wisdom of its inhabitants (cf. Job. 2:11; Obad. 8).<sup>593</sup> Yet the Edomites had not behaved wisely. The name of this town was a poetic equivalent for the whole nation (cf. Hab. 3:3), and it came from one of Esau's grandsons (Gen. 36:11).
- 49:8 The people would have to flee because the Lord was going to bring disaster on them. The oasis of Dedan lay in Edom's southeast region close to the Arabian Desert.
- 49:9-10 Grape pickers and thieves normally left some things behind, but Yahweh would leave no Edomites untouched by the judgment He would bring on this nation. He would remove every covering that protected all the people (cf. Obad. 5-6).
- 49:11 Yahweh, or perhaps a kindly survivor, promised to care for the widows and orphans left behind during the devastation of the nation.
- 49:12-13 The Edomites, who formerly had escaped divine judgment, would certainly experience the wrath of God. Bozrah, the capital and chief city in northern Edom, would become a horrible ruin and an embarrassment to the Edomites for their failure to save it, as would all the towns in the nation. People would say, "May you become like Bozrah," when they cursed others.
- 49:14-15 Jeremiah had heard a message that Yahweh had sent out by messenger to the nations ordering them to prepare for battle against Edom. Yahweh would humiliate Edom among the nations and make her an object of contempt.
- 49:16 Edom had deceived herself by thinking that other nations would be too afraid of her apparently impregnable location to attack her. But the Lord promised to bring her down and to humble her arrogance (cf. Obad. 1-4).

---

<sup>593</sup>Thompson, p. 721.

"The rock" is a translation of Sela, the site of the city carved out of rock near Bozrah, later called Petra.

- 49:17-18 Observers would be horrified at Edom's fate, which would be destruction as complete as that of Sodom, Gomorrah, and the other cities of the plain (Gen. 19). People would no longer live in Edom.
- 49:19 Yahweh promised to invade Edom as a lion attacks a flock of sheep, a phenomenon well-known in Edom. Lions repeatedly ventured out of the dense jungle foliage in the Arabah to attack sheep grazing on the pastures of that valley. Edom's shepherd leaders would not be able to resist the Lord but would run away (cf. 50:44-46). Then Yahweh would appoint over the nation whom He chose, and no one would be able to challenge or overturn His sovereign authority.
- 49:20-21 God's purposes for Edom were to have enemies drag all the people from their country, even the children, leaving the land desolate of people. News of Edom's destruction would spread far and have major repercussions. Even Egypt would hear of it since the news would cross the Red Sea.
- 49:22 The enemy would come down on Edom like an eagle (or vulture, cf. 48:40-41). Men would be as fearful as women in labor when the invader struck.

Nebuchadnezzar fulfilled the judgment predicted in this prophecy when he subdued the entire Transjordan region. Like Moab and Ammon, Edom plotted against the Babylonians who had incorporated them into their empire about 605 B.C. However, the Edomites assisted the Babylonians in attacking Judah in 588-586 B.C. (Ps. 137:7; Lam. 4:21; Ezek. 25:12-14; Obad.). Babylonian reprisals against Edom for lack of cooperation, and subsequent invasions of Arab tribes (Nabateans; cf. Mal. 1:1-4), drove the Edomites into Judah where they settled north of Hebron. This area later became known as Idumea. Herod the Great was an Idumean.

Misplaced trust in herself and in her reputedly inaccessible heights caused Yahweh to judge this nation (v. 16).

#### **F. THE ORACLE AGAINST DAMASCUS 49:23-27**

Perhaps this oracle is shorter because Damascus had not had the history of contact with Judah in recent years that the other nations mentioned in these oracles did. However the books of Samuel, Kings, and Chronicles document incessant hostilities between the Arameans and Israel and Judah earlier in history. Damascus was the capital of Aramea and the leader of a coalition of Aramean city-states (cf. Isa. 7:8). It stood about 150 miles north-northeast of Jerusalem.

- 49:23 Hamath, 110 miles north of Damascus, and Arpad, 95 miles north of Hamath, were allied city-states that would hear disheartening and shameful news. The sea may have been some local body of water or some

local symbol that Jeremiah used as a figure of disquietude.<sup>594</sup> The lovely Pharpar River flowed through the city (cf. 2 Kings 5:12).

- 49:24 The bad news was that Damascus had panicked and fled before an enemy. She would behave like a woman in childbirth, namely, fearfully and helplessly.
- 49:25 Yahweh announced that the town that had brought joy to Him and that others praised for its beauty and leadership had become deserted. Damascus was considered to be one of the most beautiful cities of ancient times.<sup>595</sup> Even today many visitors to Damascus comment on its unusual beauty.
- 49:26-27 When Yahweh destroyed the city all her young soldiers would perish and it would burn down (cf. Amos 1:4), even the fortified towers named in honor of a number of great Aramean kings named Ben-hadad (lit. son of [the god] Hadad).<sup>596</sup>

Jeremiah indicated no reason for Yahweh's destruction of Damascus. One of the major reasons for divine judgment on all the nations and groups mentioned in these oracles, though not stated here, was their hostility to the seed of Abraham. God had promised to curse those who cursed Israel (Gen. 12:3), and every one of these oracles assured the fulfillment of that promise. Judging Israel's enemies was part of covenant faithfulness for the suzerain of all the earth.

### **G. THE ORACLE AGAINST THE ARAB TRIBES 49:28-33**

As with the previous oracle, the length of this one reflects the relative importance to Judah of those cursed by God. These Arab tribes were some of the descendants of Ishmael, Isaac's half-brother (Gen. 25:12-18). Again, antagonism marked their history with Israel.

- 49:28 Nebuchadnezzar also defeated Kedar, a prominent Arab tribe (2:10; Gen. 25:13; Isa. 21:16-17; 42:11; 60:7; Ezek. 27:21; et al.) and the tribes around Hazor, a place in the eastern desert (not the town in northern Galilee). The past tense in this title verse may have been added after Nebuchadnezzar's invasion, but the oracle is a promise of future destruction. Or this may be a Hebrew prophetic perfect in which the prophet spoke of the future as past because it was certain to happen. Yahweh ordered the Babylonian king to devastate these eastern Arabs (cf. Judg. 6:3).
- 49:29 These nomads would gather up their tents and other possessions and would flee before the advancing Babylonian soldiers. Their cry of "terror on every side" was one of Jeremiah's stock expressions (cf. v. 5; et al.).

<sup>594</sup>Feinberg, "Jeremiah," p. 669.

<sup>595</sup>Graybill, p. 690.

<sup>596</sup>Hadad was an Aramean storm god, the equivalent of the Canaanite Baal.

- 49:30 Yahweh encouraged them to flee and to hide in any recesses they could find because Nebuchadnezzar had a plan to wipe them out.
- 49:31 The Lord instructed Nebuchadnezzar to go against these nomads that lived at ease and securely in the desert by themselves rather than in walled cities.
- "Carefree living was frowned upon in Old Testament times, since even the most heavily fortified location could be overthrown. The life of the Christian, who has been bought with a price (I Cor. 6:20; 7:23), must be spent in the service of God and man, not in selfish indulgence."<sup>597</sup>
- 49:32 Their camels and cattle would become booty for the Babylonians who would be the Lord's instrument in scattering and destroying the Arabs. One of their distinguishing features was that they rounded off the corners of their beards. Those who lived in the open air would scatter to the winds.
- 49:33 Hazor would become a desolate haunt of wild animals rather than a center for these Arab tribes.

Nebuchadnezzar raided these Arab tribes in 599 B.C., the year before he began his invasion of Palestine.<sup>598</sup>

Again the major reason for judgment, though not stated in the oracle, must be Yahweh's covenant faithfulness to His promise to punish those who were enemies of the Israelites (Gen. 12:3). They also violated the Noahic Covenant in which God decreed, "Whoever sheds man's blood [without divine authorization], by man his blood shall be shed" (Gen. 9:6).

#### **H. THE ORACLE AGAINST ELAM 49:34-39**

Elam was the land of the Elamites who lived somewhat east of the Babylonians (in modern southwest Iran). We know little about the history of the Elamites, and their inclusion in a collection of judgments against Israel's hostile neighbors comes as a surprise. The oracle is noteworthy for its strong statements of threat and judgment.

"In contrast to the other oracles concerning the nations in Jeremiah, human agency recedes drastically. The sovereignty of the LORD over the affairs of all nations is accented by the announcement that the LORD would place his throne in Elam and destroy its gods (king and princes)."<sup>599</sup>

---

<sup>597</sup>Harrison, *Jeremiah and . . .*, p. 182.

<sup>598</sup>Wiseman, pp. 31-32, 71.

<sup>599</sup>Smother's, p. 342.



- 49:34 This oracle came to Jeremiah at the beginning of King Zedekiah's reign, about 597 B.C. By this time it had become clear that the invader from the north would be Babylon.
- 49:35 Yahweh announced that He would break Elam's military might, like someone would break a warrior's bow. The Elamites were famous archers (Isa. 22:6).
- 49:36-37 God would scatter the Elamites in every direction using military attacks from many different directions to do so (cf. Ezek. 37:9; Dan. 8:8; Zech. 6:1-8). He would destroy them in battle.
- 49:38 Yahweh would establish His sovereignty over Elam and would destroy its ruling dynasty.
- 49:39 In the last days, however, the eschatological future, He would restore Elam's fortunes (cf. v. 6; 48:47). People from this area will experience Yahweh's blessing in the Millennium. Elam became a satrapy of the Persian Empire, and its capital, Susa, became the winter residence of the Persian kings after 539 B.C.<sup>600</sup> But this promise projects beyond that time.<sup>601</sup>

Why did God announce judgment on a people that were so geographically remote from Judah in this collection of oracles? There may have been more hostility in Elamite Israelite relations than history has revealed so far. However, the attack by one Elamite king on Abraham and his family (Gen. 14) may have been adequate reason for God's punishment (Gen. 12:3). Probably there was continuing hostility. Moreover, since the Elamites were ancient allies of the Babylonians, they had to share the guilt of Babylon's sins against God's people (cf. Gen. 9:6).

A promise of restoration does not appear in every oracle. Nevertheless, we should probably understand that as God judged all these nations, so He will also bless the people who will be living in these territories when Christ returns to set up His kingdom on earth.

Another difference between the oracles is that some mention the reasons for judgment but others do not. Probably the reasons for God's judgment of them all are the same, namely, failure to acknowledge His sovereignty and to live humbly by recognizing Him as the God of all the earth. He was their suzerain and they were His vassals. Other reasons were their antagonism toward His people and their brutality toward others.

"The oracles provide data that suggest that they were viewed in a treaty context. First, the oracles contain judgment statements that are similar to the curses characteristic of international treaties . . . Second, the cup-of-wrath concept may reflect the treaty and the manner in which it was

<sup>600</sup>Thompson, p. 729; Harrison, *Jeremiah and . . .*, p. 147..

<sup>601</sup>Feinberg, "Jeremiah," p. 671.

imposed . . . Third, there are references to military aggression against fellow vassals that point to treaty violations (48:1-2, 45; 49:1-2).

"The conclusion reached is that the OAN [oracles against nations] in Jer 47—49 reflect the context of the international treaty, providing the prophet a metaphor for expressing his understanding of the relationship of the LORD to the nations. The oracles, whether or not they were all intended to be heard by the nations, served first of all to affirm the sovereignty of the LORD over all the world, and second, they served as a warning to Judah, to refrain from trusting in alliances with, or in dependence upon, nations that stood under divine judgment."<sup>602</sup>

"In recent history, the nations haven't acted any better than the ones recorded in Jeremiah 46—49. Innocent blood is shed legally as millions of babies are aborted in their mother's wombs. International terrorism, genocide, exploitation of people and material resources, war, crime, the abuse of children, and a host of other sins have stained the hands of nations with blood. What will they do when the Judge becomes angry and starts to avenge the innocent?"<sup>603</sup>

### **I. THE ORACLE AGAINST BABYLON CHS. 50—51**

Jeremiah wrote almost as much about Babylon's future as he did about the futures of all the other nations in his other oracles combined. The length of this oracle reflects the great importance of Babylon in his ministry as well as in the ancient Near East in his day.

"Fittingly, the empire which struck the most devastating blow ever suffered by the kingdom of David, receives the longest series of oracles about her own future."<sup>604</sup>

The 110 verses in these two chapters undoubtedly consist of several different messages that the prophet received from the Lord at various times, which the writer brought together in this collection. Two themes predominate: the judgment coming on Babylon, and the restoration of Israel and Judah to their homeland. The oracular material appears in three types of rhetorical statements: those dealing with war against Babylon, Israel's departure from Babylon, and historical reminiscences.<sup>605</sup>

The oracle begins with an overview of what Yahweh would do to Babylon and Israel in the future (vv. 1-10). Much of the prophecy in this section has not yet been fulfilled.

---

<sup>602</sup>Smothers, p. 277.

<sup>603</sup>Wiersbe, p. 139. Cf. Heb. 10:31.

<sup>604</sup>Kidner, p. 148.

<sup>605</sup>See M. Kessler, "Rhetoric in Jeremiah 50 and 51," *Semitics* 3 (1973):3-32.

- 50:1 This is a title verse for the oracle against Babylon, the land of the Chaldeans.<sup>606</sup> The Chaldeans were the descendants of a semi-nomadic tribe that had settled south of Ur in Mesopotamia in the third millennium B.C. Nebuchadnezzar's father, Nabopolassar, the founder of the Neo-Babylonian Empire (626-539 B.C.), was a native Chaldean. Nebuchadnezzar was the most illustrious and longest reigning of these Chaldean kings.
- 50:2 The Lord commanded announcing among the nations that Babylon would be captured. Her chief idols, Bel and Marduk, as well as all her gods, would be humiliated since it was their job to protect Babylon.<sup>607</sup> Bel was the title of the storm god Enlil, the chief god of Nippur.<sup>608</sup> Marduk (Merodach) was the creator god who emerged as Babylon's chief deity and the head of the pantheon of Babylonian idols. Jeremiah used Bel and Marduk in this verse to represent all the Babylonia gods. He referred to their images as pieces of human excrement (Heb. *gilluleyha*, "her idols"; cf. Lev. 26:30; Deut. 29:17; 1 Kings 15:12; 21:26; et al.).<sup>609</sup>
- 50:3 An invader would descend on Babylon from the north and would make her an object of astonishment. All of Babylon's inhabitants, humans and animals, would leave her. Elsewhere in Jeremiah the enemy from the north is Babylon, but in the future, ironically, the invader of Babylon would come from the north.

"The reference at this stage is hardly to the Persians who came from the east, although the strategic line of attack was roughly from the north."<sup>610</sup>

Neither was the land, or even the city, totally uninhabited after the Persians took over. People did not flee because of the Persians. For example, Daniel, who had access to Jeremiah's prophecies (Dan. 9:1-2), remained in the capital city during and after its fall (Dan. 5:28, 30-31; 6:1-3).

"Several times Jeremiah repeated this fact about Babylon being without any inhabitants (cf. vv. 39b-40; 51:29, 37, 43, 62). The city was spared and made one of the ruling

---

<sup>606</sup>Normally "Babylon" refers to the nation rather than the city, as this verse makes clear. Some expositors have applied almost all the prophecies to the city rather than to the whole nation. Probably both entities are in view, the city sometimes and the country sometimes.

<sup>607</sup>See John D. W. Watts, "Babylonian Idolatry in the Prophets As a False Socio-Economic System," in *Israel's Apostasy and Restoration: Essays in Honor of Roland K. Harrison*, pp. 118-20.

<sup>608</sup>He was the equivalent of Baal in Canaan and Hadad in Aramea. The Babylonians also called Marduk Bel. Smothers, p. 365.

<sup>609</sup>Ezekiel used this Hebrew word to describe idols no less than 38 times.

<sup>610</sup>Thompson, p. 733.

centers for the Persian Empire with Daniel serving there in an administrative position (cf. Dan. 5:30; 6:1-3)."<sup>611</sup>

Alexander the Great destroyed Babylon in 330 B.C., but that destruction was not from the north or final either.

50:4 At the time of Babylon's destruction the Israelites would leave her, both Israelites and Judahites. They would go out weeping as they left and seeking Yahweh their God. This weeping probably anticipates Israel's national repentance at the second coming of Christ (cf. Zech. 12:10-14). Judah and Israel did not unite as one nation after the Persians took over, and most of the exiles did not return to the Promised Land.

"The phrase, *In those days* (4), is nearly always a pointer to the messianic age to come."<sup>612</sup>

50:5 The Israelites would seek direction to return to Zion. They would go there to make an everlasting covenant with Yahweh, one that they would not forget as they had their former (Mosaic) covenant. This is a reference to the New Covenant (31:31-33; 32:40). Israel has not yet experienced the changes that the New Covenant promised (e.g., 32:40). She did not enter into this covenant with God after Babylon fell to the Persians.

50:6 The Lord's chosen people had gotten lost like sheep misled by their shepherds. They had wandered on dangerous mountains instead of staying in their safe places of rest. This verse reflects conditions that marked the Israelites long after Cyrus permitted them to return to Palestine. They are still scattered around the world.

50:7 Enemies had devoured these "sheep," but had rationalized their sin by saying that the Israelites deserved what they got because they had sinned against their God. Yahweh was a dwelling place for Israel marked by righteousness and the hope of their forefathers. These conditions describe Israel's present plight as well as her state during the Babylonian captivity.

50:8 The Lord encouraged His people to leave Babylon, the land of the Chaldeans. They should step out like rams to lead the rest of the flock. People other than Israelites left Babylon after it fell, but this prediction probably points primarily to Israel's leadership of other nations to Messiah in the future.

50:9-10 Yahweh promised to become active again for His people and to bring many great nations from the north against Babylon. After a battle, Babylon would fall. The enemy would be skillful in archery and would

---

<sup>611</sup>Dyer, "Jeremiah," p. 1199.

<sup>612</sup>Kidner, p. 149.

take many captives. The enemy would take so much plunder that he would be satisfied. The references to many nations and the north point to a future fulfillment as well as to a partial past fulfillment.

The next prophecies focus on the fall of Babylon (vv. 11-16).

50:11 Babylon had rejoiced gleefully when she plundered Yahweh's heritage, behaving like a young heifer at threshing time or like a lusty stallion. In ancient Israel a man's heritage (Heb. *nahala*) was the land he inherited from his ancestors. Jeremiah pictured the land of Israel as Yahweh's heritage (cf. 2:7; 16:18).

50:12-13 Mother Babylon would be humbled when God would make her the least of the nations. She would be like a desert compared to a fertile field. The Lord would remove her inhabitants and make her completely desolate. Observers would marvel and whistle at the horrible condition of the once proud Babylon.

"Cyrus did not destroy [the city of] Babylon when he captured it. Later in the Persian period the city revolted, and Darius Hystaspes captured it and destroyed its walls (514 B.C.), thus beginning its decay. The city continued to decline until well into the Christian era, when it ceased to exist. The desolate ruins remained for archaeologists to uncover in the nineteenth century."<sup>613</sup>

50:14-15 Yahweh called Babylon's enemies to attack her with all their strength because she had sinned against Him. The destruction should continue until the land was thoroughly ruined. She had destroyed other nations, and now she deserved the same treatment. The clause "she has given her hand" may be treaty terminology (cf. 2 Kings 10:15; Ezek. 17:11-21).

"What is clearly in view here is treaty violation by concluding a treaty with another party."<sup>614</sup>

50:16 The agricultural cycle would end, from sowing to reaping, because of the fighting of Babylon's enemy. The enemy soldiers would return to their own lands when they finished their job.

"Cyrus, who unified the Medo-Persian Empire and then overwhelmed Babylon (ZPEB, 1:1054-56), was careful to spare the country; so the reference (v. 16) must be to a later attack."<sup>615</sup>

---

<sup>613</sup>Graybill, p. 691.

<sup>614</sup>Smothers, p. 366.

<sup>615</sup>Feinberg, "Jeremiah," p. 674. ZPEB stands for the *Zondervan Pictorial Encyclopedia of the Bible*.

The next section of the oracles emphasizes the restoration of Israel (vv. 17-20).

50:17 The king of Assyria, Sennacherib, had scattered the Israelites in the Northern Kingdom like sheep (in 722 B.C.; 2 Kings 17:1-6; Isa. 5:29), and the king of Babylon, Nebuchadnezzar, had done worse to the Judahites in the south (in 605-581 B.C.; 4:7; 2 Kings 24). He had broken their bones—not just scattered the people but also slain them.

"Politically, the intrigues and treacheries of Judah's kings ('shepherds', as the Old Testament regards them) had brought Assyria and now Babylon to the kill. Spiritually too (to adopt the New Testament connotation of 'shepherd'), a badly pastored flock is soon astray, then swiftly preyed upon."<sup>616</sup>

50:18 Because of this treatment Yahweh of armies, Israel's God, promised to punish Babylon as He had punished Assyria. Assyria had fallen to the Babylonians in 612-609 B.C., and now it was Babylon's turn to fall.

50:19 The Lord would bring His sheep back to pasture in their own land. They would enjoy peace and plenty in the best portions of the western and eastern portions of Israel.

50:20 When the Lord would do this, all the remaining remnant of His people would be free from sin; no one would be able to find any sin in them even though they searched carefully for it. The reason for the absence of their sin would be that Yahweh had pardoned it. Yahweh's pardon of the nation lies in the future (31:34).

"All this [i.e., the things predicted in vv. 17-20] will be realized in messianic times, as v. 20 declares."<sup>617</sup>

The following prophecies describe further the divine vengeance coming on Babylon (vv. 21-28).

50:21 The Lord commanded Babylon's destroyers to go up against the land of double rebellion, the meaning of "Merathaim." Assyria and Babylon both came from the same general area, Mesopotamia, and both nations had rebelled against Him. He gave their land the name Pekod, meaning "punishment." Divine punishment would mark Mesopotamia. The destroyer should carry out the Lord's directions exactly by slaying and completely destroying the Babylonians. The Persians did not do this.

---

<sup>616</sup>Kidner, p. 150.

<sup>617</sup>Feinberg, "Jeremiah," p. 675. Harrison, *Jeremiah and . . .*, p. 185, agreed.

Merathaim (*Mat Marratim*) was a region at the head of the Persian Gulf where the Tigris and Euphrates Rivers met. Pekod was a region, named after a tribe, in southeastern Babylonia (cf. Ezek. 23:23). Jeremiah made a play on these names to affirm the rebelliousness and certain judgment coming on Babylon.

50:22-23 The sounds of battle and great destruction would fill Babylonia. The nation that had been Yahweh's hammer to smash so many other nations would be broken itself. It would become an object of horror in the earth.

50:24 The Lord described Babylon as a wild animal caught in a trap and as a thief caught unaware because she had conflicted with Him. Previously Babylon had ensnared other nations.

"The point is made elsewhere in the prophets that Yahweh may appoint a nation to fulfil [*sic*] a purpose as his servant. But this does not absolve such a nation from the consequence of guilty acts or an insolent attitude [cf. Isa. 10:5-19; Hab. 2]."<sup>618</sup>

50:25-26 God would bring out His heavy artillery against the Chaldeans because He is the sovereign Yahweh Almighty. Babylon's enemies would steal her resources, as people from afar empty out barns piled with good things, until nothing would be left.

50:27-28 The young leaders of the nation would die like bulls in a timely sacrifice. Fugitives and refugees would return to Zion from Babylon with word that Yahweh had taken revenge for the destruction of His temple.

The prophet next stressed Babylon's arrogance (vv. 29-32).

50:29 Attackers would assail Babylon with their arrows. They would surround her and allow no Chaldeans to escape. They would pay her back for all the blood she had shed because she had lifted herself up in pride against the Holy One of Israel (cf. Gen. 9:6).

50:30 Babylon's young men would die because of fighting in the streets, and her soldiers would fall silent in death (cf. 49:26).

50:31-32 Yahweh Almighty announced His antagonism against Babylon for her arrogance. She was pride personified, the epitome of arrogance. The time for her punishment had arrived. The proud Chaldeans would trip and fall—hardly a desirable action for the arrogant—and none would help them up. The Lord would burn down their cities and consume their outlying areas.

---

<sup>618</sup>Thompson, pp. 741-42.

The Lord promised Israel future redemption (vv. 33-40).

50:33-34 Presently the Israelites and Judahites were oppressed, and their captors would not let them go, but their Redeemer (Heb. *go'el*), Yahweh Almighty, was strong (cf. Exod. 6:6; 7:14; 9:2, 13; 10:3; 15:13). He would plead their case vigorously by contending with their enemy. Formerly Yahweh had brought charges against His people as a prosecutor (2:9), but in the future He would act as their defense attorney (cf. 51:36). The Lord would bring turmoil to the Babylonians so the rest of the world could enjoy rest when Babylon fell.

"The redeemer or advocate in normal life was a kinsman who took it upon himself to avenge the murder of a kinsman, to protect him, or to secure his freedom or the release of his property (cf. Lev. 25:25, 47-55; Num. 35:21; etc. [Ruth 4])."<sup>619</sup>

50:35-36 Yahweh decreed a military invasion for all the people of Babylon, from the ordinary citizens to the officials and sages. The pagan priests would prove to be fools instead of wise men, and the bravest warriors would turn out to be losers.

50:37 Their horses and chariots would suffer defeat, and Babylon's allies would be as ineffective in battle as women. Her treasures would also perish at the hands of enemy looters.

50:38 Babylon's waters would dry up too in judgment because of the idolatry that was rampant there. The city of Babylon depended on waterways for irrigation and agriculture, as the whole nation relied on the Tigris and Euphrates Rivers and their tributaries. When Cyrus captured Babylon, he may have entered under the walls, using the dry riverbed, after he diverted the Euphrates River that flowed through the city.<sup>620</sup>

50:39-40 Babylon would be inhabited only by wild animals forever, no longer by human beings. It would be as uninhabited as Sodom and Gomorrah after the Lord overthrew those cities. Babylon continued to be inhabited for many years following the Persian take-over, and the present countries of Iraq, Kuwait, and Syria currently occupy its territory. This prophecy anticipates the future destruction of Babylon (cf. Zech. 5:5-11; Rev. 16:19; 17:1—19:3).

"This prediction has not yet been fulfilled. Babylon has been inhabited throughout her history, and the government of Iraq has begun restoring some portions of the ancient

<sup>619</sup>Ibid., p. 743.

<sup>620</sup>Harrison, *Jeremiah and . . .*, p. 185. Cuneiform documents have put this account of Babylon's fall by Herodotus in question. See Edward J. Young, *The Book of Isaiah*, 3:191, for discussion.



city. Iraq's plans to restore Babylon are published in a pamphlet, *Archaeological Survival of Babylon Is a Patriotic, National, and International Duty* (Baghdad: State Organization of Antiquities and Heritage, 1982). The prophecy about Babylon's complete ruin awaits a future fulfillment during the Tribulation period."<sup>621</sup>

The next section of prophecies stresses the agony of Babylon (vv. 41-46; cf. 6:22-24; 49:18-21).

- 50:41-42      Babylon's invader would be a numerous mighty army that would descend on her from the remote parts of the north. The Persians and their allies did not come from remote regions; they were the neighbors of the Babylonians. This invader would come with bows and javelins and would fight cruelly and unmercifully. The sound of its approach would be like the roaring sea. The soldiers would ride horses and proceed against the Babylonians with discipline. Babylon would be like a young girl in comparison. Whereas Cyrus' army contained a variety of vassal contingents (cf. 51:27-28), he took the city by stealth. Thus the destruction envisioned here is probably a future one.
- 50:43      When the king of Babylon heard about the coming enemy, he would go limp with fear, like a woman about to give birth (cf. 6:22-24). Contrast the reaction of Belshazzar in Daniel 6.
- 50:44      Babylon's enemy would come out against her like a lion coming out of the Jordan Valley jungle to a nearby pasture. The Babylonians would try to flee like sheep before the lion, but the Lord's appointed agent would overpower the Chaldeans. The Lord would sovereignly control Babylon's fate, and no one would have sufficient authority to call His decisions into question. No other shepherd of people could withstand the Great Shepherd.
- 50:45      God's plan for Babylon was that an enemy would carry the Chaldeans off like a lion dragging a little lamb. Yahweh would clear the pasture of Babylon of its inhabitants.
- 50:46      When the Lord gave the command the enemy would seize Babylon. The result would be a major upheaval in the affairs of the world and a cry of surprise from the nations (cf. Rev. 18:15-19).

The next prophecies assure the judgment of Babylon (51:1-14).

- 51:1      Yahweh announced that He would arouse against Babylon and Leb-kamai the spirit of a destroyer, or a destroying wind. Leb-kamai (lit. heart of my

---

<sup>621</sup>Dyer, "Jeremiah," p. 1201.

adversaries) was a code name (atbash) for Chaldea (cf. v. 41; 25:26). Here it functions as a poetic synonym.<sup>622</sup>

- 51:2 The Lord would send foreigners to winnow the nation, as farmers tossed their grain in the air so the wind would blow the chaff away (cf. 49:32, 36). This enemy would oppose her on every hand and would devastate her land. The wind would not just blow the chaff away but would lay waste the entire land, like a devastating sirocco.
- 51:3-4 The Chaldeans need not try to defend themselves because the enemy would attack too quickly. The young Babylonian soldiers would fall in the streets of their cities. Sometimes conquerors spared the young soldiers to fight for them in the future, but the destruction of Babylon's army would be thorough.
- 51:5 The Lord Almighty had not forsaken either Israel or Judah even though they were guilty before the Holy One of Israel.
- 51:6 The Israelites should flee out of Babylon when the destruction came because the Lord would pay Chaldea back for her sins. If they did not flee, they could get caught up in the fallout of divine judgment (cf. Gen. 19:26).
- 51:7 Babylon was responsible for seducing many other nations to join her in her sins. These nations had fallen under the power of Babylon and had behaved like drunkards (cf. Rev. 18:3). She had given the cup of God's wrath to other nations, but now she would have to drink from it herself (cf. 25:15-29). A golden cup suggests the great wealth of Babylon.
- 51:8-9 The fall of Babylon would be sudden and final. The cup that was Babylon would break and be irreparable. People would lament over her demise and would wish they could revive her but would not (cf. Rev. 18:11-19). Therefore, they would abandon her to her monumental judgment (cf. Num. 13:28; Deut. 1:28).
- "What is special to this passage is the note of sadness over her incurable condition (8b-9a)—a note which chimes in with this book's description of sin as desperate sickness [cf. 46:11], and also with the many glimpses of God's reluctant resort to judgment when all else has failed."<sup>623</sup>
- 51:10 The judgment of Babylon would vindicate God's people (cf. Isa. 40:2; Rev. 19:1-3). They would call on each other to glorify God in Zion by relating His great work of judging Babylon.

---

<sup>622</sup>Another use of the atbash was to hide the identity of the nation referred to (cf. 1 Pet. 5:13).

<sup>623</sup>Kidner, p. 151.

51:11 This oracle names the Medes as God's instrument to destroy Babylon for destroying His temple. The fall of Babylon to the Medes was a fulfillment of this prophecy, but it did not fulfill all the prophecies about the fall of Babylon in these chapters. The Medes lived north of Babylon (in northwest Iran, Iranian Kurdistan). The Medes had been allies of the Babylonians in the destruction of Nineveh, the capital of the Assyrian Empire, in 612 B.C. Later they joined with the Persians to defeat Babylon in 539 B.C. (cf. Dan. 5:28, 31; 8:20).

"In 550 B.C. Cyrus the Persian ruler invaded the region [Babylon] and subjugated it. . . . There is some evidence that about 561-560 B.C. an invasion of Babylon by the Medes was expected. We have no historical evidence of any outcome.<sup>624</sup> On the other hand the term Medes may be a general one. It is known that the mother of Cyrus the Persian was a Mede, and the Medes and Persians were linked together several times in the book of Daniel (e.g., Dan. 5:28; 6:8, 12, 15). In that case the reference here may be to Cyrus, but the matter is still open to debate (cf. Isa. 13:17)."<sup>625</sup>

51:12 The Medes should prepare for an attack against Babylon because the Lord would fulfill His judgment of her. Jeremiah described the attack in traditional siege terms, though when the Medes took Babylon they did not use these methods.

51:13 The end of wealthy Babylon, which stood by many waters, had come. Numerous canals and waterways provided water and irrigation for Mesopotamia. Babylon's great wealth had come to her largely from the temples and palaces of other nations that she had captured (cf. 52:12-13, 17-23; 2 Kings 24:13; 25:13-17; Dan. 5:2-4). Her end would come as when someone cut a piece of cloth from a loom, a common figure for death (cf. Isa. 38:12).

51:14 Almighty Yahweh swore by Himself, the highest authority, that He would send invaders on Babylon, as thick and devastating as a locust plague, who would shout in victory over their foe.

The next verses emphasize particularly Yahweh's sovereignty over Babylon (vv. 15-19). The last verse of this section (v. 19) identifies the person being described as Yahweh Almighty. By referring to Him in the third person in the preceding verses, the writer built anticipation for the revelation of His identity. This prophecy is almost identical to the one

---

<sup>624</sup>See Wiseman, p. 38.

<sup>625</sup>Thompson, pp. 752-53.

in 10:12-16.<sup>626</sup> There Jeremiah reminded Judah of the impotence of idols, and here he instructed Babylon about the same thing (cf. 1 Cor. 5:10; 6:9; 8:4; 10:7).

51:15 Yahweh created the earth below with His power and wisdom, and He stretched out the heavens above with His understanding. Marduk, the Babylonian creator god (50:2), did not do this. This verse describes God's past activity with regard to nature.

51:16 This verse describes His present activity. He is the one who gathers clouds together and sends rainstorms on the earth with lightning and wind. The Babylonian storm god Bel was not responsible for this (50:2).

51:17-18 Human beings are stupid for making lifeless idols that only disappoint and shame them with their inability to control nature. These idols are worthless and mock their makers with their impotence. At the designated time they will perish.

51:19 The humble and despised nation that descended from Jacob has a better resource than idols. Yahweh Almighty is the name of his God. He is the maker of everything and the God who chose Israel as His inheritance. Thus Yahweh was Israel's portion in a unique sense.

The next two prophecies further describe Yahweh's instrument for judging Babylon (vv. 20-26).

51:20-23 The Lord addressed an entity that He did not identify in these verses as His war-club or shatterer (cf. 50:23; Isa. 10:5). He would use this entity to destroy nations, armies, and people of all ages and all types.

51:24 He would use this entity to repay Babylon and all the inhabitants of Chaldea for what they had done to Zion. The Israelites would witness Babylon's judgment.

51:25 The Lord described His antagonism against Babylon, which He likened to a mountain that towered over the other nations (cf. Dan. 2:35, 44-45). He would break down Babylon, which had destroyed the whole earth, as He might burn down a mountain. It would become like an extinct volcano that had spewed out destruction but then blew itself to bits. Yahweh would do this with His own powerful hand.

51:26 God would so thoroughly destroy this "mountain" that people would not be able to use any of its stones to build. People would not be able to use the pieces of Babylon that God would destroy to build other nations. This

---

<sup>626</sup>There are many examples of doublets in Jeremiah. The prophet frequently repeated phrases, sentences, and whole passages in different contexts. Jesus did the same thing, as is clear in the Gospels.

was not the condition of Babylon after Cyrus took the city. He left it intact. Thus this must refer to a future destruction of Babylon.

Several nations would ally themselves against Babylon (vv. 27-33).

- 51:27 Jeremiah called for an assembling of nations to go to war against Babylon. The kingdoms of Ararat, Minni, and Ashkenaz—all referred to in Assyrian inscriptions—were in eastern Anatolia (modern Armenia) north of Babylon. This united armed force would descend on Babylon like an army of locusts at a very destructive stage in their lifecycle (cf. v. 14).<sup>627</sup>
- 51:28 The prophet called these nations to dedicate themselves to their task. Another nation summoned was the Medes (v. 11), which had extensive lands and armies to Babylon's northeast.
- 51:29 The land would quake at the battle that would carry out the Lord's will against Babylon, namely, to make it an uninhabited desolation.
- 51:30 The strong Babylonian warriors would become exhausted, stop fighting, and retreat to their strongholds like women.<sup>628</sup> The enemy would set their houses on fire and would break down the gates of the city.
- 51:31-32 The king of Babylon would learn from running messengers within the city that it had fallen and that the enemy had taken the fording places of the waterways and had burned the marshy areas where refugees might hide. He would hear that his soldiers were terrified.
- 51:33 Israel's sovereign God announced that though Babylon had threshed other nations in the past, her own time of threshing would come.

The prophet explained Judah's complaint against Babylon (vv. 34-40).

- 51:34-35 Jerusalem, personified, would say that Nebuchadnezzar had destroyed her. He had eaten her up, crushed her, cast her aside, swallowed her like a monster, and washed her away as with a flood. Nebuchadnezzar had done to Jerusalem what the great fish had done to Jonah. Jerusalem wished that her blood on Babylon would identify Babylon as guilty.
- 51:36 Because of what Babylon had done to Judah, the Lord promised to act as her defense attorney and to get Babylon to pay full damages. He would dry up her broad river, the Euphrates, the source of her agricultural fertility.

---

<sup>627</sup>Harrison, *Jeremiah and . . .*, p. 188.

<sup>628</sup>Women did not normally serve as soldiers in ancient times.

"The LORD's promised victory over 'her sea' and 'her fountain' recalls the LORD's victory over sea at creation and in the Exodus (Exod 15:8; Pss 74:13-14; 89:9-10; Isa 27:1)."<sup>629</sup>

- 51:37 Babylon would become nothing more than a heap of ruins that jackals would climb on, an uninhabited place that people would whistle at when they considered what had happened to the once great city.
- 51:38-39 The Babylonians would growl in anticipation of their conquest, like young lion cubs did before they ate. When the Babylonians got worked up, the Lord would serve them a banquet that would finish them off. His cup of wrath would stupefy them. It was when Belshazzar was getting himself all worked up at a banquet that Daniel announced to him that Babylon would fall that very night (Dan. 5).
- 51:40 The Babylonians, formerly lion-like (v. 38), would fall like lambs, rams, and goats to the slaughter.

Jeremiah revealed again the fate of Babylon (vv. 41-48).

- 51:41 In the future, people from all over the world would marvel that Babylon, the city praised by the whole earth, had been captured. Sheshak was another code name (atbash) for Babylon evidently used here for poetic variation (cf. 25:26).
- 51:42 It would be as though the waves of the sea had overwhelmed Babylon.
- "There is probably an allusion here to the mythological chaotic waters of the primeval ocean (Tiamat) which, according to the Babylonian myth of creation, were overthrown by the god Marduk when he fought against Tiamat and destroyed her. The fall of Babylon would be of such gigantic proportions that it would appear as nothing less than a reversal of that primeval victory."<sup>630</sup>
- 51:43 All the cities of the land would become uninhabited, and the land would become a waterless desert. No one would even pass through the land.
- 51:44 Yahweh would humiliate Bel (lit. lord; cf. 50:2), the representative god of Babylon. The nation, personified as Bel, would regurgitate or give back what it had taken from other nations (cf. v. 34). Nations would no longer

---

<sup>629</sup>Smothers, p. 371.

<sup>630</sup>Thompson, p. 764. See also Smothers, p. 371; Harrison, *Jeremiah and . . .*, p. 187.

seek Babylon out because it would become weak and vulnerable to attack. Even her walls, which enclosed an area of 200 miles, would fall down.<sup>631</sup>

"The city wall proper was of double construction. The outer component was 12 feet thick, so that is [*sic*] was wide enough to allow several chariots to drive abreast along the walls. Towers were set into the walls at intervals of about 60 feet. Outside the walls lay a ditch lined with bricks and bitumen and kept filled with water from the Euphrates."<sup>632</sup>

51:45 The Lord called His people to leave Babylon because He would bring judgment on her and because He would fulfill the promises of Israel's restoration (cf. v. 6; 50:8). It was God's will for the Israelites to return to the Promised Land at the end of the Exile.

51:46-47 God announced the coming judgment on Babylon so His people would have advance warning of it even before the rumors of approaching invading enemies would reach their ears.

51:48 The whole earth and heaven would rejoice over the coming enemy of Babylon that would descend on her from the north (cf. Rev. 16:19).

Yahweh had messages for the exiles in Babylon (vv. 49-53).

51:49 Babylon would fall because she had felled Israel and many other nations.

51:50 The Israelites still alive in Babylon should remember Yahweh and return to Jerusalem before destruction came on Babylon (cf. v. 45). In the Bible remembering usually involves returning to, not just recalling.

51:51 The Israelites would be ashamed because word that pagans were desecrating the site of the temple would reach them (cf. Neh. 1:3). This would be a testimony to their sin that resulted in captivity and the destruction of the temple.

51:52 Days would come, however, when the Lord would punish Babylon's idols, and many people would die throughout the land of the Chaldeans.

51:53 No matter how heavily Babylon fortified herself, the Lord would destroy her with His appointed agents. Her attempt to ascend to heaven would prove futile (cf. Gen. 11:1-9; Isa. 14:12-14). The Babylonians built ziggurats, pyramid-shaped structures with temples on top, to get as close to heaven as possible. These structures illustrate the Babylonians' desire to

---

<sup>631</sup>See Herodotus, 1:178-81.

<sup>632</sup>Thompson, p. 765.

get to heaven by their own works. The tower of Babel was probably a ziggurat.<sup>633</sup>

It was righteous and just for Yahweh to judge Babylon (vv. 54-58). The repetition of terms from 50:2-3 and 46 forms an *inclusio* (bookends) that frames the entire oracle against Babylon.<sup>634</sup>

- 51:54-55 When the Lord would destroy the land of the Chaldeans, there would be loud cries of anguish that would replace the loud noise of her hustle and bustle. These cries would resemble the sound of the waves of the sea.
- 51:56 The Lord's appointed destroyer would capture Babylon's strong men and break her military strength because Yahweh would pay her back in full.
- 51:57 The leaders of Babylon would become as ineffective as when people get so drunk they pass out. But they would never wake up because they would die. This is what the King of all nations, Yahweh Almighty, promised.
- 51:58 The enemy would raze Babylon's broad wall and set her many huge gates on fire. The captive peoples who had toiled building Babylon's defenses would have done so for nothing. They would have exhausted themselves constructing these edifices only for them to go up in flames (cf. v. 64; Hab. 2:13).

This oracle closes with a symbolic action against Babylon (vv. 59-64).

- 51:59 The following message was one that Jeremiah gave to Seraiah the son of Neriah when he accompanied King Zedekiah on a visit to Babylon in 593 B.C.<sup>635</sup> Seraiah was Baruch's brother (cf. 32:12). The title he held, quartermaster, probably describes the official responsible for providing quarters for the king and his companions overnight as they traveled.
- 51:60 Jeremiah wrote on one scroll all his prophecies about the calamity coming on Babylon.
- 51:61-62 The prophet instructed Seraiah to read his prophecies about Babylon there publicly.<sup>636</sup> He was to announce that Yahweh had promised to destroy Babylon completely and to make it desolate. Seraiah carried out a mission to Babylon similar to Jonah's mission to Nineveh.

---

<sup>633</sup>Babylon is the Greek form of the name Babel.

<sup>634</sup>Smothers, p. 372.

<sup>635</sup>William H. Shea, "Daniel 3: Extra-Biblical Texts and the Convocation on the Plain of Dura," *Andrews University Seminary Studies* 20 (Spring 1982):29-52, believed Nebuchadnezzar summoned his vassal kings to Babylon at this time to reaffirm their loyalty following an attempted revolt in his empire a year earlier.

<sup>636</sup>Some commentators assume that Seraiah was to read the scroll only to the Jewish exiles, but there does not seem to be warrant for this limitation in the text.



51:63-64 Then Seraiah was to tie a stone to the scroll and throw it into the Euphrates River. He was to announce that as the scroll had sunk in the river so Babylon would sink and not rise again as a nation because of God's judgment on her (cf. Rev. 18:21). Babylon's saviors would only exhaust themselves trying to preserve her and to frustrate Yahweh's purpose to destroy her (cf. v. 58).

"It is remarkable that at the very time Jeremiah was advising submission to that city, he was also foretelling her final overthrow. This answers the objections of those expositors who feel that chapters 50—51 could not have been written by Jeremiah in view of his attitude toward Babylon expressed earlier in the book."<sup>637</sup>

This is the last verse in the book that Jeremiah wrote. The remaining chapter was evidently the writing of someone else, perhaps Jeremiah's secretary Baruch.

"Babylon is condemned for pride (50:13-32, 51:25-26), for idolatry (50:38, 51:17-18), and for sinning against the LORD (50:14, 24, 29; 51:5). The full extent of Babylon's sin against the LORD, other than pride and idolatry, is not clear, although it may be that Babylon's action against Judah, even though sanctioned by the LORD, may have exceeded in severity anything that the LORD had intended (cf. 50:33). In any case, for the first time in the collection of OAN [oracles against nations] in Jeremiah is a nation judged for its treatment of the people of God."<sup>638</sup>

"None of the material [in chapters 50—51] shows any awareness of the fact that Cyrus finally captured Babylon without destroying the city, but rather these chapters speak in terms of the devastation of Babylon by its enemies. No reference whatever is made to the Persians [by name]."<sup>639</sup>

Clearly some of the prophecies in these chapters were fulfilled in the overthrow of Babylon by a northern confederation of enemies in 539 B.C. But the method and extent of overthrow was quite different from what Jeremiah predicted (cf. 50:3-10, 14-16, 19-20, 26, 39-46; 51:6, 45). Why did God not completely obliterate Babylon in 539 B.C. or at some later date?

"It is at least possible that the humbling of Nebuchadrezzar, culminating in his testimony in Daniel 4:34-37, opened the door to the mercy of 539—for it is obvious from God's generous response to even an Ahab, a Manasseh, or the city of Nineveh, that he meets a change of attitude more than halfway."<sup>640</sup>

---

<sup>637</sup>Feinberg, "Jeremiah," p. 687.

<sup>638</sup>Smothers, p. 373.

<sup>639</sup>Thompson, p. 731.

<sup>640</sup>Kidner, p. 149.

Most expositors who take these prophecies literally, namely, premillennialists, look for a future fulfillment in an even more violent and permanent destruction of Babylon sometime in the future. Many of these expositors believe that Revelation 17—18 gives further revelation about that fall. Some look for a rebuilding of the ancient city and its subsequent destruction.

"The city of Babylon will be rebuilt only to be destroyed at the end of the Tribulation period before Christ returns to establish His millennial reign."<sup>641</sup>

Most premillennial scholars believe that the fall of some modern form of what Babylon represented in ancient times is in view.<sup>642</sup> I believe there will be an eschatological judgment of Babylon (Rev. 17—18), though not necessarily one that requires the rebuilding of the city. Destruction terminology, such as appears in this passage, is common in the annals of ancient Near Eastern nations. It speaks generally and hyperbolically of devastating defeat and destruction, but it did not always involve exact or detailed fulfillment.<sup>643</sup>

Amillennialists view these prophecies as having been fulfilled in the Medo-Persian overthrow and in the final spiritual destruction of the proud enemies of God's people through the salvation that Jesus Christ provided at Calvary.

#### **IV. CONCLUSION CH. 52**

This chapter has many similarities to 2 Kings 24:18—25:30 with the exception of 25:22-26, the story of Gedaliah's assassination (cf. chs. 40—41). This chapter forms a fitting conclusion to the book since it records the fulfillment of many of Jeremiah's prophecies of Jerusalem's destruction, the Exile, and the hope of restoration. Time proved Jeremiah right and the false prophets wrong. This epilogue vindicates Jeremiah's ministry.

Two unusual features mark this chapter. First, the material seems to have been borrowed from 2 Kings. A similar phenomenon appears in Isaiah 36—39 that retells the events recorded in 2 Kings 18—20 with little variation. Second, Jeremiah does not appear in this chapter. However, Jeremiah does not appear in several other chapters in this book (e.g., ch. 41). The main character in this book is not Jeremiah but God.

#### **A. THE FALL OF JERUSALEM AND THE CAPTURE OF ZEDEKIAH 52:1-16**

This is one of four accounts of the fall of Jerusalem in the Old Testament (cf. 2 Kings 25; 2 Chron. 36:11-21; Jer. 39:1-14). The repetition underlines the importance of the event.

<sup>641</sup>Dyer, "Jeremiah," p. 1199. See also idem, *The Rise of Babylon: Sign of the End Times*, pp. 161-182; Kenneth W. Allen, "The Rebuilding and Destruction of Babylon," *Bibliotheca Sacra* 133:529 (January 1976):19-27.

<sup>642</sup>Feinberg, "Jeremiah," p. 685, believed that Revelation does not describe the fall of a literal, historical Babylon but the fall of what "mystery" Babylon has represented throughout biblical history. See also H. A. Ironside, *Lectures on the Book of Revelation*, pp. 297, 302, 307.

<sup>643</sup>See Homer Heater Jr., "Do the Prophets Teach that Babylonia Will Be Rebuilt in the *Eschaton*?" *Journal of the Evangelical Theological Society* 41:1 (March 1998):36, for further specifics.

- 52:1 Zedekiah (Mattaniah, 2 Kings 24:17) was the last king of the Davidic dynasty to rule over Judah from Jerusalem. He was 21 years old when he began reigning in 597 B.C. Nebuchadnezzar selected him to rule after Zedekiah's nephew Jehoiachin proved unfaithful (2 Kings 24:17). Zedekiah ruled as Nebuchadnezzar's vassal for 11 years until the destruction of Jerusalem in 586 B.C. His mother, the queen mother, was Hamutal, the daughter of a certain Jeremiah of Libnah. The queen mother exercised considerable authority and enjoyed great prestige in ancient Near Eastern countries, which accounts for her mention here (cf. 13:18).
- 52:2 Zedekiah was one of Judah's evil kings, in Yahweh's estimation, like Jehoiakim (609-598 B.C.). Jehoiachin, Jehoiakim's immediate successor, was also a wicked king, but the writer probably did not mention Jehoiachin because he only ruled for three months (cf. 22:24-30).
- 52:3 The Lord brought hardships on Judah and Jerusalem during Jehoiakim's evil reign because of Judah's iniquity until He sent the king out of His presence into Babylon (cf. 2 Chron. 36:3). To compound Judah's troubles further, Zedekiah rebelled against Nebuchadnezzar sometime before 588 B.C., the ninth year of Zedekiah's reign (2 Kings 24:29). Because God wanted Zedekiah to submit to Nebuchadnezzar, Zedekiah's rebellion was more significantly against Yahweh.
- 52:4-5 Consequently, Nebuchadnezzar besieged Jerusalem with his army in 588 B.C. (32:24; 39:1; 2 Kings 25:1-7; Ezek. 24:1). The siege lasted until 586 B.C.
- 52:6 The people in Jerusalem ran out of food on the ninth day of the fourth month of 586 B.C. (38:9; 39:2; 2 Kings 25:3).
- 52:7 Shortly after that the Chaldeans broke into Jerusalem (39:2). The soldiers tried to flee by night by way of a concealed gate near the king's garden. They headed east for the Arabah (39:4-7).
- 52:8 However, the Chaldeans caught up with Zedekiah and his soldiers in the plains of Jericho, and the soldiers abandoned their king either deliberately or out of necessity (21:7; 32:4; 34:21; 37:17; 38:23; Lam. 4:19-20).
- 52:9 The Chaldeans took Zedekiah captive to Riblah, north of Damascus, where Nebuchadnezzar sentenced him (39:5-7; 2 Kings 25:5-7).
- 52:10-11 Nebuchadnezzar executed Zedekiah's sons as he watched as well as Zedekiah's officials who were present (cf. 39:6; 41:1). He then blinded Zedekiah, bound him with bronze shackles, and brought him to Babylon where Zedekiah spent the rest of his life in prison.
- 52:12-14 In 586 B.C. Nebuzaradan, the captain of Nebuchadnezzar's bodyguard, came to Jerusalem and burned down the temple, the royal palace, and

every sizable building.<sup>644</sup> The soldiers with Nebuzaradan also broke down the wall of the city to make it indefensible (cf. 1:10; 18:7; 31:28).

"The people of Judah had been guilty of the unthinkable, rebellion against their Babylonian suzerain, and thus suffered the consequences of their foolishness."<sup>645</sup>

52:15-16 Nebuzaradan then took some of the poorest Judahites, the rest of the residents of Jerusalem, the deserters who had defected to the Babylonians, and the remaining craftsmen captive to Babylon. However, he left some of the poorest Judahites in the land to take care of the vineyards and fields.

### **B. THE SACKING OF THE TEMPLE 52:17-23**

This section reprises in more detail the destruction of the temple just described. Before the Babylonians burned the temple, they looted it. This was the second time they had done this, the first being in 597 B.C. (27:16; 2 Kings 24:13; cf. Jer. 27:19-22).

52:17-18 The Chaldeans broke up and took to Babylon the bronze pillars at the entrance to the temple (1 Kings 7:15-22), the wheeled stands for the priests to wash their tools in (1 Kings 7:27-36), the sea (reservoir) for the water in the courtyard with which the priest washed themselves (1 Kings 7:23-26; 2 Chron. 4:6), and the utensils used in the temple service (1 Kings 7:40, 45). The sea was about 15 feet in diameter, seven and a half feet high, and three inches thick. The wheeled stands and their bowls carried about 104 gallons of water each. Thus the amount of bronze in these items was considerable.

52:19 Nebuzaradan also took to Babylon the gold and silver utensils that remained in the temple (1 Kings 7:49-50).

Jeremiah had predicted that the Babylonians would take the remaining furnishings in the temple to Babylon (27:19-22), but the false prophet Hananiah had promised that the furnishings already taken would be returned (28:3). Jeremiah was right.

52:20-23 The bronze articles, including the twelve bulls that formed a base for the sea, were so heavy their weight was beyond calculating. The hollow pillars were 27 feet high, 12 feet in circumference, and about three inches thick. The capitals on top of each pillar were an additional seven and a half feet tall, and each capital had 200 bronze pomegranates (symbols of fertility) carved on it in two rows (1 Kings 7:20, 42).<sup>646</sup>

<sup>644</sup>Evidently Nebuzaradan arrived in Jerusalem on the seventh of the month (2 Kings 25:8) and began burning the city on the tenth.

<sup>645</sup>Keown, p. 380.

<sup>646</sup>Since we do not know exactly what these capitals looked like, it is very difficult to understand how the writers of Jeremiah and Kings counted and explained the number of pomegranates on them.

### **C. THE NUMBERS DEPORTED TO BABYLON 52:24-30**

The number of exiles who went into captivity was important because it was with this group that the future of Israel lay. Their deportation also validated many of Jeremiah's prophecies that the people would go into captivity in Babylon.

52:24 Nebuzaradan took captive Seraiah, the chief priest, Zephaniah (29:24-32; 37:3), the priest who was second in authority, and three other temple officials. Seraiah's grandfather, Hilkiah, had been King Josiah's chief priest (1 Chron. 6:13-15). Seraiah's son was Ezra the reformer (Ezra 7:1). Seraiah's grandson, Joshua (Jeshua), by another son, Jehozadak, was the chief priest after the Exile when the returned Israelites rebuilt the temple (Ezra 5:2; Hag. 1:1).

"The other priest named here, Zephaniah, seems by his high position to have been the one who had passed on a threat of 'the stocks and collar' to Jeremiah over this very question of the temple vessels a few years earlier [cf. 29:24-29]. On two subsequent occasions he had been part of a deputation from the king to consult the prophet over the siege of Jerusalem [21:1-2; 37:3-5]. But Jeremiah's call to surrender had seemed too radical, and now the city's leaders had to pay the price that Babylon put on their refusal."<sup>647</sup>

52:25 Nebuzaradan also took the minister of defense, seven of Zedekiah's advisors who had not escaped, another high-ranking army officer, and 60 other men in the city who were evidently important political prisoners.

52:26-27 Nebuzaradan took all these prisoners to Nebuchadnezzar at Riblah, and the king executed them there. This completed the deportation of the Judahites from their land.

52:28 Nebuchadnezzar carried three groups of Judahites into captivity. In 597 B.C. he deported 3,023 Jews. This number may be only the adult males, or only the adult males from Jerusalem, since in 2 Kings 14 and 16 the number taken is 10, 800.

52:29 Then in 586 B.C. he took an additional 832 Jews to Babylon. Again, adult males are probably in view.

52:30 The third group of 745 people (adult males) went to Babylon under Nebuzaradan's authority in 581 B.C.<sup>648</sup> This may have happened as the result of a punitive raid conducted after the assassination of Gedaliah. The

<sup>647</sup>Kidner, p. 160.

<sup>648</sup>The first group of exiles really went to Babylon in 605 B.C. (2 Kings 21:35; 2 Chron. 28:2-3; Dan. 1:1-7). Why did the writer not mention that group? Perhaps he wanted to present only three deportations and not four since three signified a complete work of God to the Israelites. See Feinberg, "Jeremiah," p. 690, and Dyer, "Jeremiah," pp. 1205-6, for other explanations.

total number of exiles counted here was 4,600 persons. This was a very small number of people.

"Perhaps the editor wanted to make the point that Yahweh could build a new future out of a mere handful of people."<sup>649</sup>

#### **D. THE RELEASE OF JEHOIACHIN FROM PRISON 52:31-34**

This section is an almost verbatim repetition of 2 Kings 25:27-30. It closes the book on a note of hope.

- 52:31 In 562 B.C. Nebuchadnezzar's son Evilmerodach (Awel-Marduk, lit. man of Marduk; 562-560 B.C.), who succeeded his father on the throne, favored King Jehoiachin. Jehoiachin had been in prison in Babylon since 597 B.C. Evilmerodach favored Jehoiachin by bringing him out of prison. Evilmerodach may have done this in his accession year since a new king often granted favors when he assumed his throne.
- 52:32 Evilmerodach was kind to Jehoiachin and gave him a special position among the other kings that the Babylonians had imprisoned. Evilmerodach regarded Jehoiachin as Judah's king.<sup>650</sup> Evidently many of the Judean exiles did as well (cf. 22:24-30).
- 52:33-34 Jehoiachin left prison. He even took his meals with Evilmerodach and received a daily allowance for the rest of his life, probably to support his family. His personal experience was a foreview of the national experience of the Israelites.

"There is considerable theological significance in these four verses. The fact that Jehoiachin lived on long after the exile and that he was finally released from prison may have seemed like the first signs of the fulfilment [*sic*] of Jeremiah's promise of a day of restoration. To the last, the future of Israel is seen as lying with the exiles in Babylon and not with those in Egypt or in their old homeland."<sup>651</sup>

However, Jeremiah had prophesied that none of Jehoiachin's sons would rule over Judah (22:24-30). So while Evilmerodach's treatment of Jehoiachin was encouraging, the future would require a supernatural act of God to perpetuate the Davidic dynasty and produce Messiah.

"In its present context the chapter seems to say: the divine word both has been fulfilled—and will be fulfilled!"<sup>652</sup>

---

<sup>649</sup>Thompson, p. 783.

<sup>650</sup>See Pritchard, ed., p. 308.

<sup>651</sup>Thompson, p. 784.

<sup>652</sup>Bright, *Jeremiah*, p. 370.

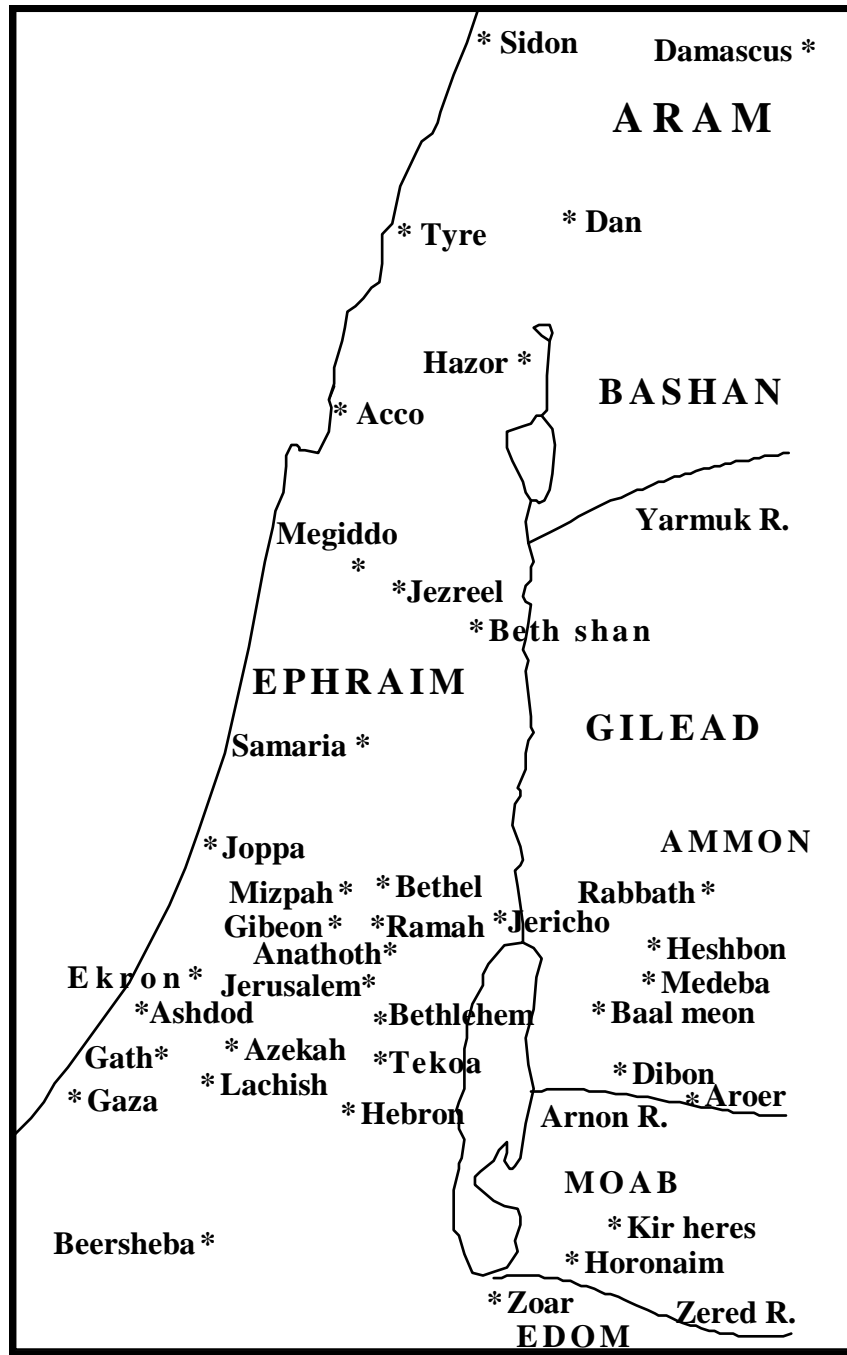

CANAAN IN JEREMIAH'S TIMES

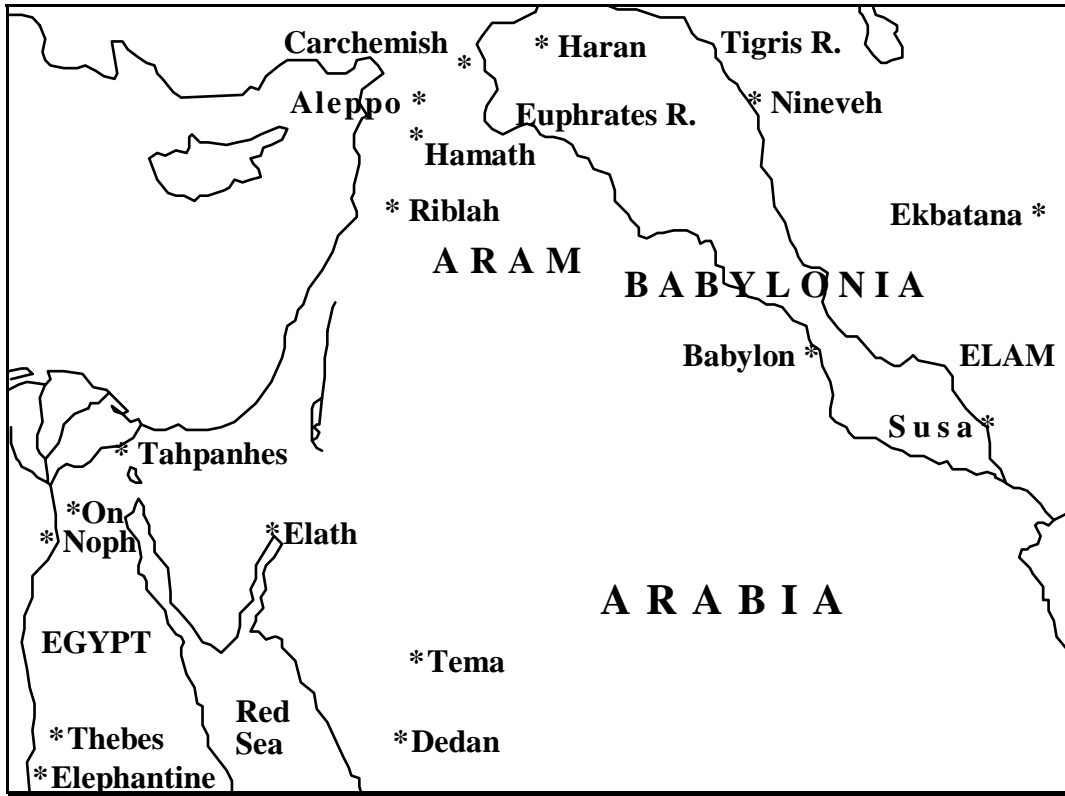

THE ANCIENT NEAR EAST IN JEREMIAH'S TIMES



## Bibliography

- Aharoni, Yohanan, and Michael Avi-Yonah. *The Macmillan Bible Atlas*. Revised ed. London: Collier Macmillan Publishers; and New York: Macmillan Publishers Co., 1977.
- Albright, William Foxwell. *The Archaeology of Palestine*. Revised ed. Baltimore: Penguin Books Inc., 1956.
- \_\_\_\_\_. "The Danish Excavations at Shiloh." *Bulletin of the American Schools of Oriental Research* 9, pp. 10-11.
- Allen, Kenneth W. "The Rebuilding and Destruction of Babylon." *Bibliotheca Sacra* 133:529 (January 1976):19-27.
- Archer, Gleason L., Jr. *A Survey of Old Testament Introduction*. Revised ed. Chicago: Moody Press, 1974.
- Auld, A Graeme. "Prophets and Prophecy in Jeremiah and Kings." *Zeitschrift für die Alttestamentliche Wissenschaft* 96:1 (1984):66-82.
- Bailey, K. E., and W. L. Holladay. "The 'Young Camel' and 'Wild Ass' in Jer. 2:23-25." *Vetus Testamentum* 18 (1968):256-60.
- Barker, Kenneth L. "Jeremiah's Ministry and Ours." *Bibliotheca Sacra* 127:507 (July 1970):223-31.
- Blaising, Craig A. "The Fulfillment of the Biblical Covenants." In *Progressive Dispensationalism*, pp. 174-211. By Craig A. Blaising and Darrell L. Bock. Wheaton: Victor Books, 1993.
- \_\_\_\_\_. "The Kingdom of God in the New Testament." In *Progressive Dispensationalism*, pp. 232-83. By Craig A. Blaising and Darrell L. Bock. Wheaton: Victor Books, 1993.
- Bright, John. *A History of Israel*. Philadelphia: Westminster Press, 1959.
- \_\_\_\_\_. *Jeremiah*. Anchor Bible series. Garden City, N.Y.: Doubleday, 1965.
- Brueggemann, Walter A. "The Epistemological Crisis of Israel's Two Histories (Jer 9:22-23)." In *Israelite Wisdom: Theological and Literary Essays in Honor of Samuel Terrien*, pp. 85-105. Edited by John G. Gammie, et al. New York: Scholars Press, Union Theological Seminary, 1978.

- Carroll, Robert P. *Jeremiah*. Old Testament Library series. Philadelphia: Westminster Press, 1986.
- Chafer, Lewis Sperry. *Systematic Theology*. 8 vols. Dallas: Dallas Seminary Press, 1947-48.
- Chisholm, Robert B., Jr. "Does God Deceive?" *Bibliotheca Sacra* 155:617 (January-March 1998):11-28.
- \_\_\_\_\_. *Handbook on the Prophets*. Grand Rapids: Baker Book House, 2002.
- \_\_\_\_\_. "A Theology of Jeremiah and Lamentations." In *A Biblical Theology of the Old Testament*, pp. 341-63. Edited by Roy B. Zuck. Chicago: Moody Press, 1991.
- Constable, Thomas L. *Talking to God: What the Bible Teaches about Prayer*. Grand Rapids: Baker Book House, 1995; reprint ed., Eugene, Oreg.: Wipf & Stock Publishers, 2005.
- \_\_\_\_\_. "What Prayer Will and Will Not Change." In *Essays in Honor of J. Dwight Pentecost*, pp. 99-113. Edited by Stanley D. Toussaint and Charles H. Dyer. Chicago: Moody Press, 1986.
- Cowley, A. *Aramaic Papyri of the Fifth Century B.C.* Oxford: Clarendon Press, 1923.
- Craigie, Peter C.; Page H. Kelley; and Joel F. Drinkard Jr. *Jeremiah 1—25*. Word Biblical Commentery series. Dallas: Word Books, 1991.
- Decker, Rodney J. "The Church's Relationship to the New Covenant." *Bibliotheca Sacra* 152:607 (July-September 1995):290-305.
- de Vaux, Roland. *Ancient Israel: Its Life and Institutions*. 2 vols. Translated by John McHugh. New York: McGraw-Hill, 1961.
- Dillard, Raymond B., and Tremper Longman III. *An Introduction to the Old Testament*. Grand Rapids: Zondervan Publishing House, 1994.
- Duhm, Berhard. *Das Buch Jeremia*. Kurzer Hand-Commentar zum Alten Testament. Tübingen/Leipzig, Germany: Mohr (Siebeck), 1901.
- Dyer, Charles H. "Jeremiah." In *The Bible Knowledge Commentary: Old Testament*, pp. 1123-1206. Edited by John F. Walvoord and Roy B. Zuck. Wheaton: Scripture Press Publications, Victor Books, 1985.
- \_\_\_\_\_. *The Rise of Babylon: Sign of the End Times*. Wheaton: Tyndale House Publishers, 1991.

- \_\_\_\_\_. "Waistbands, Water, and the Word of God: Where Did Jeremiah Bury His Girdle?" In *Integrity of Heart, Skillfulness of Hands: Biblical and Leadership Studies in Honor of Donald K. Campbell*, pp. 62-81. Edited by Charles H. Dyer and Roy B. Zuck. Chicago: Moody Press, 1994.
- Dyer, Charles H., and Eugene H. Merrill. *The Old Testament Explorer*. Nashville: Word Publishing, 2001. Reissued as *Nelson's Old Testament Survey*. Nashville: Thomas Nelson Publishers, 1999.
- Feinberg, Charles Lee. "Jeremiah." In *Isaiah-Ezekiel*. Vol. 6 of *The Expositor's Bible Commentary*. 12 vols. Edited by Frank E. Gaebelin and Richard P. Polcyn. Grand Rapids: Zondervan Publishing House, 1986.
- \_\_\_\_\_. "Jeremiah 31:22: Proverb, Promise, or Prophecy?" *Bibliotheca Sacra* 123:492 (October 1996): 315-24, and 124:493 (January 1967):16-21.
- Freeman, Hobart E. *An Introduction to the Old Testament Prophets*. Chicago: Moody Press, 1968.
- Fretheim, Terence. *The Suffering of God*. Philadelphia: Fortress Press, 1984.
- Goddard, Burton L. *Meet Jeremiah: A Devotional Commentary*. Grand Rapids: Kregel Publications, 1992.
- Graybill, John F. "Jeremiah." In *The Wycliffe Bible Commentary*, pp. 655-94. Edited by Charles F. Pfeiffer and Everett F. Harrison. Chicago: Moody Press, 1962.
- Green, A. R. W. *The Role of Human Sacrifice in the Ancient Near East*. Missoula, Mont.: Scholars Press, 1975.
- Harrison, R. K. *Introduction to the Old Testament*. Grand Rapids: Wm. B. Eerdmans Publishing Co., 1969.
- \_\_\_\_\_. *Jeremiah and Lamentations: An Introduction and Commentary*. Tyndale Old Testament Commentaries series. Leicester, Eng. and Downers Grove, Ill.: InterVarsity Press, 1973.
- Hays, J. Daniel. "The Cushites: A Black Nation in the Bible." *Bibliotheca Sacra* 153:612 (October-December 1996):396-409.
- Heater, Homer, Jr. "Do the Prophets Teach that Babylonia Will Be Rebuilt in the Eschaton?" *Journal of the Evangelical Theological Society* 41:1 (March 1998):23-43.
- Henderson, E. *The Book of the Prophet Jeremiah*. Andover, Mass.: W. F. Draper, 1868.

- Hengstenberg, E. W. "The New Covenant." In *Classical Evangelical Essays in Old Testament Interpretation*, pp. 237-51. Compiled and edited by Walter C. Kaiser Jr. Grand Rapids: Baker Book House, 1972.
- Herodotus. 4 vols. With an English translation by A. D. Godley. The Loeb Classical Library. Cambridge: Harvard University Press, and London: William Heinemann, 1960.
- Hester, Dennis J., compiler. *The Vance Havner Quotebook*. Grand Rapids: Baker Book House, 1986.
- Hillers, D. R. *Treaty-Curses and the Old Testament Prophets*. Biblica et orientalia 16. Rome: Pontifical Biblical Institute, 1964.
- Holladay, W. L. *Jeremiah*. 2 vols. Hermeneia series. Philadelphia and Minneapolis: Augsburg Fortress Press, 1986, 1989.
- The Interpreter's Dictionary of the Bible*. S.v. "Stocks," by M. Greenberg, 4:443.
- Ironside, Harry A. *Lectures on the Book of Revelation*. New York: Loizeaux Brothers Publishers, 1930.
- Isbell, C. D. "2 Kings 22:3—23:24 and Jeremiah 36: A Stylistic Comparison." *Journal for the Study of the Old Testament* 8 (1978):33-45.
- Jensen, Irving L. *Jeremiah and Lamentations*. Everyman's Bible Commentary series. Chicago: Moody Press, 1966 (Jeremiah), 1972 (Lamentations).
- Johnston, R. H. "The Biblical Potter." *Biblical Archaeologist* 37:4 (1974):86-106.
- Josephus, Flavius. *The Works of Flavius Josephus*. Translated by William Whiston. *Antiquities of the Jews*. London: T. Nelson and Sons, 1866.
- Kaiser, Walter C., Jr. "Evidence from Jeremiah." In *A Case for Premillennialism: A New Consensus*, pp. 103-17. Edited by Donald K. Campbell and Jeffrey L. Townsend. Chicago: Moody Press, 1992.
- Kaminsky, Joel S. *Corporate Responsibility in the Hebrew Bible*. Sheffield, England: Sheffield Academic Press, 1995.
- Keil, Carl Friedrich. *The Prophecies of Jeremiah*. Translated by David Patrick. Biblical Commentary on the Old Testament. Reprint ed. 2 vols. Grand Rapids: Wm. B. Eerdmans Publishing Co., 1960.
- Keown, Gerald L.; Pamela J. Scalise; and Thomas G. Smothers. *Jeremiah 26—52*. Word Biblical Commentary series. Dallas: Word Books, 1995.

Kessler, M. "Form Critical Suggestions on Jer 36." *Catholic Biblical Quarterly* 28 (1966):389-401.

\_\_\_\_\_. "Rhetoric in Jeremiah 50 and 51." *Semitics* 3 (1973):3-32.

\_\_\_\_\_. "The Significance of Jer 36." *Zeitschrift für die Alttestamentliche Wissenschaft* 81 (1969):381-83.

Kidner, Derek. *The Message of Jeremiah*. The Bible Speaks Today series. Leicester, Eng. and Downers Grove, Ill.: Inter-Varsity Press, 1987.

King, P. J. *Jeremiah: An Archaeological Companion*. Louisville: Westminster John Knox, 1993.

Kjaer, Hans. "The Excavation of Shiloh 1929." *Journal of the Palestine Oriental Society* 10:2-3 (1930):87-174.

Lange, John Peter, ed. *A Commentary on the Holy Scriptures*. 25 vols. New York: Charles Scribner, 1865-80; reprint ed., Grand Rapids: Zondervan Publishing House, n. d. Vol. 6: *The Book of the Prophet Jeremiah Theologically and Homiletically Expounded*, by E. W. Eduard Naegelsback. Translated, enlarged, and edited by Samuel Ralph Asbury.

Master, John R. "The New Covenant." In *Issues in Dispensationalism*, pp. 93-110. Edited by Wesley R. Willis and John R. Master. Chicago: Moody Press, 1994.

McKane, William. "Jeremiah 13:12-14: A Problematic Proverb." In *Israelite Wisdom: Theological and Literary Essays in Honor of Samuel Terrien*, pp. 107-20. Edited by John G. Gammie, et al. New York: Scholars Press, Union Theological Seminary, 1978.

Meier, S. A. *The Messenger in the Ancient Semitic World*. Harvard Semitic Monograph 45. Atlanta: Scholars Press, 1988.

Merrill, Eugene H. *Kingdom of Priests: A History of Old Testament Israel*. Grand Rapids: Baker Book House, 1987.

Morgan, G. Campbell. *Living Messages of the Books of the Bible*. 2 vols. New York: Fleming H. Revell Co., 1912.

Mowinckel, Sigmund. *Zur Komposition des Buches Jeremia*. Kristiania: J. Dybwad, 1914.

*The New Bible Dictionary*, 1962 ed. S.v. "Archaeology," by D. J. Wiseman, pp. 60-76.

- \_\_\_\_\_. S.v. "Chaldaeae, Chaldeans," by D. J. Wiseman, pp. 203-4.
- \_\_\_\_\_. S.v. "Slave, Slavery," by Kenneth A. Kitchen, pp. 1195-99.
- The New Scofield Reference Bible*. Edited by Frank E. Gaebelein, William Culbertson, et al. New York: Oxford University Press, 1967.
- Paul, Shalom M. "Cuneiform Light on Jer. 9, 20." *Biblica* 49 (1968):373-76.
- Pentecost, J. Dwight. *Thy Kingdom Come*. Wheaton: Scripture Press Publications, Victor Books, 1990.
- Pritchard, James B. *Ancient Near Eastern Texts*. 2nd. ed. Princeton: Princeton University Press, 1955.
- Ryrie, Charles Caldwell. *The Basis of the Premillennial Faith*. Neptune, NJ: Loizeaux Brothers, 1953.
- Schaeffer, Francis A. *Death in the City*. Chicago: Inter-Varsity Press, 1969.
- Shea, William H. "Daniel 3: Extra-Biblical Texts and the Convocation on the Plain of Dura." *Andrews University Seminary Studies* 20 (Spring 1982):29-52.
- Sprinkle, Joe M. "Old Testament Perspectives on Divorce and Remarriage." *Journal of the Evangelical Theological Society* 40:4 (December 1997):542-43.
- Stuart, Douglas K. "The Prophetic Ideal of Government in the Restoration Era." In *Israel's Apostasy and Restoration: Essays in Honor of Roland K. Harrison*, pp. 283-92. Edited by Avraham Gileadi. Grand Rapids: Baker Book House, 1988.
- Swetnam, J. "Some Observations on the Background of *saddiq* in Jeremiah 23:5a." *Biblica* 46:1 (1965):29-40.
- Thiele, Edwin R. *A Chronology of the Hebrew Kings*. Contemporary Evangelical Perspectives series. Grand Rapids: Zondervan Publishing House, 1977.
- Thompson, John Arthur. *The Book of Jeremiah*. International Commentary on the Old Testament series. Grand Rapids: Wm. B. Eerdmans Publishing Co., 1980.
- Thomson, W. H. *The Land and the Book; or, Biblical Illustrations Drawn from the Manners and Customs, the Scenes and Scenery of the Holy Land*. 2 vols. New York: Harper & Brothers, 1873.
- Tov, Emanuel. "The Literary History of the Book of Jeremiah in the Light of Its Textual History." In *Empirical Models for Biblical Criticism*, pp. 211-37. Edited by J. Tigay. Philadelphia: University of Pennsylvania Press, 1985.

- Ware, Bruce A. "The New Covenant and the People(s) of God." In *Dispensationalism, Israel and the Church: The Search for Definition*, pp. 68-97. Edited by Craig A. Blaising and Darrell L. Bock. Grand Rapids: Zondervan Publishing House, 1992.
- Walvoord, John F. "The New Covenant." In *Integrity of Heart, Skillfulness of Hands: Biblical and Leadership Studies in Honor of Donald K. Campbell*, pp. 186-200. Edited by Charles H. Dyer and Roy B. Zuck. Grand Rapids: Baker Book House, 1994.
- Watts, John D. W. "Babylonian Idolatry in the Prophets As a False Socio-Economic System." In *Israel's Apostasy and Restoration: Essays in Honor of Roland K. Harrison*, pp. 115-22. Edited by Avraham Gileadi. Grand Rapids: Baker Book House, 1988.
- Weinfeld, Moshe. "The Loyalty Oath in the Ancient Near East." *Ugarit-Forschungen* 8 (1976):379-414.
- Wiersbe, Warren W. "Jeremiah." In *The Bible Exposition Commentary/Prophets*, pp. 73-150. Colorado Springs, Colo.: Cook Communications Ministries; and Eastbourne, England: Kingsway Communications Ltd., 2002.
- Wiseman, Donald J. *Chronicles of Chaldean Kings (626-556 B.C.) in the British Museum*. London: Trustees of the British Museum, 1956.
- Wittstruck, T. "The Influence of Treaty Curse Imagery on the Beast Imagery of Daniel 7." *Journal of Biblical Literature* 97 (1978):100-102.
- Wood, Fred M. *Fire in My Bones*. Nashville: Broadman Press, 1959.
- Wood, Leon J. *The Prophets of Israel*. Grand Rapids: Baker Book House, 1979.
- Workman, G. C. *The Text of Jeremiah*. Edinburgh: T. & T. Clark, 1889.
- Wright, George Ernest. "The Archaeology of Palestine." In *The Bible and the Ancient Near East*, pp. 73-112. Edited by G. E. Wright. London: Routledge and Kegan Paul, 1961.
- Yates, Gary E. "Narrative Parallelism and the 'Jehoiakim Frame': A Reading Strategy for Jeremiah 26—45." *Journal of the Evangelical Theological Society* 48:2 (June 2005):263-281.
- Young, Edward J. *The Book of Isaiah*. 3 vols. The New International Commentary on the Old Testament series. Grand Rapids: Wm. B. Eerdmans Publishing Co., 1965, 1969, 1972.

\_\_\_\_\_. *An Introduction to the Old Testament*. Revised ed. Grand Rapids: Wm. B. Eerdmans Publishing Co., 1960.

Young, Rodger C. "When Did Jerusalem Fall?" *Journal of the Evangelical Theological Society* 47:1 (March 2004):21-38.